

Tara V Shanbhag • Smita Shenoy • Veena Nayak

PHARMACOLOGY

for Dentistry

2ND EDITION

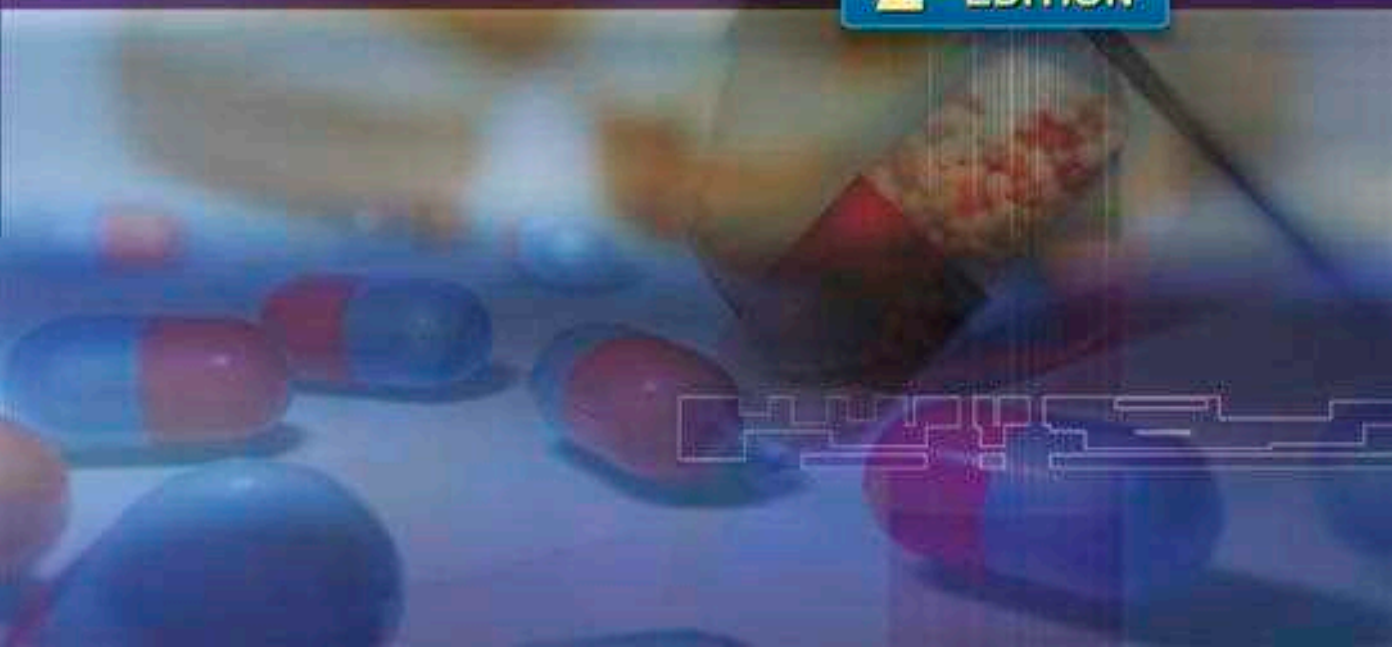

Pharmacology for Dentistry

This page intentionally left blank

Pharmacology for Dentistry

Second Edition

Tara V Shanbhag MD

Professor, Department of Pharmacology
Srinivas Institute of Medical Sciences and
Research Centre, Mukka, Surathkal, Mangalore, Karnataka
Formerly, Professor, Department of Pharmacology
Kasturba Medical College, Manipal University
Manipal, Karnataka

Smita Shenoy MD

Additional Professor, Department of Pharmacology
Kasturba Medical College, Manipal University
Manipal, Karnataka

Veena Nayak MD

Associate Professor, Department of Pharmacology
Kasturba Medical College, Manipal University
Manipal, Karnataka



ELSEVIER
A division of

Reed Elsevier India Private Limited

Pharmacology for Dentistry, 2/e

Shanbhag, Shenoy and Nayak

© 2014 Reed Elsevier India Private Limited. **All rights reserved.**

No part of this publication may be reproduced or transmitted in any form or by any means, electronic or mechanical, including photocopying, recording, or any information storage and retrieval system, without permission in writing from the Publisher.

This book and the individual contributions contained in it are protected under copyright by the Publisher (other than as may be noted herein).

ISBN: 978-81-312-3455-6

Notices

Knowledge and best practice in this field are constantly changing. As new research and experience broaden our understanding, changes in research methods, professional practices, or medical treatment may become necessary. Practitioners and researchers must always rely on their own experience and knowledge in evaluating and using any information, methods, compounds, or experiments described herein. In using such information or methods they should be mindful of their own safety and the safety of others, including parties for whom they have a professional responsibility.

With respect to any drug or pharmaceutical products identified, readers are advised to check the most current information provided (i) on procedures featured or (ii) by the manufacturer of each product to be administered, to verify the recommended dose or formula, the method and duration of administration, and contraindications. It is the responsibility of practitioners, relying on their own experience and knowledge of their patients, to make diagnoses, to determine dosages and the best treatment for each individual patient, and to take all appropriate safety precautions.

To the fullest extent of the law, neither the Publisher nor the authors, contributors, or editors, assume any liability for any injury and/or damage to persons or property as a matter of products liability, negligence or otherwise, or from any use or operation of any methods, products, instructions, or ideas contained in the material herein.

Please consult full prescribing information before issuing prescription for any product mentioned in this publication.

The Publisher

Published by Elsevier, a division of Reed Elsevier India Private Limited

Registered Office: 305, Rohit House, 3 Tolstoy Marg, New Delhi-110 001

Corporate Office: 14th Floor, Building No. 10B, DLF Cyber City, Phase II, Gurgaon-122 002, Haryana, India

Senior Content Strategist: Nimisha Goswami

Senior Project Manager-Education Solutions: Shabina Nasim

Project Coordinator: Shравan Kumar

Copy Editor: Richa Srivastava

Manager-Publishing Operations: Sunil Kumar

Production Manager: NC Pant

Cover Designer: Raman Kumar

Typeset by Chitra Computers, New Delhi

Printed and bound at

Foreword to the First Edition

Pharmacology has undergone phenomenal growth in terms of information on mechanism of action and clinical application of drugs. The main objective of teaching pharmacology is to provide a rationale for choosing and prescribing drugs skillfully to relieve patient's sufferings. Dental practitioners use drugs not only for dental problems but also for management of medical emergency during dental treatment. It is not enough for dentists to have knowledge on the use of these drugs, they should also have a sound knowledge of pharmacology of other drugs in order to prevent the chances of drug interactions, which the patient may be taking for co-morbid conditions.

Pharmacology for Dental Students covers drugs acting on all systems in a methodical way. The book starts with the general pharmacological principles with which all prescribers must be conversant. This is followed by systemic pharmacology, i.e. drugs acting on various systems. The authors have organized each chapter systematically beginning with definitions, classification of drugs, description on various groups of drugs followed by management or treatment of various conditions and finally a few model questions.

A separate chapter on Dental Pharmacology covers various preparations that dentists use in their day-to-day practice. Enough coverage is given to manage medical emergencies during dental practice such as anaphylactic shock, bronchial asthma, angina pectoris, seizures, etc. Lastly, the appendix covers a list of commonly prescribed drugs with dose and route of administration.

My best wishes to the authors.

Dr K L Bairy
Professor and Head
Department of Pharmacology
Kasturba Medical College
Manipal University
Manipal, Karnataka, India

This page intentionally left blank

Preface to the Second Edition

The main objective of the Second Edition of *Pharmacology for Dental Students* (now, more aptly named as *Pharmacology for Dentistry*) is significant expansion and revision of the existing first edition.

In this book, importance is given to dental implications of many drugs and proper guidelines to tackle the emergency conditions that may occur during dental procedures. The style and presentation form has been maintained – simple diagrams, self-explanatory flowcharts, tables and student friendly mnemonics. Some new topics like Drug Dosage Forms and Pharmacovigilance have been introduced. Treatment schedules have been revised as per WHO guidelines. This book also includes practical aspects such as prescription writing, drug interactions, emergency management, etc. Thorough changes have been made in all chapters.

This extensively revised edition will be useful not only for the dental students but also for the practicing dentists.

We hope that this edition meets the requirements of undergraduate dental students and serves as a better learning tool. We would sincerely appreciate critical appraisal of this manual and suggestions for improvement in future.

**Tara V Shanbhag
Smita Shenoy
Veena Nayak**

This page intentionally left blank

Preface to the First Edition

Pharmacology is a vast subject with many crucial aspects related to drugs, their composition, uses, effects, interactions, etc. This makes the subject complicated and difficult to comprehend.

This book meets the requirement of the syllabus proposed by the Dental Council of India. The text is presented in a simple, precise and point-wise manner. This style of presentation would not only make it easier for students to understand the subject in a better manner, but would also help them to quickly review and revise the subject before examination. Further, to make learning simpler and comprehension easier for the students, numerous tables, flowcharts and line diagrams have been included.

We are grateful to Prof. K L Bairy for writing the Foreword.

We would appreciate critical appraisal of this book and suggestions for improvement.

Tara V Shanbhag
Smita Shenoy
Veena Nayak

Brief Contents

	<i>Foreword to the First Edition</i>	v
	<i>Preface to the Second Edition</i>	vii
	<i>Preface to the First Edition</i>	ix
Chapter 1	General Pharmacology	1
Chapter 2	Drug Dosage Forms	43
Chapter 3	Drugs Acting on Autonomic Nervous System	47
Chapter 4	Drugs Affecting Cardiovascular Function	97
Chapter 5	Renal Pharmacology	129
Chapter 6	Drugs Acting on Central Nervous System	141
Chapter 7	Autacoids and Respiratory System	197
Chapter 8	Drugs Used in the Treatment of Gastrointestinal Diseases	221
Chapter 9	Drugs Acting on Blood and Blood-forming Organs	241
Chapter 10	Endocrine Pharmacology	259
Chapter 11	Chemotherapy	295
Chapter 12	Dental Pharmacology	367
Chapter 13	Miscellaneous Drugs	381
	<i>Appendix</i>	<i>393</i>
	<i>Index</i>	<i>403</i>

Contents

<i>Foreword to the First Edition</i>	<i>v</i>	
<i>Preface to the Second Edition</i>	<i>vii</i>	
<i>Preface to the First Edition</i>	<i>ix</i>	
Chapter 1	General Pharmacology	1
	Introduction (Definitions and Sources of Drugs)	1
	Sources of Drug Information	2
	Sources of Drugs	3
	Routes of Drug Administration	3
	Pharmacokinetics	9
	Pharmacodynamics	23
	Adverse Drug Effects	36
Chapter 2	Drug Dosage Forms	43
	Solid Dosage Forms	43
	Semisolid Dosage Forms	44
	Liquid Dosage Forms	44
	Injectable Dosage Forms	45
	New Drug-Delivery Systems	45
Chapter 3	Drugs Acting on Autonomic Nervous System	47
	Introduction to Autonomic Pharmacology	47
	Cholinergic System	48
	Cholinergic Agents (Cholinomimetics, Parasympathomimetics)	51
	Anticholinergic Agents (Cholinergic Receptor Blockers)	63
	Skeletal Muscle Relaxants	70
	Adrenergic Agonists (Sympathomimetic Agents)	75
	Adrenergic Receptor Blockers	88

Chapter 4	Drugs Affecting Cardiovascular Function	97
	Hypertension	97
	Antianginal Drugs	109
	Drugs Used in Congestive Cardiac Failure	117
	Plasma Expanders	125
	Shock	126
Chapter 5	Renal Pharmacology	129
	Diuretics	130
	Antidiuretics	138
Chapter 6	Drugs Acting on Central Nervous System	141
	Neurotransmitters and Central Nervous System	141
	Sedatives and Hypnotics	142
	General Anaesthetics	149
	Local Anaesthetics	157
	Alcohols (Ethanol and Methanol)	165
	Antiepileptic Drugs	168
	Opioid Analgesics	177
	Psychopharmacology	186
	Antipsychotics	187
	Antianxiety Agents	190
	Antidepressants	190
	Drugs for Bipolar Disorder	194
Chapter 7	Autacoids and Respiratory System	197
	Histamine and Antihistamines	197
	Prostaglandins and Leukotrienes (Eicosanoids)	201
	Nonsteroidal Antiinflammatory Drugs	203
	Drugs Used in Treatment of Cough	211
	Drugs Used in Treatment of Bronchial Asthma	213

Chapter 8	Drugs Used in the Treatment of Gastrointestinal Diseases	221
	Emetics and Antiemetics	221
	Antidiarrhoeal Agents	228
	Laxatives (Purgatives, Cathartics)	229
	Pharmacotherapy of Peptic Ulcer and Gastroesophageal Reflux Disease	232
Chapter 9	Drugs Acting on Blood and Blood-forming Organs	241
	Drugs Affecting Coagulation and Bleeding	241
	Haematinics	252
Chapter 10	Endocrine Pharmacology	259
	Introduction	259
	Hypothalamic and Pituitary Hormones	260
	Thyroid Hormones and Antithyroid Drugs	261
	Anabolic Steroids	266
	Corticosteroids	267
	Insulin and Oral Antidiabetic Agents	276
	Agents Affecting Calcium Balance	288
Chapter 11	Chemotherapy	295
	General Considerations	295
	Sulphonamides	302
	Cotrimoxazole	304
	Quinolones	306
	β -Lactam Antibiotics	308
	Penicillins	308
	Cephalosporins	315
	Carbapenems	317
	Monobactams	318
	Aminoglycosides	318
	Tetracyclines	322

	Chloramphenicol	324
	Macrolides	326
	Miscellaneous Antibacterial Agents	329
	Antitubercular Drugs	331
	Antileprotic Drugs	337
	Antifungal Agents	340
	Antiviral Agents	347
	Antiretroviral Agents	350
	Antimalarial Drugs	353
	Nitroimidazoles	355
	Anticancer Drugs	357
Chapter 12	Dental Pharmacology	367
	Fluorides	367
	Astringents	369
	Desensitising Agents	369
	Anticaries Agents	370
	Antiplaque Agents	371
	Dentifrices	373
	Disclosing Agents	375
	Bleaching Agents	376
	Obtundents	377
	Mummifying Agents	378
	Mouthwashes (Mouthrinses)	378
Chapter 13	Miscellaneous Drugs	381
	Chelating Agents	381
	Antiseptics and Disinfectants	382
	Vitamins	387
	Drug Treatment of Medical Emergencies	391
	Dental Tray (Emergency Drug Kit)	392

Appendix	393
Commonly Used Abbreviations	393
Commonly Prescribed Drugs	393
Index	403

This page intentionally left blank

INTRODUCTION (DEFINITIONS AND SOURCES OF DRUGS)

Pharmacology	It is the science that deals with the effects of drugs on living system.
Drug	World Health Organisation (WHO) defines <i>drug</i> as ‘any substance or product that is used or intended to be used to modify or explore physiological systems or pathological states for the benefit of the recipient’.
Pharmacokinetics	It means the movement of the drug within the body; it includes the processes of absorption (A), distribution (D), metabolism (M) and excretion (E). It means ‘what the body does to the drug’.
Pharmacodynamics	It is the study of drugs—their mechanism of action, pharmacological actions and their adverse effects. It covers all the aspects relating to ‘what the drug does to the body’.
Pharmacy	It is the branch of science that deals with the preparation, preservation, standardization, compounding and proper utilization of drugs.
Therapeutics	It is the aspect of medicine that is concerned with the treatment of diseases.
Chemotherapy	It deals with the treatment of infectious diseases/cancer with chemical compounds that have relatively selective toxicity for the infecting organism/cancer cells.
Toxicology	It is the study of poisons, their actions, detection, prevention and the treatment of poisoning.
Clinical pharmacology	It is the systematic study of a drug in humans—both in healthy volunteers and patients. It includes the evaluation of pharmacokinetic and pharmacodynamic data, safety, efficacy and adverse effects of a drug by comparative clinical trials.
Essential medicine	According to WHO, <i>essential drugs</i> are ‘those that satisfy the healthcare needs of majority of the population’. They should be of assured quality, available at all times in adequate quantities and in appropriate dosage forms. They should be selected with regard to disease prevalence in a country, evidence on safety and efficacy, and comparative cost-effectiveness. Examples are iron and folic acid preparation for anaemia in pregnancy, antitubercular drugs like isoniazid, rifampicin, pyrazinamide, ethambutol, etc.

- Orphan drugs** Drugs that are used for the diagnosis, treatment or prevention of rare diseases. The expenses incurred during the development, manufacture and marketing of drug cannot be recovered from selling the drugs by the pharmaceutical company, e.g. digoxin antibody (for digoxin toxicity), fomepizole (for methyl alcohol poisoning), etc.
- Over-the-counter drugs (OTC drugs)** OTC or nonprescription drugs are the drugs that can be sold to a patient without the need for a doctor's prescription, e.g. paracetamol, antacids, etc.
- Prescription drugs** These are the drugs that can be obtained only upon producing a prescription by a registered medical practitioner, e.g. antibiotics, antipsychotics, etc.

■ Sources of Drug Information

Pharmacopoeia: It is a book that contains a list of established and officially approved drugs having description of their physical and chemical characteristics with tests for their identification, purity, methods of storage, etc. Some of the pharmacopoeias are the Indian Pharmacopoeia (IP), the British Pharmacopoeia (BP), the European Pharmacopoeia and the United States Pharmacopoeia (USP). Other sources of drug information are National Formulary (NF), Martindale—the Extra Pharmacopoeia, Physician's Desk Reference (PDR), American Medical Association Drug Evaluation, textbooks and journals of Pharmacology and therapeutics, drug bulletins, databases like drug Micromedex, Medline, Cochrane Library, etc.

Formulary: It provides information about available drugs—their use, dosage, adverse effects, contraindications, precautions, warnings and guidance on selecting right drug for a range of conditions.

■ Drug Nomenclature

Drugs usually have three types of names. They are as follows:

Chemical name	Non-proprietary name	Proprietary/brand name
Acetylsalicylic acid	Aspirin	Disprin, Ecosprin
<i>N</i> -acetyl- <i>p</i> -aminophenol	Paracetamol	Crocin, Metacin, Tylenol

- 1. Chemical name:** It denotes the chemical structure of the drug, e.g. *acetylsalicylic acid* is the chemical name of aspirin and *N*-acetyl-*p*-aminophenol for paracetamol. It is not suitable for use in a prescription.
- 2. Non-proprietary name:** It is assigned by a competent scientific body/authority, e.g. the United States Adopted Name (USAN) council. It is commonly used as generic name. It should be used ideally in prescriptions because it is economical and uniform all over the world than the branded counterparts, e.g. aspirin and paracetamol are generic names.
- 3. Proprietary name (brand name):** It is given by the drug manufacturers. Brand names are short and easy to recall. A drug usually has many brand names—it may have different names within a country and in different countries. Brand names can also be used in prescriptions, e.g. Disprin is a brand name of aspirin; Crocin is a brand name of paracetamol.

Sources of Drugs

They are natural, semisynthetic and synthetic. Natural resources are plants, animals, minerals, microorganisms, etc. Semisynthetic drugs are obtained from natural sources and are chemically modified later. Synthetic drugs are produced artificially. The different sources of drugs are:

- a. **Plants:**
 - i. **Alkaloids**, e.g. morphine, atropine, quinine, reserpine, ephedrine.
 - ii. **Glycosides**, e.g. digoxin, digitoxin.
- b. **Animals:** Insulin, heparin.
- c. **Minerals:** Ferrous sulphate, magnesium sulphate.
- d. **Microorganisms:** Penicillin, streptomycin, griseofulvin.
- e. **Semisynthetic:** Hydromorphone, hydrocodone.
- f. **Synthetic:** Most of the drugs used today are synthetic, e.g. aspirin, paracetamol.

Drugs are also produced by **genetic engineering (DNA recombinant technology)**, e.g. human insulin, human growth hormone, hepatitis B vaccine.

ROUTES OF DRUG ADMINISTRATION

Most of the drugs can be administered by different routes. Drug- and patient-related factors determine the selection of routes for drug administration. The factors are:

1. Characteristics of the drug.
2. Emergency/routine use.
3. Site of action of the drug—local or systemic.
4. Condition of the patient (unconscious, vomiting, diarrhoea).
5. Age of the patient.
6. Effect of gastric pH, digestive enzymes and first-pass metabolism.
7. Patient's/doctor's choice (sometimes).

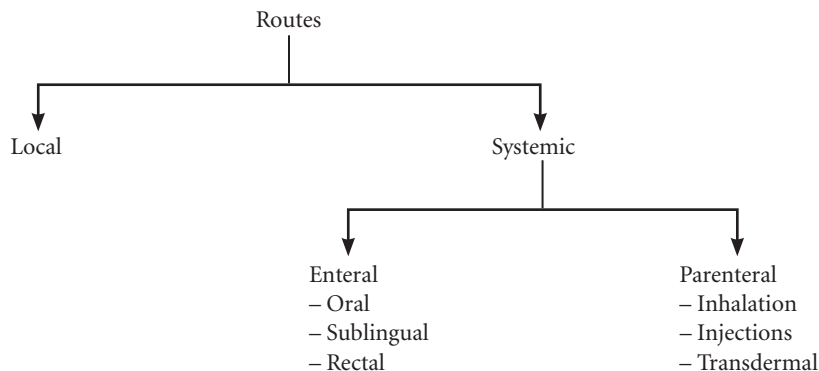

Local Routes

It is the simplest mode of administration of a drug at the site where the desired action is required. Systemic side effects are minimal.

1. **Topical:** Drug is applied to the skin or mucous membrane at various sites for local action.
 - a. **Oral cavity:** As a suspension, e.g. nystatin; as a troche, e.g. clotrimazole (for oral candidiasis); as a cream, e.g. acyclovir (for herpes labialis); as ointment and jelly, e.g. 5% lignocaine hydrochloride (for topical anaesthesia); as a spray, e.g. 10% lignocaine hydrochloride (for topical anaesthesia).
 - b. **GI tract:** As tablet that is not absorbed, e.g. neomycin (for sterilization of gut before surgery).
 - c. **Rectum and anal canal:**
 - i. *As an enema* (administration of drug into the rectum in liquid form):
 - Evacuant enema (for evacuation of bowel): For example, soap water enema—soap acts as a lubricant and water stimulates the rectum.
 - Retention enema: For example, methylprednisolone in ulcerative colitis.
 - ii. *As a suppository* (administration of the drug in a solid form into the rectum), e.g. bisacodyl— for evacuation of bowels.
 - d. **Eye, ear and nose:** As drops, ointments and sprays (for infection, allergic conditions, etc.), e.g. gentamicin eye/ear drops.
 - e. **Bronchi:** As inhalation, e.g. salbutamol, ipratropium bromide, etc. (for bronchial asthma and chronic obstructive pulmonary disease).
 - f. **Skin:** As ointment, cream, lotion or powder, e.g. clotrimazole (antifungal) for cutaneous candidiasis.
2. **Intra-arterial route:** This route is rarely employed. It is mainly used during diagnostic studies such as coronary angiography and for the administration of some anticancer drugs, e.g. for treatment of malignancy involving limbs.
3. **Administration of the drug into some deep tissues** by injection, e.g. administration of triamcinolone directly into the joint space in rheumatoid arthritis.

■ Systemic Routes

Drugs administered by this route enter blood and produce systemic effects.

■ Enteral Routes

It includes oral, sublingual and rectal routes.

● Oral Route

It is the most common and acceptable route for drug administration. Dosage forms are tablet, capsule, syrup, mixture, etc., e.g., paracetamol tablet for fever, omeprazole capsule for peptic ulcer are given orally.

Advantages

- Safer.
- Cheaper.
- Painless.
- Convenient for repeated and prolonged use.
- Can be self-administered.

Disadvantages

- Not suitable for emergency as onset of action of orally administered drugs is slow.

- It is not suitable for/in:
 - Unpalatable and highly irritant drugs.
 - Unabsorbable drugs (e.g. aminoglycosides).
 - Drugs that are destroyed by digestive juices (e.g. insulin).
 - Drugs with extensive first-pass metabolism (e.g. lignocaine).
 - Unconscious patients.
 - Uncooperative and unreliable patients.
 - Patients with severe vomiting and diarrhoea.

Sublingual Route

The preparation is kept under the tongue. The drug is absorbed through the buccal mucous membrane and enters the systemic circulation directly, e.g. nitroglycerin for acute anginal attack and buprenorphine for myocardial infarction.

Advantages

- Quick onset of action.
- Action can be terminated by spitting out the tablet.
- Bypasses first-pass metabolism.
- Self-administration is possible.

Disadvantages

- It is not suitable for:
 - Irritant and lipid-insoluble drugs.
 - Drugs with bad smell and taste.

Rectal Route

Drugs can be given in the form of solid or liquid.

1. **Suppository:** It can be used for local (topical) effect (see p. 4) as well as systemic effect, e.g. indomethacin for rheumatoid arthritis.
2. **Enema:** *Retention enema* can be used for local effect (see p. 4) as well as systemic effect. The drug is absorbed through rectal mucous membrane and produces systemic effect, e.g. diazepam for status epilepticus in children.

Parenteral Routes

Routes of administration other than enteral route are called parenteral routes.

Advantages

- Onset of action of drugs is faster; hence it is suitable for emergency.
- Useful in:
 - Unconscious patient.
 - Uncooperative and unreliable patients.
 - Patients with vomiting and diarrhoea.
- It is suitable for:
 - Irritant drugs.
 - Drugs with high first-pass metabolism.

- Drugs not absorbed orally.
- Drugs destroyed by digestive juices.

Disadvantages

- Require aseptic conditions.
- Preparations should be sterile and is expensive.
- Requires invasive techniques that are painful.
- Cannot be usually self-administered.
- Can cause local tissue injury to nerves, vessels, etc.

► Inhalation

Volatile liquids and gases are given by inhalation for systemic effects, e.g. general anaesthetics.

Advantages

- Quick onset of action.
- Dose required is very less, so systemic toxicity is minimized.
- Amount of drug administered can be regulated.

Disadvantages

- Local irritation may cause increased respiratory secretions and bronchospasm.

► Injections (Fig. 1.1)

Intradermal route: The drug is injected into the layers of the skin, e.g. Bacillus Calmette–Guérin (BCG) vaccination and drug sensitivity tests. It is painful and only a small amount of the drug can be administered.

Subcutaneous (s.c.) route: The drug is injected into the subcutaneous tissues of the thigh, abdomen and arm, e.g. adrenaline, insulin, etc.

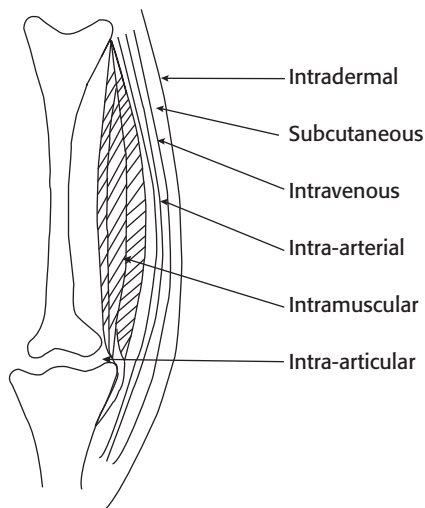

Fig. 1.1 Injectable routes of drug administration.

Advantages

- Self-administration is possible (e.g. insulin).
- Depot preparations can be inserted into the subcutaneous tissue, e.g. norplant for contraception.

Disadvantages

- It is suitable only for nonirritant drugs.
- Drug absorption is slow; hence it is not suitable for emergency.

Intramuscular (i.m.) route: Drugs are injected into large muscles such as deltoid, gluteus maximus and vastus lateralis, e.g. paracetamol, diclofenac, etc. A volume of 5–10 mL can be given at a time.

Advantages

- Absorption is more rapid as compared to oral route.
- Mild irritants, depot injections, soluble substances and suspensions can be given by this route.

Disadvantages

- Aseptic conditions are needed.
- Intramuscular injections are painful and may cause abscess.
- Self-administration is not possible.
- There may be injury to the nerves.

Intravenous (i.v.) route: Drugs are injected directly into the blood stream through a vein. Drugs are administered as:

1. **Bolus:** Single, relatively large dose of a drug injected rapidly or slowly as a single unit into a vein. For example, i.v. ranitidine in bleeding peptic ulcer.
2. **Slow intravenous injection:** For example, i.v. morphine in myocardial infarction.
3. **Intravenous infusion:** For example, dopamine infusion in cardiogenic shock; mannitol infusion in cerebral oedema; fluids infused intravenously in dehydration.

Advantages

- Bioavailability is 100%.
- Quick onset of action; therefore, it is the route of choice in emergency, e.g. intravenous diazepam to control convulsions in status epilepticus.
- Large volume of fluid can be administered, e.g. intravenous fluids in patients with severe dehydration.
- Highly irritant drugs, e.g. anticancer drugs can be given because they get diluted in blood.
- Hypertonic solution can be infused by intravenous route, e.g. 20% mannitol in cerebral oedema.
- By i.v. infusion, a constant plasma level of the drug can be maintained, e.g. dopamine infusion in cardiogenic shock.

Disadvantages

- Once the drug is injected, its action cannot be halted.
- Local irritation may cause phlebitis.
- Self-medication is not possible.
- Strict aseptic conditions are needed.
- Extravasation of some drugs can cause injury, necrosis and sloughing of tissues.
- Depot preparations cannot be given by i.v. route.

Precautions

- Drug should usually be injected slowly.
- Before injecting, make sure that the tip of the needle is in the vein.

Intrathecal route: Drug is injected into the subarachnoid space (spinal anaesthetics, e.g. lignocaine; antibiotics, e.g. amphotericin B, etc.).

Intra-articular route: Drug is injected directly into the joint space, e.g. hydrocortisone injection for rheumatoid arthritis. Strict aseptic precautions should be taken. Repeated administration may cause damage to the articular cartilage.

Transdermal route: The drug is administered in the form of a patch or ointment that delivers the drug into the circulation for systemic effect (Fig. 1.2).

For example, scopolamine patch for sialorrhoea and motion sickness, nitroglycerin patch/ointment for angina, oestrogen patch for hormone replacement therapy (HRT).

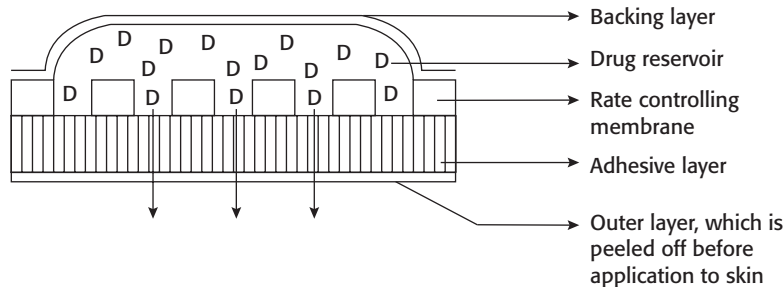

Fig. 1.2 Transdermal drug-delivery system.

Advantages

- Self-administration is possible.
- Patient compliance is better.
- Duration of action is prolonged.
- Systemic side effects are reduced.
- Provides a constant plasma concentration of the drug.

Disadvantages

- Expensive.
- Local irritation may cause dermatitis and itching.
- Patch may fall-off unnoticed.

■ Special Drug-Delivery Systems

1. **Ocusert:** Example, pilocarpine ocusert is kept beneath the lower eyelid in glaucoma. It releases the drug slowly for a week following a single application.
2. **Intraoral lignocaine patch:** Patch containing lignocaine is used to anaesthetize the oral mucosa.
3. **Jet injection:** Small amount of local anaesthetic can be administered into the submucosa without the use of a needle to produce surface anaesthesia.
4. **Liposomes:** They are minute vesicles made of phospholipids into which the drug is incorporated. They help in targeted delivery of drugs, e.g. liposomal formulations of amphotericin B for fungal infections.
5. **Monoclonal antibodies:** They are immunoglobulins, produced by cell culture, selected to react with a specific antigen. They are useful for targeted delivery of drugs, e.g. delivery of anticancer drugs using monoclonal antibodies.

Key Points for Dentists

- Read the label of the drug carefully before administering a drug to the patient.
- Strict aseptic precautions should be taken while giving injections.
- Care should be taken to avoid needle-stick injuries, which may transmit infections, e.g. human immunodeficiency virus (HIV), hepatitis B, hepatitis C, etc.

PHARMACOKINETICS

Pharmacokinetics is derived from two words: *Pharmacon* meaning drug and *kinesis* meaning movement. In short, it is 'what the body does to the drug'. It includes absorption (A), distribution (D), metabolism (M) and excretion (E) of a drug. All these processes involve movement of the drug molecule through various biological membranes.

All biological membranes are made up of lipid bilayer. Drugs cross various biological membranes by the following mechanisms:

1. **Passive diffusion:** It is a bidirectional process. The drug molecules move from a region of higher concentration to lower concentration until equilibrium is attained. The rate of diffusion is directly proportional to the concentration gradient across the membrane. Lipid-soluble drugs are transported across the membrane by passive diffusion. It does not require energy.
2. **Filtration:** Filtration depends on the molecular size and weight of the drug. If the drug molecules are smaller than the pores, they are filtered easily through the membrane.
3. **Specialized transport:**
 - a. **Active transport:** The drug molecules move from a region of lower to higher concentration against the concentration gradient. It requires energy, e.g. transport of sympathomimetic amines into neural tissue, transport of choline into cholinergic neurons and absorption of levodopa from the intestine.
 - b. **Facilitated diffusion:** This is a type of carrier-mediated transport and does not require energy. The drug attaches to a carrier in the membrane, which facilitates its diffusion across the membrane. The transport of molecules is from the region of higher to lower concentration, e.g. transport of glucose across muscle cell membrane by a transporter GLUT4.

■ Drug Absorption

The movement of a drug from the site of administration into the blood stream is known as absorption.

■ Factors Influencing Drug Absorption

1. **Physicochemical properties of the drug:**
 - a. **Physical state:** Liquid form of the drug is better absorbed than solid formulations.
 - b. **Lipid-soluble and unionized form** of the drug is better absorbed than the water-soluble and ionized form.
 - c. **Particle size:** Drugs with smaller particle size are absorbed better than larger ones, e.g. microfine aspirin, digoxin, griseofulvin, etc. are well absorbed from the gut and produce better effects. Some of the anthelmintics have larger particle size. They are poorly absorbed through gastrointestinal (GI) tract and hence produce better effect on gut helminths.

- d. **Disintegration time:** It is the time taken for the formulation (tablet or capsule) to break up into small particles and its variation may affect the bioavailability.
 - e. **Dissolution time:** It is the time taken for the particles to go into solution. Shorter the time, better is the absorption.
 - f. **Formulations:** Pharmacologically inert substances like lactose, starch, calcium sulphate, gum, etc. are added to formulations as binding agents. These are not totally inert and may affect the absorption of drugs, e.g. calcium reduces the absorption of tetracyclines.
2. **Route of drug administration:** A drug administered by intravenous route bypasses the process of absorption, as it directly enters the circulation. Some drugs are highly polar compounds, ionize in solution and are not absorbed through GI tract; hence are given parenterally, e.g. gentamicin. Drugs like insulin are administered parenterally because they are degraded in the GI tract on oral administration.
 3. **pH and ionization:** Strongly acidic (heparin) and strongly basic (aminoglycosides) drugs usually remain ionized at all pH; hence they are poorly absorbed (Fig. 1.3).
 4. **Food:** Presence of food in the stomach can affect the absorption of some of the drugs. Food decreases the absorption of rifampicin, levodopa, etc.; hence they should be taken on an empty stomach for better effect. Milk and milk products decrease the absorption of tetracyclines. Fatty meal increases the absorption of griseofulvin.
 5. **Presence of other drugs:** Concurrent administration of two or more drugs may affect their absorption, e.g. ascorbic acid increases the absorption of oral iron. Antacids reduce the absorption of tetracyclines.
 6. **Pharmacogenetic factors:** Genetic factors may influence drug absorption. In pernicious anaemia, vitamin B₁₂ is not absorbed from the gut due to lack of intrinsic factor.
 7. **Area of the absorbing surface:** Normally, drugs are better absorbed in the small intestine because of a larger surface area. Resection of the gut decreases absorption of drugs due to a reduced surface area.
 8. **Gastrointestinal and other diseases:** In gastroenteritis, there is increased peristaltic movement that reduces the drug absorption. In achlorhydria, absorption of iron from the gut is reduced. In congestive cardiac failure (CCF), there is GI mucosal oedema that reduces the absorption of drugs.

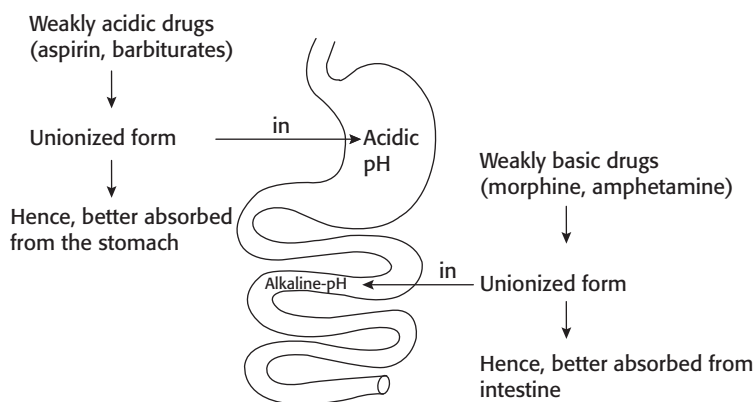

Fig. 1.3 Effect of pH and ionization on drug absorption.

Bioavailability

It is the fraction of a drug that reaches the systemic circulation from a given dose. Intravenous route of drug administration gives 100% bioavailability, as it directly enters the circulation. The term bioavailability is used commonly for drugs given by oral route.

If two formulations of the same drug produce equal bioavailability, they are said to be bioequivalent. If formulations differ in their bioavailability, they are said to be bioinequivalent.

Factors Affecting Bioavailability

The factors that affect drug absorption (physicochemical properties of the drug, route of drug administration, pH and ionization, food, presence of other drugs, pharmacogenetic factors, area of absorbing surface, gastrointestinal and other diseases) also affect bioavailability of a drug. Other factors that affect the bioavailability of a drug are discussed as follows:

1. **First-pass metabolism (First-pass effect, presystemic elimination):** When drugs are administered orally, they have to pass via gut wall → portal vein → liver → systemic circulation. During this passage, certain drugs get metabolized and are removed or inactivated before they reach the systemic circulation. This process is known as first-pass metabolism (Fig. 1.4). The net result is a decreased bioavailability of the drug and diminished therapeutic response. Drugs are lignocaine (liver), isoprenaline (gut wall), etc.

Consequences of high first-pass metabolism:

- i. Drugs that undergo extensive first-pass metabolism are administered parenterally, e.g. lignocaine is administered intravenously in ventricular arrhythmias.
 - ii. Dose of a drug required for oral administration is more than that given by other systemic routes, e.g. nitroglycerin.
2. **Hepatic diseases:** They result in a decrease in drug metabolism; thus increasing the bioavailability of drugs that undergo first-pass metabolism, e.g. propranolol and lignocaine.
 3. **Enterohepatic cycling:** It increases the bioavailability of drugs, e.g. morphine and doxycycline.

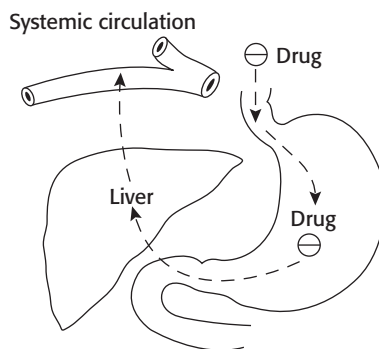
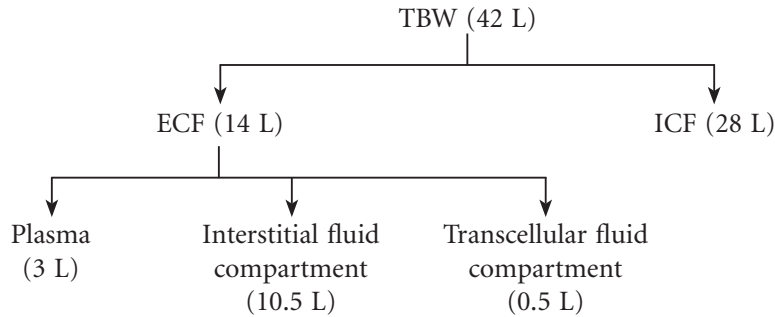

Fig. 1.4 First-pass metabolism.

Drug Distribution

Distribution is defined as the reversible transfer of drugs between body fluid compartments. After absorption, a drug enters the systemic circulation and is distributed in the body fluids. Various body fluid compartments for a 70-kg person can be depicted as:



TBW, total body water; ECF, extracellular fluid; ICF, intracellular fluid.

Apparent Volume of Distribution

Apparent volume of distribution (aV_d) is defined as the hypothetical volume of body fluid into which a drug is uniformly distributed at a concentration equal to that in plasma, assuming the body to be a single compartment.

$$aV_d = \frac{\text{Total amount of drug in the body}}{\text{Concentration of the drug in plasma}}$$

- Drugs with high molecular weight (e.g. heparin) or extensively bound to plasma protein (e.g. warfarin) are largely restricted to the vascular compartment; hence their aV_d is low.
- If aV_d of a drug is about 14–16 L, it indicates that the drug is distributed in the ECF, e.g. gentamicin, streptomycin, etc.
- Small water-soluble molecules like ethanol are distributed in total body water— aV_d is approximately 42 L.
- Drugs that accumulate in tissues have a volume of distribution that exceeds total body water, e.g. chloroquine (13,000 L) and digoxin (500 L). Haemodialysis is not useful for removal of drugs with large aV_d in case of overdose.
- In CCF, V_d of some drugs can increase due to an increase in ECF volume (e.g. alcohol) or decrease because of reduced perfusion of tissues.
- In uremia, the total body water can increase, which increases V_d of small, water-soluble drugs. Toxins that accumulate can displace drugs from plasma-protein-binding sites resulting in increased concentration of free form of drug that can leave the vascular compartment leading to an increase in V_d .
- Fat: Lean body mass ratio—highly lipid-soluble drugs get distributed to the adipose tissue. If the ratio is high, the volume of distribution for such a drug will be higher and fat acts as a reservoir for such drugs.

Redistribution (See p. 154)

Highly lipid-soluble drug, such as thiopentone, on intravenous administration immediately gets distributed to areas of high blood flow such as brain and causes general anaesthesia. Immediately within a few minutes, it diffuses across the blood–brain barrier (BBB) into the blood and then to the less-perfused tissues such as muscle and adipose tissue. This is called redistribution, which results in termination of drug action. Thiopentone has a rapid onset of action and is used for induction of general anaesthesia.

Drug Reservoirs or Tissue Storage

Some drugs are concentrated or accumulated in tissues or some organs of the body, which can lead to toxicity on chronic use. For example, tetracyclines—bones and teeth; thiopentone and DDT—adipose tissue; chloroquine—liver and retina; digoxin—heart, etc.

Blood–Brain Barrier

The capillary boundary that is present between the blood and brain is called blood–brain barrier (BBB). In the brain capillaries, the endothelial cells are joined by tight junctions. Only the lipid-soluble and unionized form of drugs can pass through BBB and reach the brain, e.g. barbiturates, diazepam, volatile anaesthetics, amphetamine, etc. Lipid-insoluble and ionized particles do not cross the BBB, e.g. dopamine and aminoglycosides.

Pathological states like meningitis and encephalitis increase the permeability of the BBB and allow the normally impermeable substances to enter the brain. For example, penicillin G in normal conditions has poor penetration through BBB, but its penetrability increases during meningitis and encephalitis.

Placental Barrier

The lipid membrane between mother and fetus is called placental barrier. Certain drugs administered to the pregnant woman can cross placenta and affect the fetus/newborn, e.g. anaesthetics, morphine, corticosteroids, etc. quaternary ammonium compounds, e.g. d-tubocurarine (d-TC) and substances with high molecular weight like insulin cannot cross the placental barrier.

Plasma Protein Binding

Many drugs bind to plasma proteins like albumin, α_1 acid glycoprotein, etc.

Clinical Importance of Plasma Protein Binding

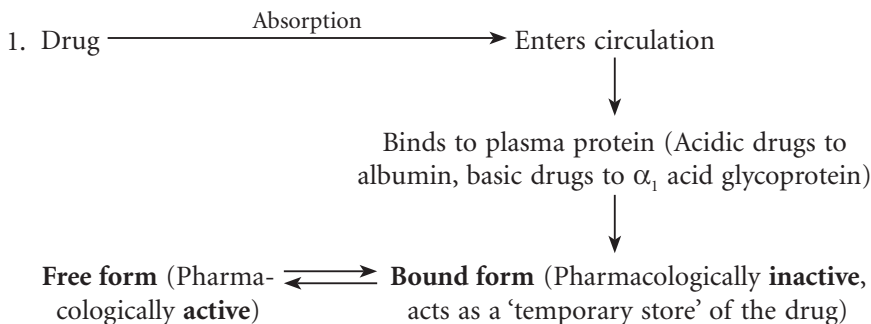

2. Plasma protein binding favours drug **absorption**.
3. Drugs that are highly bound to plasma proteins have a low volume of **distribution**.
4. Plasma protein binding delays the **metabolism** of drugs.
5. Bound form is not available for filtration at the glomeruli; hence **excretion** of highly plasma-protein-bound drugs is delayed.
6. Highly protein-bound drugs have a longer duration of action, e.g. sulphadiazine is less plasma protein bound and has a duration of action of 6 h, whereas sulphadoxine is highly plasma protein bound and has a duration of action of 1 week.

- In case of poisoning, highly plasma-protein-bound drugs are difficult to be removed by haemodialysis.
- In disease states like anaemia, renal failure, chronic liver diseases, etc., plasma albumin levels are low. So there will be an increase in the free form of the drug, which can lead to drug toxicity.
- Plasma protein binding can cause displacement interactions. More than one drug can bind to the same site on plasma protein. The drug with higher affinity will displace the one having lower affinity and may result in a sudden increase in the free concentration of the drug with lower affinity.

■ Biotransformation (Drug Metabolism)

Chemical alteration of the drug in a living organism is called biotransformation. The metabolism of a drug usually converts the lipid-soluble and unionized compounds into water-soluble and ionized compounds. They are not reabsorbed in the renal tubules and are excreted. If the parent drug is highly polar (ionized), it may not get metabolized and is excreted as such.

Sites: Liver is the main site for drug metabolism; other sites are GI tract, kidney, lungs, blood, skin and placenta.

The end result of drug metabolism is inactivation; but sometimes a compound with pharmacological activity may be formed. There are four ways in which the activity of a drug can be altered by its metabolism:

- Active drug to inactive metabolite:** This is the most common type of metabolic transformation.
Phenobarbitone \longrightarrow Hydroxyphenobarbitone
Phenytoin \longrightarrow *p*-Hydroxyphenytoin
- Active drug to active metabolite:**
Codeine \longrightarrow Morphine
Diazepam \longrightarrow Oxazepam
- Inactive drug to active metabolite:**
Levodopa \longrightarrow Dopamine
Prednisone \longrightarrow Prednisolone

■ Prodrug

It is an inactive form of a drug that is converted to an active form after metabolism.

Uses of prodrug (advantages)

- To improve the bioavailability:** Parkinsonism is due to deficiency of dopamine. Dopamine itself cannot be used since it does not cross the BBB. So it is given in the form of a prodrug—levodopa. Levodopa crosses the BBB and is then converted into dopamine.

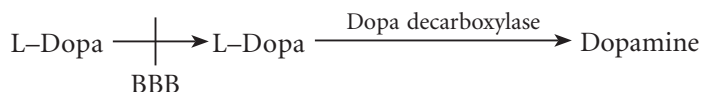

- To prolong the duration of action:** Phenothiazines have a short duration of action, whereas esters of phenothiazine (fluphenazine) have a longer duration of action.
- To improve the taste:** Clindamycin has a bitter taste; so clindamycin palmitate suspension has been developed for pediatric use to improve the taste.
- For site-specific drug delivery:**



Pathways of Drug Metabolism

Drug metabolic reactions are grouped into two phases. They are phase I or nonsynthetic reactions and phase II or synthetic reactions (Fig. 1.5).

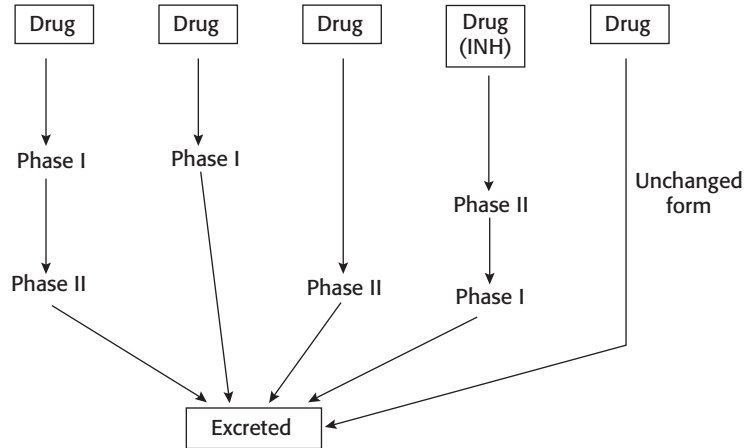

Fig. 1.5 Phases of biotransformation.

Phase I reactions (Table 1.1)

- **Oxidation:** Addition of oxygen and/or removal of hydrogen is called oxidation. It is the most important and common metabolic reaction.
- **Reduction:** Removal of oxygen or addition of hydrogen is known as reduction.
- **Hydrolysis:** Breakdown of the compound by addition of water is called hydrolysis. This is common among esters and amides.
- **Cyclization:** Conversion of a straight-chain compound into ring structure.
- **Decyclization:** Breaking up of the ring structure of the drug.

At the end of phase I, the metabolite may be active or inactive.

Table 1.1 Phase I Reactions

Oxidation	Phenytoin, phenobarbitone, pentobarbitone, propranolol
Reduction	Chloramphenicol, methadone
Hydrolysis	Esters—procaine, succinylcholine Amides—lignocaine, procainamide
Cyclization	Proguanil
Decyclization	Phenobarbitone, phenytoin

Phase II reactions (Table 1.2): Phase II consists of conjugation reactions. If the phase I metabolite is polar, it is excreted in urine or bile. However, many metabolites are lipophilic and undergo subsequent conjugation with an endogenous substrate such as glucuronic acid, sulphuric acid, acetic acid or amino acid. These conjugates are polar, usually water soluble and inactive.

Table 1.2 Phase II Reactions with Examples

Glucuronide conjugation	Morphine, paracetamol
Acetylation	Isoniazid, dapsone
Glycine conjugation	Salicylic acid, nicotinic acid
Sulphate conjugation	Paracetamol, sex steroids
Glutathione conjugation	Paracetamol
Methylation	Adrenaline, dopamine

Not all drugs undergo phase I and phase II reactions in that order. In case of isoniazid (INH), phase II reaction precedes phase I reaction.

Drug-Metabolizing Enzymes

They are broadly divided into two groups—microsomal and nonmicrosomal enzyme systems.

1. **Microsomal enzymes:** They are mainly present in the endoplasmic reticulum of the cells and include cytochrome P 450, glucuronyl transferase, etc. They catalyze most of the phase I reactions and phase II glucuronide conjugating reaction. Microsomal enzymes are inducible. Some human cytochrome P 450 (CYP) genes exhibit polymorphism.
2. **Nonmicrosomal enzymes:** They are found in the cytoplasm, mitochondria of liver cells and in plasma. These enzymes catalyze all phase II reactions except glucuronide conjugation. Some of the oxidative reactions, most of the reduction and hydrolytic reactions are also carried out by nonmicrosomal enzymes. These enzymes usually show genetic polymorphism and are not inducible.

Hofmann elimination: Drugs can be inactivated without the need of enzymes—this is known as Hofmann elimination. Atracurium—a skeletal muscle relaxant undergoes Hofmann elimination.

Factors Affecting Drug Metabolism

1. **Age:** Neonates and elderly metabolize some drugs to a lesser extent than adults. In both the cases, the impairment is due to diminished activity of hepatic microsomal enzymes. Neonates conjugate chloramphenicol more slowly; hence they develop toxicity—gray baby syndrome. Increased incidence of toxicity with propranolol and lignocaine in elderly is due to their decreased hepatic metabolism.
2. **Diet:** Poor nutrition can decrease enzyme function.
3. **Diseases:** Chronic diseases of liver may affect hepatic metabolism of some drugs, e.g. increased duration of action of diazepam in patients with cirrhosis due to impaired metabolism.
4. **Genetic factors (pharmacogenetics):** These factors also influence drug metabolism. The study of genetically determined variation in drug response is called pharmacogenetics. For example:
 - a. **Slow and fast acetylators of isoniazid (INH):** There is an increased incidence of peripheral neuritis with isoniazid in slow acetylators. The fast acetylators require larger dose of the drug to produce therapeutic effect.
 - b. **Succinylcholine apnoea:** Succinylcholine, a neuromuscular blocker, is metabolized by plasma pseudocholinesterase enzyme. The duration of action of succinylcholine is 3–6 min. However, some individuals have atypical pseudocholinesterase that metabolizes the drug very slowly. This results in prolonged apnoea due to paralysis of respiratory muscles, which is dangerous. This is known as succinylcholine apnoea.

- c. **Glucose-6-phosphate dehydrogenase (G6PD) deficiency and haemolytic anaemia:** G6PD activity is important to maintain the integrity of the RBCs. A person with G6PD deficiency may develop haemolysis when exposed to certain drugs like sulphonamides, primaquine, salicylates, dapsone, etc.
5. **Simultaneous administration of drugs:** This can result in increased or decreased metabolism of drugs (see enzyme induction or inhibition).

Enzyme Induction

Repeated administration of certain drugs increases the synthesis of microsomal enzymes. This is known as enzyme induction. The drug is referred to as an enzyme inducer, e.g. rifampicin, phenytoin, barbiturates, carbamazepine, griseofulvin, etc.

Clinical importance of enzyme induction

1. Enzyme induction may accelerate the metabolism of drugs; thus reducing the duration and intensity of drug action, which leads to therapeutic failure, e.g. rifampicin and oral contraceptives. Rifampicin induces the drug-metabolizing enzyme of oral contraceptives; thus enhancing its metabolism and leading to contraceptive failure.
2. Autoinduction may lead to development of drug tolerance, e.g. carbamazepine, enhances its own metabolism.
3. Enzyme induction can lead to drug toxicity, e.g. increased incidence of hepatotoxicity with paracetamol in alcoholics is due to overproduction of toxic metabolite of paracetamol.
4. Prolonged phenytoin therapy may produce osteomalacia due to enhanced metabolism of vitamin D₃.
5. Enzyme inducers can precipitate porphyria due to overproduction of porphobilinogen.
6. Enzyme induction can also be beneficial, e.g. phenobarbitone in neonatal jaundice—phenobarbitone induces glucuronyl transferase enzyme; hence bilirubin is conjugated and jaundice is resolved.

Enzyme Inhibition

Certain drugs inhibit the activity of drug-metabolizing enzymes and are known as enzyme inhibitors, e.g. chloramphenicol, ciprofloxacin, erythromycin, etc. Enzyme inhibition is a rapid process as compared to enzyme induction.

Clinical relevance of enzyme inhibition: Increased incidence of bleeding with warfarin due to concomitant administration of erythromycin or chloramphenicol, etc. These drugs inhibit the drug-metabolizing enzyme of warfarin resulting in increased plasma concentration of warfarin and enhanced anticoagulant effect (bleeding).

■ Drug Excretion

Removal of the drug and its metabolite from the body is known as drug excretion. The main channel of excretion of drugs is the kidney; others include lungs, bile, faeces, sweat, saliva, tears, milk, etc.

1. **Kidney:** The processes involved in the excretion of drugs via kidney are glomerular filtration, passive tubular reabsorption and active tubular secretion. Glomerular filtration and active tubular secretion facilitate drug excretion whereas tubular reabsorption decreases drug excretion.
Rate of renal excretion = (Rate of filtration + Rate of secretion) – Rate of reabsorption

- a. **Glomerular filtration:** Drugs with smaller molecular size are more readily filtered. The extent of filtration is directly proportional to the glomerular filtration rate (GFR) and to the fraction of the unbound drug in plasma.
 - b. **Passive tubular reabsorption:** The main factor affecting the passive reabsorption is the pH of the renal tubular fluid and the degree of ionization. Strongly acidic and strongly basic drugs remain in ionized form at any pH of urine and hence are excreted in urine.
 - i. *Weakly acidic drugs* (e.g. salicylates, barbiturates) in acidic urine remain mainly in 'unionized' form; so they are reabsorbed into the circulation. If the pH of urine is made alkaline by sodium bicarbonate, the weakly acidic drugs get 'ionized' and are excreted easily.
 - ii. Similarly, *weakly basic drugs* (e.g. morphine, amphetamine, etc.) in alkaline urine remain in 'unionized' form, hence are reabsorbed. If the pH of urine is made acidic by vitamin C (ascorbic acid), the basic drugs get 'ionized' and are excreted easily.
 - c. **Active tubular secretion:** It is a carrier-mediated active transport that requires energy. Active secretion is unaffected by changes in the pH of urine and protein binding. Most of the acidic drugs (e.g. penicillin, diuretics, probenecid, sulphonamides, etc.) and basic drugs (e.g. quinine, procaine, morphine, etc.) are secreted by the renal tubules. The carrier system is relatively nonselective and therefore drugs having similar physicochemical properties compete for the same carrier system. For example, probenecid competitively inhibits the tubular secretion of penicillins/cephalosporins, thereby increases the duration of action as well as the plasma half-life and effectiveness of penicillins in the treatment of diseases such as gonococcal infections.
2. **Lungs:** Alcohol and volatile general anaesthetics such as ether, halothane, enflurane and isoflurane are excreted via lungs.
 3. **Faeces:** Drugs that are not completely absorbed from the GI tract are excreted in faeces, e.g. purgatives like senna, cascara, etc.
 4. **Bile:** Some drugs are excreted via bile; but after reaching the intestine they are reabsorbed → liver → bile and the cycle is repeated—such recycling is called enterohepatic circulation and it increases the bioavailability as well as the duration of action of the drug, e.g. morphine and doxycycline.
 5. **Skin:** Metals like arsenic and mercury are excreted through skin.
 6. **Saliva:** Certain drugs like potassium iodide, phenytoin, metronidazole and lithium are excreted in saliva. Salivary estimation of lithium may be used for noninvasive monitoring of lithium therapy.
 7. **Milk:** Drugs taken by lactating women may appear in the milk. It has acidic pH, hence basic drugs like tetracycline, chloramphenicol, morphine, diazepam, etc. remain in ionized form and are excreted through milk; hence they may affect the suckling infant.

■ Pharmacokinetic Parameters

The important pharmacokinetic parameters are bioavailability (see p. 11), volume of distribution (see p. 12), plasma half-life and clearance (CL).

▮ Plasma Half-life ($t/2$)

It is the time required for the plasma concentration of the drug to decrease by 50% of its original value [Fig. 1.6(a)]. Plasma $t/2$ of lignocaine is 1 h and is 4 h for aspirin.

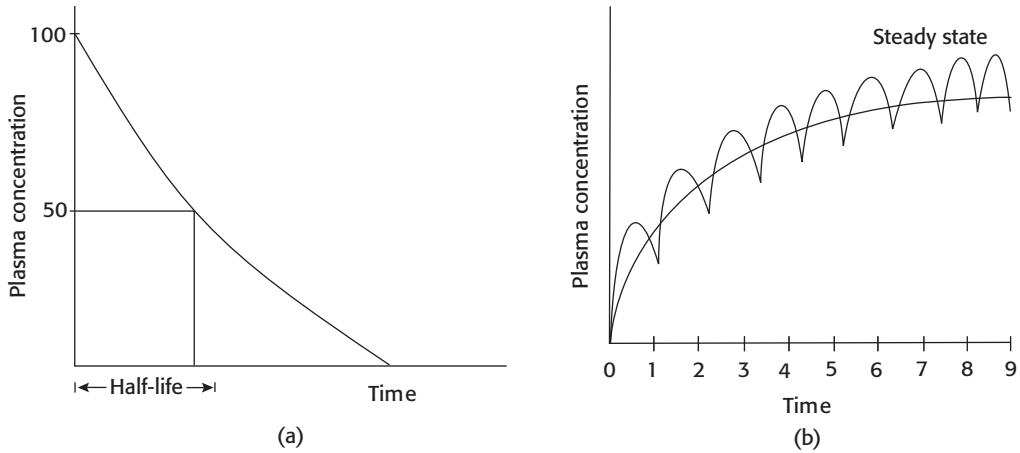

Fig. 1.6 (a) Plasma half-life of a drug after single intravenous injection. (b) Steady state: achieved after approximately four-to-five half-lives during repeated administration at a constant rate.

Clinical Importance of Plasma Half-life

It helps to:

- Determine the duration of drug action.
- Determine the frequency of drug administration.
- Estimate the time required to reach the steady state. At steady state, the amount of drug administered is equal to the amount of drug eliminated in the dose interval. It takes approximately four-to-five half-lives to reach the steady state during repeated administration of the drug. A drug is almost completely eliminated in four-to-five half-lives after single administration.

Clearance

Clearance (CL) of a drug is defined as that fraction of the apparent volume of distribution from which the drug is removed in unit time.

$$\text{Clearance} = \frac{\text{Rate of elimination}}{\text{Plasma concentration of the drug}}$$

1. **First-order kinetics:** A constant *fraction* of the drug in the body is eliminated per unit time.

For example, assume a drug 'A' with a plasma $t/2$ of 1 h following first-order kinetics of elimination having initial plasma concentration of 100 mcg/mL. A constant fraction (e.g. $1/2$) is eliminated per unit time.

$$100 \text{ mcg/mL} \xrightarrow[\frac{1}{2}]{1 \text{ h}} 50 \text{ mcg/mL} \xrightarrow[\frac{1}{2}]{1 \text{ h}} 25 \text{ mcg/mL}$$

The rate of drug elimination is *directly proportional* to its plasma concentration. The $t/2$ of the drugs following first-order kinetics will always remain constant. The drug will be almost completely eliminated in four-to-five plasma half-lives, if administered at a constant rate at each half-life. Most of the drugs follow first-order kinetics.

2. **Zero-order kinetics:** A constant *amount* of a drug in the body is eliminated per unit time. The rate of elimination is *independent* of plasma drug concentration, e.g. ethanol is eliminated from the body at the rate of about 10 mL/h. The $t/2$ of the drug following zero-order kinetics is never constant.

For example, assume a drug 'B' with an initial plasma concentration of 200 mcg/mL and eliminated at the rate of 10 mcg/h. Its elimination will be as follows:

$$200 \text{ mcg/mL} \xrightarrow[10 \text{ mcg}]{1 \text{ h}} 190 \text{ mcg/mL} \xrightarrow[10 \text{ mcg}]{1 \text{ h}} 180 \text{ mcg/mL}$$

Drugs like phenytoin and aspirin



At low doses, follow *first-order* kinetics



As the plasma concentration increases



Elimination processes get saturated



Kinetics changes over to *zero order* (saturation kinetics)

Note: Phenytoin exhibits *saturation kinetics* and its plasma concentration has to be carefully monitored [therapeutic drug monitoring (TDM)] when used in the treatment of epilepsy.

Once the kinetics change to zero order, small increase in dose results in a disproportionate increase in plasma concentration that leads to drug toxicity.

Steady State Concentration

If a constant dose of a drug is given at constant intervals, plasma concentration of the drug increases due to its absorption and falls due to elimination in each dosing interval. Finally, the amount of drug eliminated will equal the amount of drug administered in the dosing interval. The drug is said to have reached steady state or plateau level [see Fig 1.6(b), p. 19]. It is attained after approximately four-to-five half-lives.

Factors Influencing Drug Dosage

Many factors have to be considered when a drug is given to a patient. The time taken to act depends mainly on the route of drug administration. For rapid effect, the drug is usually given intravenously. In general, the time taken to reach a steady state is approximately four-to-five half-lives of the drug during repeated administration at a constant rate.

1. **Loading dose:** Initially, a large dose or series of doses of a drug is given with the aim of rapidly attaining the steady state concentration in the plasma. This is known as loading dose. A loading dose is administered if the time taken to reach steady state is relatively more as compared to the patient's condition, e.g. the half-life of lignocaine is more than 1 h, so it takes more than 4–6 h to reach the target concentration. When a patient has life-threatening ventricular arrhythmias after myocardial infarction, initially a large dose of lignocaine has to be given to achieve desired plasma concentration quickly. Once it is achieved, it is maintained by giving the drug as an intravenous infusion.

2. **Maintenance dose:** The dose of a drug that is repeated at fixed intervals or given as a continuous infusion to maintain steady state concentration is known as maintenance dose. The dose administered is equal to dose eliminated in a dosing interval.

■ Therapeutic Drug Monitoring

Monitoring drug therapy by measuring plasma concentration of a drug is known as *therapeutic drug monitoring (TDM)*.

Indications

1. Drugs with narrow therapeutic index, e.g. lithium, digoxin, phenytoin, aminoglycosides, etc.
2. Drugs showing wide interindividual variations, e.g. tricyclic antidepressants.
3. To ascertain patient compliance.
4. For drugs whose toxicity is increased in the presence of renal failure, e.g. aminoglycosides.
5. To check the bioavailability.
6. In patients who do not respond to therapy without any known reason.

TDM is not required in the following situations

1. When clinical and biochemical parameters are available to assess response:
 - a. Blood pressure measurement for antihypertensives.
 - b. Blood sugar estimation for antidiabetic agents.
 - c. Prothrombin time, activated partial thromboplastin time (aPTT) and International Normalized Ratio (INR) for anticoagulants.
2. Drugs producing tolerance, e.g. opioids.
3. Drugs whose effect persists longer than the drug itself, e.g. omeprazole.
4. If TDM is expensive.

■ Fixed-Dose Combination (FDC; Fixed Dose Ratio Combinations)

It is the combination of two or more drugs in a fixed dose ratio in a single formulation.

Some of the examples of WHO-approved FDCs are:

- Levodopa + carbidopa for parkinsonism.
- Isoniazid + rifampicin + pyrazinamide for tuberculosis.
- Ferrous sulphate + folic acid for anaemia of pregnancy.
- Sulphamethoxazole + trimethoprim for cotrimoxazole.
- Amoxicillin + clavulanic acid in augmentin.
- Oestrogen + progesterone as oral contraceptive.

Advantages and disadvantages of FDC are explained in Table 1.3.

Table 1.3 Advantages and Disadvantages of FDC

Advantages of FDC	Disadvantages of FDC
1. Increased patient compliance	1. Inflexible fixed-dose ratio
2. Synergistic effect	2. Incompatible pharmacokinetics
3. Increased efficacy	3. Increased toxicity due to inappropriate combinations. If adverse effect occurs, it is difficult to identify the component of FDC causing it.
4. Reduced side effects	4. The preparation cannot be used if there is a contraindication for use of one component.
5. Reduced cost	5. Physician and pharmacist's ignorance of the contents
6. Prevents development of microbial resistance	

■ Methods to Prolong the Duration of Drug Action

Prolongation of action of a drug helps:

- To reduce the frequency of drug administration.
- To improve patient compliance.
- To minimize fluctuations in plasma concentration.

Various methods to prolong the duration of drug action are:

1. For orally administered drugs:

- a. **By using sustained release preparations:** These preparations consist of drug particles that have different coatings dissolving at different intervals of time. It prolongs the duration of action of the drug, reduces the frequency of administration and improves patient compliance, e.g. tab. diclofenac has a duration of action of 12 h, whereas diclofenac sustained-release preparation has a duration of action of 24 h.

2. For parenterally administered drugs:

a. By retarding drug absorption

- **By decreasing the vascularity of the absorbing surface:** This is achieved by adding a vasoconstrictor to the drug, e.g. adrenaline with local anaesthetics. When adrenaline is added to a local anaesthetic, the vasoconstriction produced by adrenaline will delay the removal of the local anaesthetic from the site of administration and prolongs the duration of its action. It also reduces the systemic toxicity of the local anaesthetic and minimizes bleeding in the operative field. Felypressin is an alternative to adrenaline. It is an analogue of vasopressin and a powerful vasoconstrictor.

Combined preparation of adrenaline with a local anaesthetic should be avoided in patients with hypertension, CCF, cardiac arrhythmias, ischaemic heart disease and thyrotoxicosis because of its dangerous side effects on the heart (see p. 82).

- **By decreasing the solubility of the drug:** By combining it with a water-insoluble compound. For example,
 - Injection penicillin G has a duration of action of 4–6 h.
 - Injection procaine penicillin G: It has a duration of action of 12–24 h.
 - Injection benzathine penicillin G: It has a duration of action of 3–4 weeks.
 - **By combining the drug with a protein,** e.g. protamine zinc insulin– the complexed insulin is released slowly from the site of administration, thus prolonging its action.
 - **By esterification:** Esters of testosterone, e.g. testosterone propionate and testosterone enanthate are slowly absorbed following intramuscular administration resulting in prolonged action.
 - **Injecting the drug in oily solution,** e.g. depot progestins (depot medroxyprogesterone acetate).
 - **Pellet implantation:** e.g. norplant for contraception.
 - **Transdermal patch** (see p. 8)
- b. **By increasing the plasma protein binding of the drug,** e.g. sulphadiazine is less bound to plasma proteins and has a duration of action of 6 h. Sulphadoxine is highly protein bound and so has a duration of action of 1 week.
 - c. **By inhibiting drug metabolism:** Anticholinesterases (physostigmine and neostigmine) prolong the duration of action of acetylcholine by inhibiting cholinesterases.
 - d. **By delaying renal excretion of the drug,** e.g. penicillin/cephalosporins with probenecid (see p. 313).

PHARMACODYNAMICS

Pharmacodynamics (*Gr. Pharmakon: drug; dynamis: power*): In short, it covers all the aspects relating to 'what the drug does to the body'. It is the study of drugs—their mechanism of action, pharmacological actions and adverse effects.

Types of Drug Action

1. **Stimulation:** Some drugs act by increasing the activity of specialized cells, e.g. adrenaline stimulates the heart resulting in an increase in heart rate and force of contraction.
2. **Depression:** Some drugs act by decreasing the activity of specialized cells, e.g. alcohol, barbiturates, general anaesthetics, etc. depress the central nervous system.
3. **Irritation:** Certain agents on topical application can cause irritation of the skin and adjacent tissues. When an agent on application to the skin relieves deep-seated pain, it is known as counterirritant (e.g. eucalyptus oil, methyl salicylate, etc.). They are useful in sprains, joint pain, myalgia, etc.
4. **Replacement:** When there is a deficiency of endogenous substances, they can be replaced by drugs, e.g. insulin in diabetes mellitus, thyroxine in cretinism and myxedema, etc.
5. **Cytotoxic:** Drugs are selectively toxic for the infecting organism/cancer cells, e.g. antibiotics/anticancer drugs.

Mechanism of Drug Action

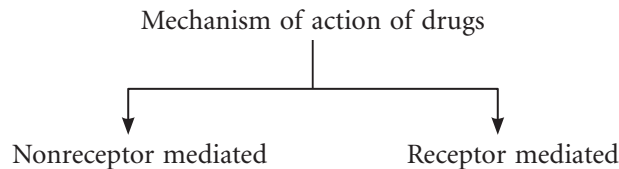

Nonreceptor-mediated Mechanisms

1. **By physical action:**
 - a. **Osmosis:** Some drugs act by exerting an osmotic effect, e.g. 20% mannitol in cerebral oedema and acute congestive glaucoma.
 - b. **Adsorption:** Activated charcoal adsorbs toxins; hence it is used in the treatment of drug poisoning.
 - c. **Demulcent:** Cough syrup produces a soothing effect in pharyngitis by coating the inflamed mucosa.
 - d. **Radioactivity:** Radioactive isotopes emit rays and destroy the tissues, e.g. ^{131}I in hyperthyroidism.
2. **By chemical action:**
 - a. Antacids are weak bases; hence they neutralize acid in the stomach in peptic ulcer.
 - b. Metals like iron, copper, mercury, etc. are eliminated from the body with the help of chelating agents. They trap the metals in their ring structure and form water-soluble complexes, which are rapidly excreted from the body. For example, dimercaprol (BAL) in arsenic poisoning, desferrioxamine in iron poisoning, D-penicillamine in copper poisoning.

3. **Through enzymes:** Some drugs act either by activating or inhibiting the enzyme activity.

a. **Drug action via enzyme inhibition:**

- i. Angiotensin-converting-enzyme inhibitors such as captopril, enalapril, etc. act by inhibiting angiotensin converting enzyme (ACE) and are used in the treatment of hypertension, congestive cardiac failure, etc.
- ii. Xanthine and hypoxanthine are oxidized to uric acid by the enzyme xanthine oxidase, which is inhibited by allopurinol. Allopurinol is used in the treatment of chronic gout to reduce the synthesis of the uric acid.

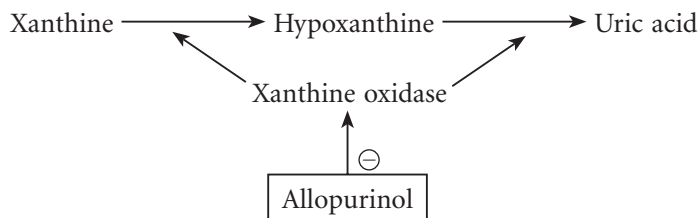

4. **Through ion channels:** Some drugs directly bind to ion channels and alter the flow of ions, e.g. local anaesthetics block sodium channels in neuronal membrane to produce local anaesthesia.
5. **Through antibody production:** Vaccines produce their effect by stimulating the formation of antibodies, e.g. vaccines against tuberculosis (BCG), oral polio vaccine, etc.
6. **Transporters:** Some drugs produce their effect by binding to transporters. Selective serotonin reuptake inhibitors (SSRIs) → bind to 5-HT transporter → block 5-HT reuptake into neurons → antidepressant effect.
7. **Others:** Anticancer drugs like cyclophosphamide produce their effect by binding to nucleic acids.

Receptor-mediated Mechanisms

Receptors are macromolecules present either on the cell surface, cytoplasm or in the nucleus with which the drug binds and interacts to produce cellular changes.

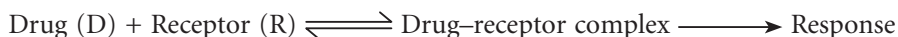

For example, adrenergic receptors (α and β), cholinergic receptors (muscarinic and nicotinic), opioid receptors, etc.

Affinity: The ability of the drug to get bound to the receptor is known as affinity.

Intrinsic activity: The ability of the drug to produce pharmacological action after combining with the receptor is known as *intrinsic activity* of the drug.

Agonist: A drug that is capable of producing pharmacological action after binding to the receptor is called an *agonist*.

Agonist has high affinity + high intrinsic activity (e.g. morphine and adrenaline).

Competitive antagonist: A drug that binds to receptors but is not capable of producing pharmacological action is called an *antagonist*.

Antagonist has high affinity without intrinsic activity (e.g. naloxone and atropine). It produces receptor blockade.

Partial agonist: A drug that binds to the receptor but produces an effect less than that of an agonist is called partial agonist.

Partial agonist has affinity + less intrinsic activity (e.g. pindolol and buprenorphine).

Inverse agonist: It has full affinity towards the receptor but produces effect opposite to that of an agonist. For example, benzodiazepines produce antianxiety and anticonvulsant effects by interacting with its receptors; but β -carbolines act as inverse agonist at benzodiazepine receptor, and produce anxiety and convulsions.

Inverse agonist has affinity and intrinsic activity between 0 and -1 (e.g. β -carbolines).

Receptor Families (Table 1.4)

1. Ligand-gated ion channels (ionotropic receptors).
2. G-protein-coupled receptors (metabotropic receptors).
3. Enzymatic receptors.
4. Receptor regulating gene expression (transcription factors) or the nuclear receptor.

Table 1.4 Characteristics of Various Receptor Families

	Ligand-gated ion Channels	G-protein-coupled Receptors	Enzymatic Receptors	Nuclear Receptors
Location	Membrane	Membrane	Membrane	Intracellular
Effector	Ion channel	Channel or enzyme	Enzyme	Gene transcription
Coupling	Direct	G-proteins (Gs, Gi, Gq, etc.)	Direct	Via DNA
Examples	Nicotinic, GABA _A receptors	Muscarinic, adrenergic receptors	Insulin, growth factor, cytokine receptors	Steroid, thyroid hormone receptors
Time required for response	Milliseconds	Seconds	Hours	Hours

Ligand-gated Ion Channels (Ionotropic Receptors)

Examples are nicotinic (N_M) acetylcholine receptors of neuromuscular junction, GABA and glutamate receptors in the central nervous system (CNS).

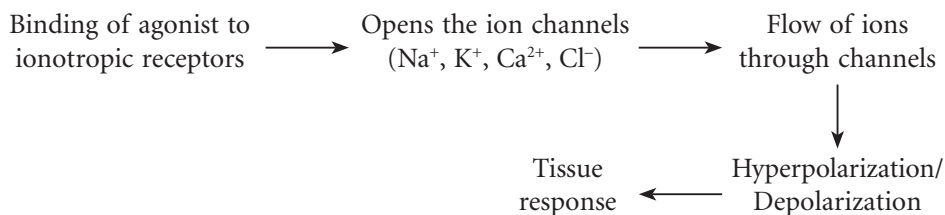

G-Protein-Coupled Receptors (Metabotropic Receptors)

They are coupled to intracellular effectors through G-proteins. G-proteins are membrane proteins and have three subunits (α , β , γ) with GDP bound to α -subunit.

Effector pathways and second messengers: G-protein-coupled receptors control cell function via adenylyl cyclase, phospholipase C and ion channels.

The agonist that binds to the receptor is the first messenger that results in the generation or recruitment of molecules (second messengers) that initiate the signalling mechanism in a cell. Examples of second messengers are cAMP (generated by adenylyl cyclase), cGMP (generated by guanylyl cyclase), Ca^{2+} , inositol triphosphate–diacylglycerol (IP_3 –DAG) (generated by phospholipase C), nitric oxide, etc.

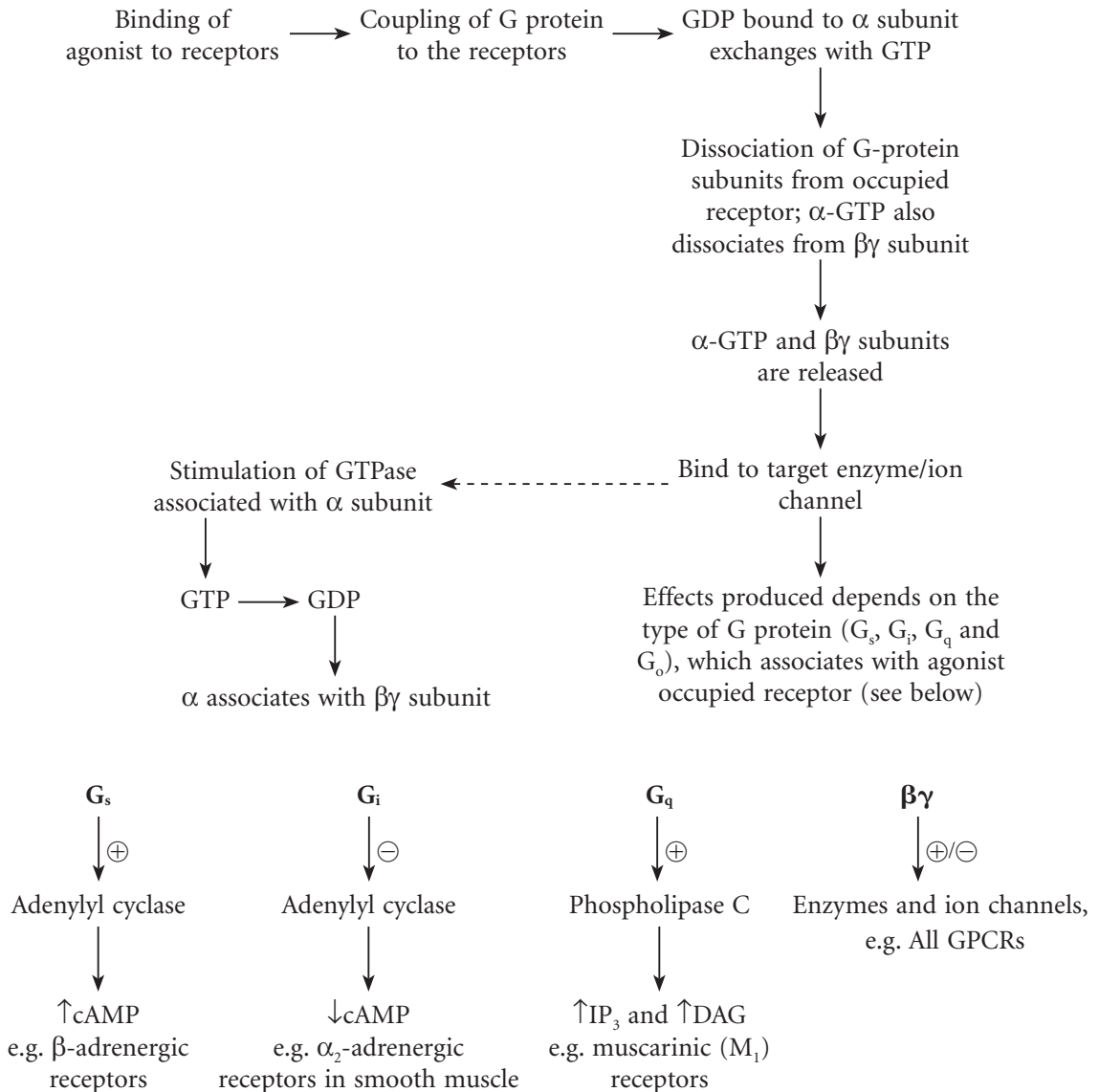

Enzyme-linked Receptors

For example, receptors for insulin (receptor tyrosine kinase) and growth factors (epidermal growth factor, platelet derived growth factor, etc.).

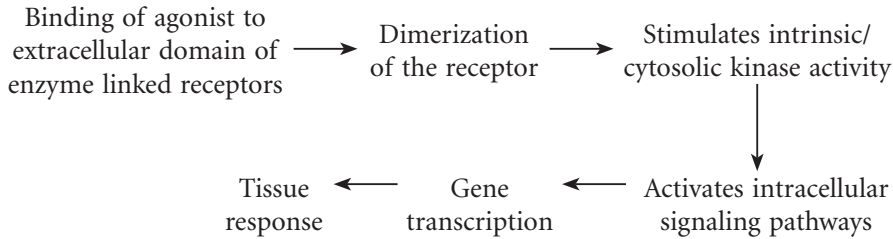

Nuclear Receptors

Examples are receptors for sex steroids and glucocorticoids.

See p. 268 in Ch. 10

Regulation of Receptors

Receptors can be regulated by various mechanisms resulting in either their up-regulation or down-regulation (Table 1.5).

Table 1.5 Regulation of Receptors

Receptor Down-regulation	Receptor Up-regulation
<p>Prolonged use of agonists ↓ ↓↓ Receptor number and sensitivity ↓ ↓↓ Drug effect</p> <p>For example, chronic use of salbutamol down-regulates the β_2-adrenoceptors, which may be responsible for decreased effect of salbutamol in asthmatics.</p>	<p>Prolonged use of antagonists ↓ ↑↑ Receptor number and sensitivity On sudden stoppage of antagonist ↓ ↑↑ Response to agonist</p> <p>For example, when propranolol is stopped after prolonged use, some patients experience withdrawal symptoms, such as nervousness, anxiety, palpitation, tachycardia, rise in BP, increased incidence of angina or even MI may be precipitated. This is due to up-regulation or supersensitivity of β-adrenoceptors to catecholamines.</p> <p>Therefore, propranolol should not be discontinued abruptly.</p>

Dose–Response Relationship

The pharmacological effect of a drug depends on its concentration at the site of action, which, in turn, is determined by the dose of the drug administered. Such a relationship is called ‘dose–response relationship’.

Graded dose response [Fig. 1.7(a) and (b)]: This curve, when plotted on a graph, takes the form of a rectangular hyperbola; if the dose is plotted on a logarithmic scale, a sigmoid shaped log dose–response curve is obtained.

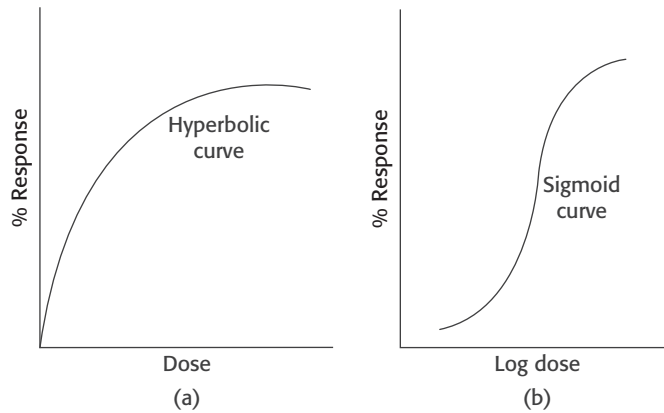

Fig. 1.7 (a) Dose–response curve; (b) Log dose–response curve.

Therapeutic Index

Therapeutic index (TI) is an index of drug safety.

$$TI = \frac{\text{Median lethal dose (LD}_{50}\text{) of the drug}}{\text{Median effective dose (ED}_{50}\text{) of the drug}}$$

It is the ratio of median lethal dose to the median effective dose (Fig. 1.8).

- LD₅₀:** It is the dose of a drug that is lethal for 50% of the population.
- ED₅₀:** It is the dose of the drug that produces desired effect in 50% of the population.

Wider the value of therapeutic index, safer is the drug. For example, penicillin has a high therapeutic index; digitalis, lithium and phenytoin have narrow therapeutic index.

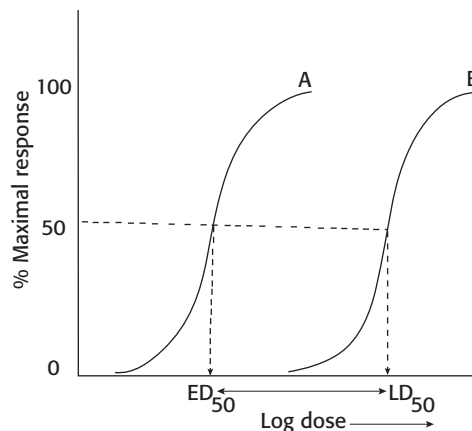

Fig. 1.8 Dose–response curves of therapeutic effect (A) and adverse effect (B). Distance between ED₅₀ and LD₅₀ indicates safety margin.

Drug Potency

The amount of a drug required to produce a desired response is called the potency of the drug. The lower the dose required for a given response, the more potent is the drug. For example, the analgesic dose of morphine is 10 mg and that of pethidine is 100 mg. Therefore, morphine is ten times more potent than pethidine as an analgesic. Dose–response curve (DRC) of two drugs—drug A (morphine) and drug B (pethidine) as analgesic— are compared (Fig. 1.9).

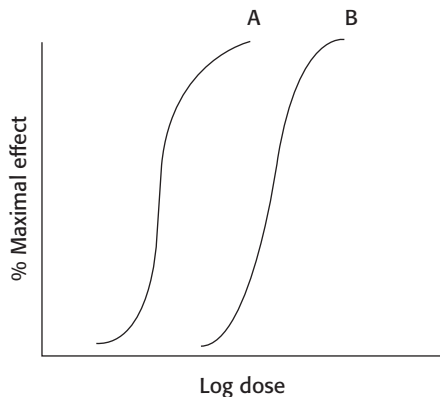

Fig. 1.9 Relative potency of two drugs.

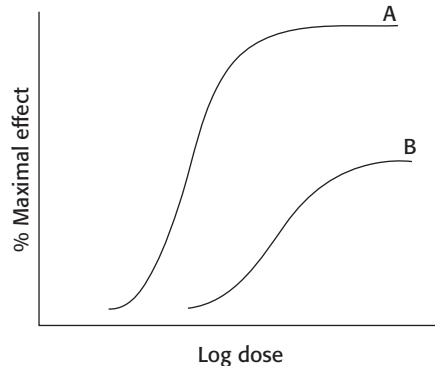

Fig. 1.10 Relative efficacy of two drugs.

Drug Efficacy

It is the maximum effect of a drug. For example, morphine is more efficacious than aspirin as an analgesic (Fig. 1.10).

Therapeutic Window

It is the range of concentration of the drug that produces desired response with minimal toxicity.

Combined Effects of Drugs

A combination of two or more drugs can result in an increase or a decrease in response.

Increased response:

1. **Additive effect:** The combined effect of two or more drugs is equal to the sum of their individual effect.

$$\text{Effect of drugs A + B} = \text{Effect of drug A} + \text{Effect of drug B}$$

For example, ibuprofen and paracetamol as analgesic.

2. **Potentiation (supra-additive):** The enhancement of action of one drug by another drug that is inactive is called *potentiation*.

$$\text{Effect of drugs A + B} > \text{Effect of drug A} + \text{Effect of drug B}$$

For example, levodopa + carbidopa; acetylcholine + physostigmine.

Carbidopa and physostigmine inhibit the breakdown of levodopa and acetylcholine, respectively; thus enhancing their effects.

3. **Synergism:** When two or more drugs are administered simultaneously, their combined effect is greater than that elicited by either drug alone.

For example, sulphamethoxazole + trimethoprim (see pp. 304).

Decreased response (drug antagonism):

In antagonism, the effect of one drug is decreased or abolished in the presence of another drug.

1. **Physical antagonism:** The opposing action of the two drugs is due to their physical property, e.g. activated charcoal adsorbs toxic substances in poisoning.
2. **Chemical antagonism:** The opposing action of two drugs is due to their chemical property, e.g. antacids are weak bases that neutralize gastric acid; chelating agents complex metals and are useful in heavy metal poisoning.
3. **Physiological (functional) antagonism:** Here, two drugs act at different receptors or by different mechanisms on the same physiological system and produce opposite effects. For example, insulin and glucagon on blood sugar, adrenaline and histamine on bronchial smooth muscle—histamine produces bronchoconstriction (via histamine receptors), whereas adrenaline produces bronchodilatation by acting through adrenergic (β_2) receptors—hence adrenaline helps to reverse bronchospasm in anaphylactic shock.
4. **Receptor antagonism:** The antagonist binds to the same receptor as the agonist and inhibits its effects. It can be competitive or noncompetitive.
 - a. **Competitive antagonism (equilibrium type):** In competitive antagonism, both agonist and the antagonist bind reversibly to the same site on the receptor. This type of antagonism can be overcome (reversible) by increasing the concentration of agonist. The log dose–response curve of the agonist shows a rightward parallel shift in the presence of competitive antagonist (Fig. 1.11).

For example,

Acetylcholine	→	Muscarinic receptors	←	Atropine
Morphine	→	Opioid receptors	←	Naloxone
(Agonists)				(Antagonists)

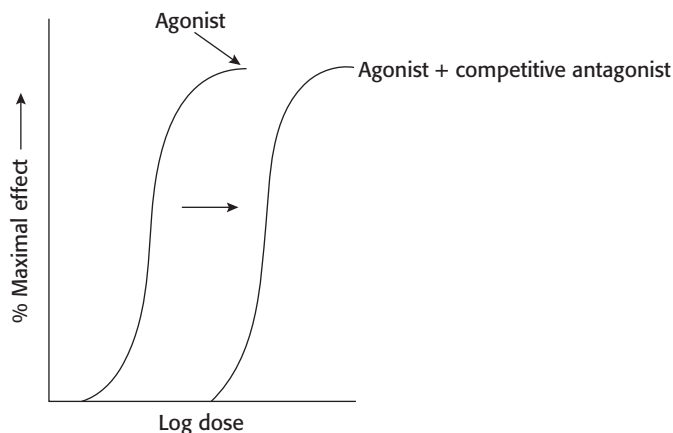

Fig. 1.11 Competitive antagonism.

- b. **Noncompetitive antagonism:** The antagonist binds to a different site on the receptor and prevents the agonist from interacting with the receptor. In this type, the antagonistic effect cannot be overcome by increasing the concentration of the agonist. There is a flattening of the dose–response curve (DRC) in noncompetitive antagonism, e.g. diazepam and bicuculline (Fig. 1.12).

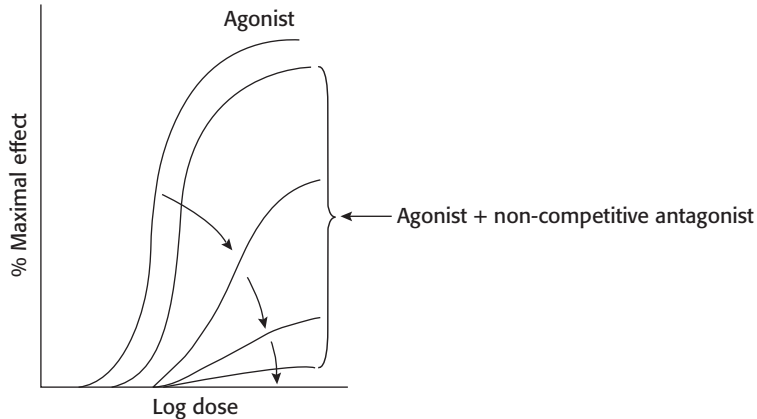

Fig. 1.12 Noncompetitive antagonism.

FACTORS MODIFYING DRUG ACTION

There are a number of factors that can influence drug response. Individuals may often show quantitative variations in drug response, but rarely show qualitative variations. The important factors are described in Table 1.6.

Table 1.6 Factors Influencing Drug Response

Drug Factors	Patient Factors
<ul style="list-style-type: none"> • Route of administration • Presence of other drugs • Cumulation 	<ul style="list-style-type: none"> • Age • Body weight • Sex • Environment • Genetic factor • Emotional factor • Pathological state • Tolerance • Drug dependence

Drug Factors

1. **Route of administration:** When a drug is administered by different routes, it commonly exhibits quantitative variations; but sometimes it may also result in qualitative variations in response.
 - a. **Quantitative variation:** Oral dose of the drugs are usually larger than intravenous dose (since i.v. route produces 100% bioavailability), e.g. intravenous dose of morphine is 5–10 mg, whereas oral dose is 30–60 mg for analgesic effect.

- b. **Qualitative variation:** The drug may produce an entirely different response when administered by different routes. For example, magnesium sulphate orally produces purgative effect; parenterally it causes CNS depression and locally reduces oedema in the inflamed area.
2. **Presence of other drugs:** See addition, potentiation, synergism and antagonism.
3. **Cumulation:** When the elimination of a drug is slower than the rate of administration, the drug may accumulate in the body causing cumulative toxicity, e.g. digoxin, emetine, chloroquine, etc.

■ Patient Factors

1. **Age:** In neonates, the metabolizing function of the liver and excretory function of the kidney is not fully developed, e.g. chloramphenicol can cause grey baby syndrome when given to neonates as the metabolizing enzymes are not fully developed. In adults, penicillin G is given sixth hourly; but in infant, it is administered less frequently as the excretory function is not completely developed. In the elderly, the renal and hepatic functions progressively decline. The incidence of adverse effect of drugs is also relatively more and so drug doses have to be reduced accordingly, e.g. dose of aminoglycosides in elderly is less than normal adult dose. The dose of a drug for a child can be calculated as follows:

$$\text{Young's formula: Child dose} = \frac{\text{Age}}{\text{Age} + 12} \times \text{Adult dose}$$

$$\text{Dilling's formula: Child dose} = \frac{\text{Age}}{20} \times \text{Adult dose}$$

2. **Body weight and body surface:** An average dose of a drug is calculated in terms of body weight (mg/kg).

$$\text{Dose for an individual} = \frac{\text{Body weight (kg)}}{70} \times \text{Average adult dose}$$

In obese, lean and in a patient with dehydration or oedema, dose calculation on the basis of body weight is not very appropriate. A more accurate method for calculating a dose is on the basis of the body surface area (BSA) of the patient. Nomograms are available to calculate BSA from height and weight of the patient. Since it is inconvenient to calculate BSA, routinely dose is calculated on body weight basis. Dose of anticancer drugs and a few other drugs are calculated on the basis of BSA.

3. **Sex:** Drugs like β -blockers, diuretics and clonidine can cause decreased libido in males.
4. **Diet and environmental factors:** Milk reduces absorption of tetracyclines; fatty meal increases the absorption of griseofulvin (antifungal agent). Certain environmental pollutants such as DDT, cigarette smoke, insecticides, etc. induce hepatic microsomal enzymes and increase the metabolism of drugs such as oral contraceptives, theophylline, etc. So the dose of these drugs administered may be inadequate in smokers.
5. **Genetic factor:** See p. 16 under metabolism.
6. **Psychological factor:** Personality of the doctor as well as the patient can affect response to a drug. Some patients even respond to inert dosage forms (placebo) in conditions like pain, bronchial asthma, anxiety, etc.

Placebo effect: ‘Placebo’ is a Latin term that means ‘I will please’. It is a dummy medicine having no pharmacological activity. The effect produced by placebo is called placebo effect. Sugar tablets and distilled water injection are used as placebos.

Uses

- Placebos are used for the relief of subjective symptoms like anxiety, headache, tremors, pain, insomnia, etc.
- Placebos are used in clinical trials in order to minimize bias.

Factors affecting placebo effect are:

- *Patient factor:* Patients with neurotic symptoms often respond to placebos.
- *Drug factor:* The placebo response can be affected by the physical presentation or route of administration of the drug. For example, colourful tablets such as red, blue, green and also injectable preparations give better placebo effect.
- *Doctor factor:* Personality of the doctor, motivation, way of instruction, doctor–patient relationship, etc. are important factors that also affect the response to placebo.

7. Pathological states:

- a. **GI disorders:** Achlorhydria reduces the absorption of acidic drugs in the stomach by causing its ionization. In malabsorption syndrome, the absorption of some drugs is reduced.
- b. **Liver disease:** In chronic liver diseases, the metabolism of drugs is greatly reduced. This will increase bioavailability of drugs having high first-pass metabolism, e.g. propranolol.
- c. **Renal failure:** Clearance of drugs that are excreted through kidney is impaired. For example, the incidence of nephrotoxicity and ototoxicity is more with aminoglycosides in the presence of renal failure.

8. **Tolerance:** Repeated administration of certain drugs can result in a decrease in their pharmacological effect. Hence, higher doses of such drugs are needed to produce a given response, e.g. ephedrine, organic nitrates, opioids, etc. Tolerance develops to nasal decongestant effect of ephedrine on repeated use. Patients on organic nitrates for angina develop tolerance on long-term therapy. Tolerance is commonly seen with drugs like morphine, alcohol, amphetamine, etc.

a. **Types of tolerance**

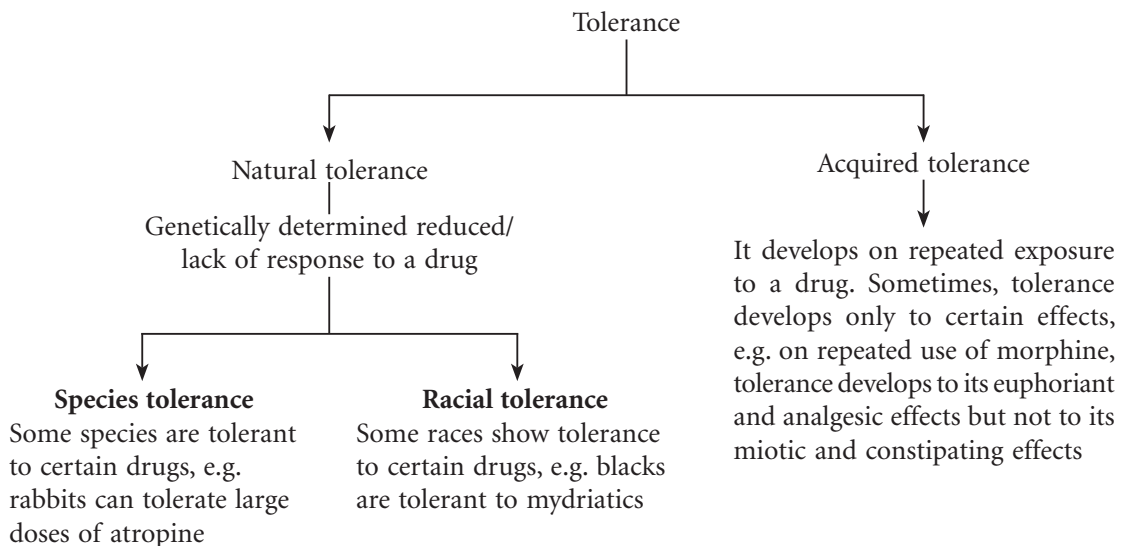

- b. **Mechanism of development of tolerance:** It could be pharmacokinetic or pharmacodynamic tolerance.
- Pharmacokinetic tolerance (Dispositional tolerance):** Reduced concentration of the drug at the site of action may be due to decreased absorption, increased metabolism and excretion, e.g. barbiturates, carbamazepine.
 - Pharmacodynamic tolerance (Functional tolerance):** The drug effect is reduced, which may be due to a decrease in the number of receptors, decrease in the activity of receptors and decreased neurotransmitter. Repeated use of opioids, barbiturates, etc. results in the development of tolerance due to a decrease in the number of receptors (down-regulation).
 - Cross-tolerance:** The phenomenon of tolerance exhibited by closely related drugs is called cross-tolerance. For example, it occurs among nitrates, opioids, and between ether and alcohol.
 - Tachyphylaxis (tachy = rapid; phylaxis = protection; acute tolerance):** When a drug is administered repeatedly at short intervals, the response diminishes rapidly. This is commonly seen with noncatecholamines, e.g. tyramine, ephedrine, amphetamine. These drugs act by releasing noradrenaline from the adrenergic nerve endings. Repeated administration of the drug causes gradual depletion of the neurotransmitter and hence reduction in the response (Fig. 1.13).

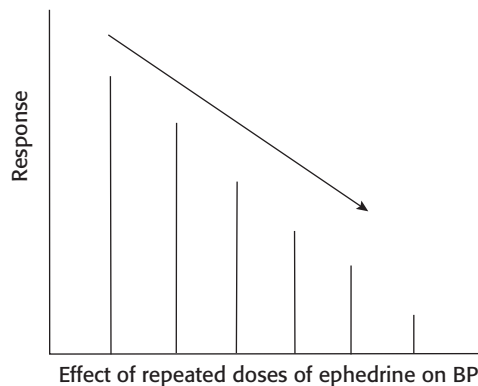

Fig. 1.13 Tachyphylaxis. BP: Blood pressure.

9. **Drug dependence:** See p. 38.

DRUG INTERACTIONS

When two or more drugs are administered simultaneously, the effects of one drug may be altered by the other drug.

Drug interactions can occur either *in vitro* (outside the body) or *in vivo* (inside the body).

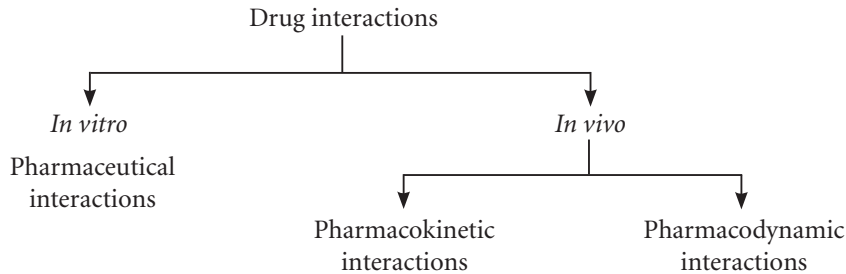

Drug interactions can result in either beneficial or harmful effects.

■ Pharmaceutical Interactions

These can occur as a result of incompatibility (physical or chemical) of a drug with an intravenous solution or when two or more drugs are mixed in the same syringe/i.v. infusion. This may result in precipitation or inactivation of one or more drugs.

Phenytoin should not be administered in dextrose solution as it gets precipitated.

Dextrose solution is not suitable for i.v. infusion of ampicillin, as it is unstable at acidic pH of dextrose.

Gentamicin and carbenicillin should not be given in the same infusion as it may result in loss of their potency.

■ Pharmacokinetic Interactions

These occur when one drug alters the absorption, distribution, metabolism or excretion of another drug.

Absorption: Antacids (containing aluminium, magnesium, calcium, iron, etc.) interfere with the absorption of tetracyclines by forming unabsorbable complexes with it.

Some drugs affect the absorption of other drugs by altering the gastrointestinal motility. Metoclopramide increases the rate of gastric emptying and promotes absorption of aspirin.

Distribution: Plasma protein binding can cause displacement interactions. More than one drug can bind to the same site on plasma protein. The drug with a higher affinity will displace the one with a lower affinity. This results in an increase in concentration of the unbound drug, e.g. salicylates displace warfarin from binding sites resulting in increased free warfarin levels and an enhanced anticoagulant effect (bleeding).

Metabolism: This occurs when metabolism of one drug is increased (enzyme induction) or decreased (enzyme inhibition) by another drug, e.g. carbamazepine induces the metabolizing enzyme of warfarin; thus enhancing its metabolism leading to a decreased anticoagulant effect.

Erythromycin inhibits the metabolizing enzyme of carbamazepine and increases its toxicity.

Excretion: Most of them occur in kidneys.

- Salicylates interfere with the excretion of methotrexate and potentiate its toxicity.
- Probenecid decreases the renal tubular secretion of penicillins and prolongs the duration of action of penicillins (beneficial interaction).

Pharmacodynamic Interactions

The interaction is due to the action of drugs on receptors or physiological system. This may result in either additive, synergistic or antagonistic effects (see p. 29). The interactions may also result in harmful effects, e.g. enhanced nephrotoxicity seen with the concurrent use of aminoglycosides and amphotericin B; it may also result in beneficial effect, e.g. levodopa and carbidopa in parkinsonism.

ADVERSE DRUG REACTIONS

Adverse Effect

Adverse effect is defined as any undesirable or unwanted effect due to drug administration. The WHO-suggested definition of adverse drug reactions (ADR) and adverse effects (AE) are as follows:

Adverse drug reaction (ADR): Any response that is noxious, unintended and which occurs at doses normally used in humans for prophylaxis, diagnosis or therapy of disease, or for modification of physiological function (WHO).

Adverse event (AE): Any untoward medical occurrence that may present during treatment with a pharmaceutical product but that does not necessarily have causal relationship with this treatment (WHO).

Predictable reactions (Type A or Augmented reactions): These are predictable reactions to a drug related to its pharmacological actions. They include side effects, secondary effects and toxic effects.

Unpredictable reactions (Type B or Bizarre reactions): These are nondose-related unpredictable reactions to a drug. They are not related to the pharmacological actions of the drug. Allergic reactions and idiosyncrasy are unpredictable reactions.

Adverse drug effects include the following:

Side Effects

These are the unwanted pharmacological effects of a drug that are seen with therapeutic doses, e.g. atropine used in the treatment of heart block also produces dryness of mouth, blurring of vision, urinary retention, etc., which are the side effects.

Secondary Effects

The primary action of a drug may result in other effects, e.g. immunosuppression by corticosteroids can lead to development of opportunistic infections, e.g. oral candidiasis.

Toxic Effects

These are the effects of a drug that are either due to overdosage or chronic use, e.g. bleeding due to chronic use/overdosage of anticoagulants and nephrotoxicity with aminoglycosides, especially in patients with renal failure.

Drug Allergy

It is an abnormal response (local or systemic) to a drug/foreign antigen mediated by the immune system. Different types of hypersensitivity reactions are discussed below.

- Those associated with humoral antibodies: *Types I, II and III.*
- Those associated with cell-mediated immunity: *Type IV* (delayed hypersensitivity).

Type I hypersensitivity (immediate type, anaphylactic shock): It is a rapidly occurring reaction; hence they are called immediate hypersensitivity reaction. The manifestations are itching, urticaria, hay fever, asthma or even anaphylactic shock.

IgE-mediated acute allergic reaction to certain drugs
(Penicillin, aspirin, lignocaine, etc.)



On re-exposure to the same drug



Ag:Ab reaction occurs on the mast cell surface

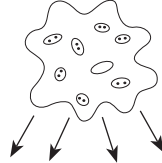

Release of mediators
(Histamine, 5-HT, PGs, LTs, PAF, etc.)



Hypotension, bronchospasm, angioedema, urticaria and rhinitis

It is a medical emergency and should be treated promptly with:

1. Inj. adrenaline (1:1000) 0.3–0.5 mL intramuscularly.
2. Inj. hydrocortisone 100–200 mg intravenously.
3. Inj. pheniramine 45 mg intramuscularly/intravenously.
4. Intravenous fluids.

Type II hypersensitivity (cytotoxic reaction): The antibodies (IgG and IgM) react with cell-bound antigen and cause activation of complement, which destroys the cells.

IgG- and IgM-mediated



The antibody reacts with cell-bound antigens

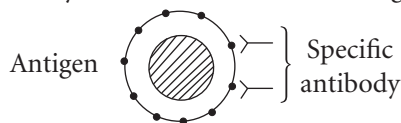

Activation of complement



Destruction of cells

Examples are blood transfusion reactions, haemolytic anaemias produced by quinine, quinidine, cephalosporins, etc.

Type III hypersensitivity (immune complex-mediated, Arthus reaction): In this type of reaction, antibodies involved are mainly IgG.

AG:AB complexes are formed → Fix complement → Deposition of complexes on vascular endothelium → Destructive inflammatory response.

For example, serum sickness (fever, urticaria, joint pain, lymphadenopathy) with penicillins and sulphonamides; acute interstitial nephritis with nonsteroidal antiinflammatory drugs (NSAIDs) and Stevens–Johnson syndrome with sulphonamides.

Type IV hypersensitivity (cell-mediated or delayed hypersensitivity): It is mediated by sensitized T lymphocytes. Re-exposure to the antigen leads to a local inflammatory response. The manifestations usually occur 1–2 days after exposure to the sensitizing antigen, e.g. contact dermatitis due to local anaesthetic creams, topical antibiotics and antifungal agents.

Type II, type III and type IV reactions are treated with glucocorticoids.

Idiosyncrasy

It is usually a genetically determined abnormal reaction to drugs, e.g. succinylcholine apnoea, aplastic anaemia caused by chloramphenicol, haemolytic anaemia seen with primaquine and sulphonamides.

Drug Dependence

World Health Organization (WHO) defines drug dependence as ‘a state—psychic and sometimes also physical—resulting from the interaction between a living organism and a drug, characterized by behavioural and other response that always includes a compulsion to take the drug on a continuous or periodic basis in order to experience its psychic effects and sometimes to avoid the discomfort of its absence’, e.g. opioids, alcohol, barbiturates, amphetamine, etc. The dependence could be psychological or physical.

1. **Psychological dependence:** There is an intense desire to continue taking the drug as the patients feel that their well-being depends upon the drug.
2. **Physical dependence:** Repeated drug use produces physiological changes in the body that makes continuous presence of the drug in the body necessary to maintain normal function. Abrupt stoppage of the drug results in an imbalance wherein the body has to readjust to the absence of the drug resulting in the development of signs and symptoms known as *withdrawal syndrome*. The withdrawal signs and symptoms are generally opposite to the effects produced by the drug.

Principles of treatment of drug dependence are:

1. **Hospitalization.**
2. **Substitution therapy:** e.g. Methadone/buprenorphine substitution for morphine addiction.
3. **Aversion therapy:** Disulfiram for alcohol addiction.
4. **Psychotherapy.**
5. **General measures:** Maintain nutrition, family support and rehabilitation.

▮ Iatrogenic Diseases

It is physician-induced disease (*'Iatros'* is a Greek word, means 'physician') due to drug therapy, e.g. parkinsonism due to metoclopramide; acute gastritis and peptic ulcer due to nonsteroidal anti-inflammatory drugs.

▮ Teratogenicity

Certain drugs when given during pregnancy may cross the placenta and cause various dangerous effects in the foetus (Table 1.7). This is called teratogenesis.

Administration of drugs during *early pregnancy* (from conception to 16 days) could result in abortion; during *2–8 weeks* of gestation, it can affect organogenesis and produce structural abnormalities; during *second and third trimester*, drugs can affect growth and development of the foetus. Hence, drug administration during pregnancy should be restricted.

Table 1.7 Teratogenic Effect of Some Drugs

Drug	Teratogenic Effect
Thalidomide	Phocomelia
Tetracyclines	Yellowish discolouration of the teeth
Antithyroid drugs	Foetal goitre

▮ Carcinogenicity and Mutagenicity

The ability of a drug to cause cancer is *carcinogenicity* and the agent is known as *carcinogen*. The abnormalities of genetic material in a cell produced by a drug are known as *mutagenicity*, e.g. anticancer drugs and oestrogens.

▮ Photosensitivity Reactions

It is a drug-induced cutaneous reaction following exposure to ultraviolet radiation, e.g. demeclocycline, doxycycline, etc.

▮ Hepatotoxicity

Some of the hepatotoxic drugs are isoniazid, rifampicin, pyrazinamide, halothane, paracetamol, etc.

▮ Nephrotoxicity

Aminoglycosides, amphotericin B, cisplatin, cyclosporine, heavy metals, etc. are nephrotoxic drugs.

▮ Ototoxicity

It can occur with aminoglycosides, loop diuretics, cisplatin, etc.

▮ Ocular Toxicity

Ethambutol, chloroquine, glucocorticoids, etc. can cause ocular toxicity.

■ Pharmacovigilance

It is the science and activities relating to detection, assessment, understanding and prevention of adverse effects or any other possible drug-related problems (WHO). The aim of pharmacovigilance is to improve patient care and safety related to use of drugs, promote rational use of medicines, develop regulations for use of drugs and educate healthcare professionals about adverse drug reactions.

Causality assessment: Some of the commonly used tools for causality assessment are Naranjo's scale and WHO scale.

The National Pharmacovigilance Centre is located at Ghaziabad. The International Centre is located in Sweden—Uppsala Monitoring Centre. Any healthcare professional, e.g. doctors, dentists, nurses and pharmacists can report a suspected adverse drug event.

TREATMENT OF POISONING

■ Poisoning

Toxicology is the study of poisons—their actions, detection, prevention and treatment of poisoning. All poisoning cases require hospitalization and careful observation till recovery. Poisoning may be suicidal, homicidal or accidental. All cases of poisoning are medicolegal cases; hence the police should be informed.

General management

1. Hospitalization.
2. Airway should be cleared. In comatose patients, there is danger of respiratory obstruction by tongue, secretions and aspiration of vomitus. Hence, patient should be turned to his left lateral side. A cuffed endotracheal tube should be inserted and secretions should be aspirated regularly.
3. Breathing should be assessed. If there is hypoxaemia, oxygen should be given. Patient may need mechanical ventilation, if there is respiratory insufficiency.
4. Circulation should be assessed (pulse rate and blood pressure) and an i.v. (intravenous) line should be maintained.
5. To prevent further absorption of poison:
 - a. *Inhaled poisons (gases):* Patient should be moved to fresh air.
 - b. *Contact poisons:* Contaminated clothes should be removed and the body part should be washed with soap and water.
 - c. *Ingested poisons:* Gastric lavage can limit the absorption if done within 2–3 h of poisoning. If patient is unconscious, endotracheal intubation should be done before gastric lavage. Gastric lavage is usually done with normal saline. Other solutions used are lukewarm water, potassium permanganate solution, sodium bicarbonate, etc. Lavage should be repeated till the returning fluid is clear. After the lavage, activated charcoal is added to the stomach, which adsorbs many drugs and poisons (physical antagonism). Activated charcoal has a large surface area and is highly porous to bind with poisonous material. Gastric lavage should not be carried out in case of poisoning due to corrosives (except carbolic acid) due to fear of perforation, petroleum products (kerosene), convulsants, etc.

Mustard, common salt, syrup ipecac, etc. can be used to induce vomiting and prevent further absorption of ingested poisons. However, this method is rarely practiced now.

Laxatives like magnesium sulphate or citrate can be used orally to promote elimination of the ingested poison. Oral polyethylene glycol electrolyte solution can be used for whole-bowel irrigation of the gastrointestinal tract in case of poisoning due to iron, lithium, cocaine, heroin, foreign bodies, etc.

6. To promote elimination of absorbed portion of the drugs:
 - a. **Diuretics** (i.v. mannitol or furosemide) are used to promote the elimination of absorbed portion of the drug. Renal elimination of some of the drugs can be increased by altering the pH of urine, e.g. alkalization of urine in salicylate poisoning and acidification of urine in amphetamine poisoning.
 - b. **Dialysis** is used in cases of severe poisoning, e.g. lithium, aspirin, methanol, etc.
7. Symptomatic treatment: Intravenous diazepam 5–10 mg if there are convulsions and external cooling for hyperpyrexia.
8. Maintenance of Fluid and Electrolyte balance: Hyponatraemia should be treated with i.v. normal saline and hypernatraemia with i.v. furosemide. Hypokalaemia is treated with potassium chloride, oral or slow i.v. infusion. Oral potassium chloride should be diluted in a tumbler of water to prevent intestinal ulceration. Potassium chloride should be given slow intravenously as it has cardiac depressant effect. Rapid injection can cause cardiac arrest and death. Thiazides or furosemide can be used to treat mild hyperkalaemia. Severe hyperkalaemia is treated with 10% calcium gluconate intravenously. Intravenous sodium bicarbonate is used to treat metabolic acidosis.

Note: Mnemonic for general management of poisoning: **A–H**.

Specific management: Antidotes for some poisons are listed in Table 1.8.

Table 1.8 Antidotes for Various Poisons

Poison	Antidote
Alkalies	Dilute acetic acid
Organophosphorus compounds	Atropine
Morphine (opioids)	Naloxone
Atropine	Physostigmine
Benzodiazepines	Flumazenil
Carbamates	Atropine
Cyanide	Sodium nitrite and sodium thiosulphate
Methanol	Ethyl alcohol
Paracetamol	N-Acetylcysteine
Heparin	Protamine sulphate
Warfarin	Vitamin K ₁ (phytonadione)
Iron compounds	Desferrioxamine

This page intentionally left blank

Drugs can be administered to a patient in various forms. They are available as solid, semisolid and liquid dosage forms.

SOLID DOSAGE FORMS

Solid dosage forms of a drug are tablet, capsule, powder, suppository, troche, lozenge, etc.

Tablet: It is the commonly used solid dosage form (Fig. 2.1a,b). A tablet may be scored and can be easily broken along the line, if required, e.g. paracetamol. Tablets can be uncoated or coated (covered with a thin film of another substance) to improve the taste, delay absorption, prevent its degradation in the stomach, etc. Sugar coating of a tablet helps to improve its taste, e.g. metronidazole.

- **Enteric-coated tablet:** It is coated with a material that delays the release of medication till it reaches the intestine. Enteric coating of a drug prevents the destruction of the drug by gastric acid, e.g. enteric-coated tablet of erythromycin, or decreases the gastric irritation by the drug, e.g. enteric-coated tablet of diclofenac.
- **Sustained-release preparations:** They help to prolong the duration of action of a drug, thereby decreasing the frequency of drug administration and improving patient compliance, e.g. sustained-release tablet of diclofenac (for pain).
- **Chewable tablet:** It should be chewed and swallowed. This helps to increase the effectiveness of the drug, e.g. chewable antacid tablet used for gastritis and chewable albendazole tablet for worm infestation.
- **Dispersible tablet:** It is a tablet that has to be dispersed in water or milk before administration, e.g. aspirin dispersible tablet.

Solid dosage forms

- Tablet
- Capsule
- Troche
- Lozenge
- Suppository
- Pellet
- Powder

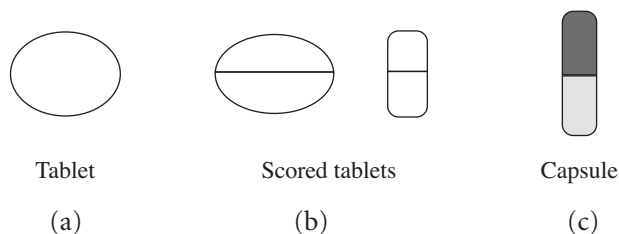

Fig. 2.1 (a) Tablet, (b) scored tablets and (c) capsule.

Capsule: It is a solid dosage form where the drug is enclosed within a soluble sheath. Capsules can be oval, cylindrical or spherical (Fig. 2.1c), e.g. amoxicillin.

Sustained-release and enteric-coated capsules are also available. Spansules and timsules are sustained-release forms. Time-release forms may have the suffix like SR (sustained release), CR (controlled release), ER (extended release), SA (sustained action), contin (continuous), retard, etc.

Troche: It is a solid dosage form to be placed in the mouth where it dissolves slowly to liberate the active ingredient. For example, clotrimazole troche for oral candidiasis (oral thrush).

Lozenge: It is a solid dosage form placed in the mouth and sucked; it dissolves slowly to liberate the active ingredient. It soothes the irritated mucosa of the throat. Some lozenges have systemic effect, e.g. nicotine lozenges to reduce withdrawal symptoms and craving associated with cessation of smoking; dyclonine (local anaesthetic) lozenge for sore throat.

Suppository: A solid dosage form that is inserted into the rectum, e.g. bisacodyl suppository for constipation.

Powder: It is the finely divided form of a drug for internal or external use, e.g. oral rehydration salt (ORS) powder for dehydration, tooth powder for cleaning the teeth, etc.

SEMISOLID DOSAGE FORMS

Different types of semisolid dosage forms are as follows:

Ointment: It is a semisolid preparation with a greasy base usually meant for application to skin or mucosa, e.g. lignocaine ointment for local anaesthesia, acyclovir ointment for herpetic infections.

Cream: It is a semisolid emulsion for local application, e.g. antifungal agent (nystatin cream) for oropharyngeal candidiasis; antiviral agents (acyclovir and penciclovir cream) for herpetic labialis; glucocorticoid (betamethasone and clobetasol) intraoral cream for severe aphthous stomatitis.

Paste: It is a semisolid preparation with a less-greasy base generally meant for topical use, e.g. triamcinolone acetonide paste for oral inflammatory conditions. Pastes are stiffer and easily washable than ointments.

Gel: It is a jelly-like substance formed by the aqueous suspension of insoluble drugs, e.g. diclofenac gel for pain, lignocaine gel as a local anaesthetic, povidone iodine gel for sore throat, glucocorticoid (betamethasone and clobetasol) gel for severe aphthous stomatitis.

LIQUID DOSAGE FORMS

Different types of liquid dosage forms are as follows:

Mixture: It is a liquid containing two or more ingredients for oral use. For example, sodium salicylate mixture as an analgesic and antipyretic; gripe water mixture used in infant to reduce gripping; carminative mixture to expel gas from the stomach and the intestine.

Emulsion: It is a mixture of two immiscible liquids (e.g. oil and water) made miscible by using an emulsifying agent, e.g. cod-liver-oil emulsion for vitamin D deficiency.

Suspension: It contains one or more insoluble ingredients suspended in a liquid, e.g. antacid suspension, amoxicillin suspension, etc. It should be shaken well before use.

Syrup: It is a concentrated solution of sugar containing the drug to mask the bitter taste of the drug, e.g. cough syrup.

Elixir: It is a clear, pleasantly flavoured liquid dosage form that contains a drug dissolved in water and alcohol, e.g. promethazine elixir for suppressing dry cough.

Linctus: It is a viscous liquid preparation that should be sipped slowly to allow it to trickle down the throat. It is usually used for relief of cough, e.g. linctus codeine.

Gargle: An aqueous solution used to prevent or treat throat infections, e.g. saline gargle for sore throat.

Mouth rinses: An aqueous solution used for rinsing the mouth for oral hygiene, e.g.:

- Antiseptic mouth rinse (chlorhexidine or povidone iodine) used in gingivitis.
- Astringent mouth rinse (tannic acid) is used for gingivitis and aphthous ulcers.
- Anticaries mouth rinse (sodium fluoride) to prevent dental caries.

Tincture: It is an alcoholic preparation of a drug, e.g. tincture of iodine used as an antiseptic.

Paint: It is a liquid preparation of a drug for application to the skin or mucosa, e.g.

Mandl's paint (iodine in potassium iodide) for sore throat, tonsillitis, pharyngitis; astringent gum paint (tannic acid) for gingivitis and antiseptic gum paint (tincture iodine with phenol) for gingivitis, after scaling, etc.

Irrigation solutions: They are used for washing out a body cavity or wound and the procedure is known as irrigation. Water, saline and antiseptic solutions can be used as irrigants. Oral irrigation can be done for preventing and treating inflammatory conditions of the oral cavity.

Drops: They are liquid preparations meant for oral (vitamin drops, paracetamol drops) or local (eye, ear and nose) administration.

Spray: It discharges the drug in droplet form for topical application, e.g. lignocaine spray for local anaesthesia, nitroglycerine lingual spray for angina attack.

Liquid dosage forms

- Mixture
- Emulsion
- Suspension
- Syrup
- Elixir
- Linctus
- Gargle
- Mouth rinses
- Tincture
- Paint
- Irrigation solutions
- Drops
- Spray

INJECTABLE DOSAGE FORMS

The drugs to be administered as injections are available as follows:

Powder for injection: The powder is mixed (reconstituted) with a diluent, e.g. sterile water or normal saline before administration to a patient. The drug should dissolve completely before administration, e.g. benzyl penicillin G.

Suspension for injection: Insoluble or sparingly soluble drugs are suspended in oily or aqueous vehicle, e.g. procaine penicillin G.

Solution for injection: It is administered as such, e.g. adrenaline.

NEW DRUG-DELIVERY SYSTEMS

- **Orodonal patch,** e.g. lignocaine patch for local anaesthesia.

- **Microspheres**, e.g. minocycline microspheres for periodontitis.
- **Computer-controlled local anesthetic delivery devices**.
- **Iontophoresis**, e.g. to deliver salicylates for deep-seated pain.
- **Nanoparticles**, e.g. nanoparticles loaded with chlorhexidine for antibacterial action.

Key Points for Dentists

- ↳ Enteric-coated and sustained-release formulations should not be chewed.
- ↳ All instructions should be carefully read before administering a drug.

Drugs Acting on Autonomic Nervous System

INTRODUCTION TO AUTONOMIC PHARMACOLOGY

The nervous system is divided into central nervous system (CNS: brain and spinal cord) and peripheral nervous system (PNS). PNS can be further divided into somatic nervous system and autonomic nervous system (ANS). The differences between these two systems are given in Table 3.1.

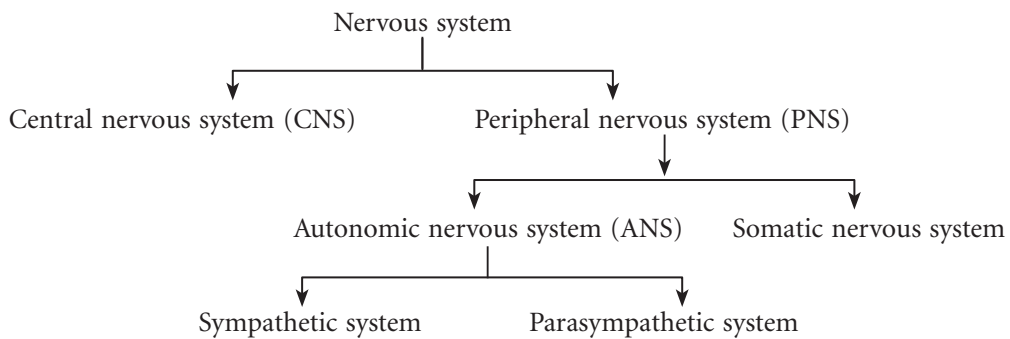

Table 3.1 Differences Between ANS and Somatic Nervous System

Autonomic Nervous System	Somatic Nervous System
<i>Auto</i> : self; <i>nomos</i> : governing; this system is involuntary and maintains homeostasis	Somatic nervous system is under voluntary control
Each autonomic fibre is made up of two neurons arranged in series	Each somatic fibre is made up of single motor neuron, which connects CNS to skeletal muscle
It innervates the heart, smooth muscles and exocrine glands	It innervates skeletal muscle
It controls visceral functions such as circulation, digestion, excretion, etc.	It controls skeletal muscle tone

The ANS has two divisions—sympathetic and parasympathetic (Fig. 3.1).

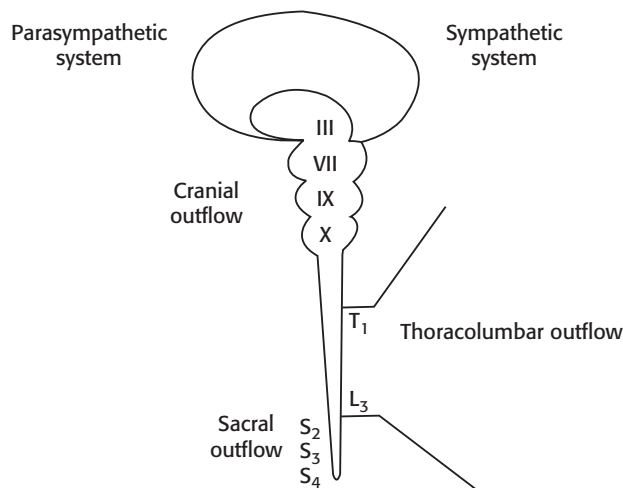

Fig. 3.1 Divisions of ANS.

The sympathetic division arises from thoracolumbar region (T₁–L₃, thoracolumbar outflow) and the parasympathetic division arises from two separate regions in the CNS. The cranial outflow arises from cranial nerves (III, VII, IX and X) and sacral outflow from S₂, S₃, and S₄ spinal roots.

In the sympathetic system, the preganglionic fibres are short and postganglionic fibres are long. On the other hand, the parasympathetic preganglionic fibres are long and postganglionic fibres are short (Fig. 3.2). Most of the visceral organs have dual nerve supply, i.e. they are supplied by both divisions of the ANS, but effects of one system predominate. The ciliary muscle, pancreatic and gastric glands receive only parasympathetic supply; sweat glands, hair follicles, spleen and most of the blood vessels have only sympathetic supply. Their stimulation usually produces opposite effect on the innervating organ (Fig. 3.3).

CHOLINERGIC SYSTEM

■ Cholinergic Transmission

Acetylcholine (ACh) is the main neurotransmitter in the cholinergic system. The neurons that synthesize, store and release ACh are called cholinergic neurons (Fig. 3.4, p. 50).

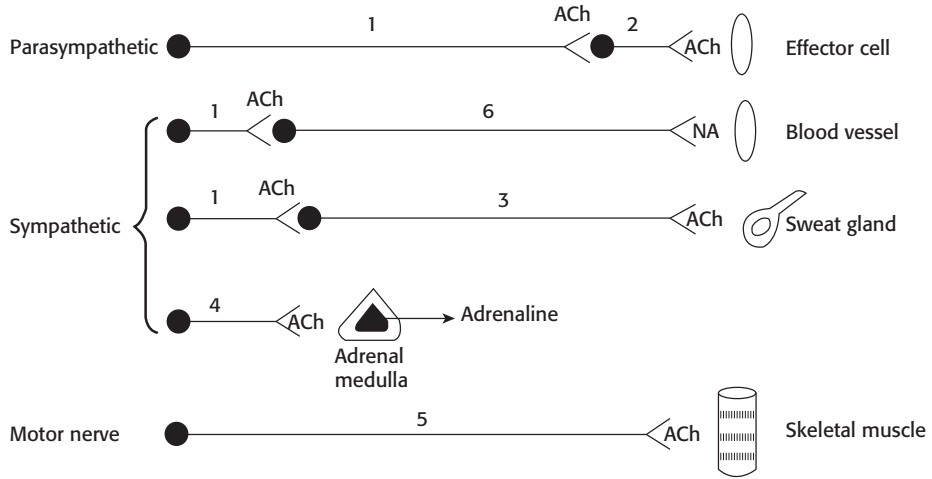

Fig. 3.2 Sites of acetylcholine (ACh) and noradrenaline (NA) release in the PNS: 1, preganglionic fibres of both sympathetic and parasympathetic system; 2, postganglionic fibres of parasympathetic system; 3, sympathetic postganglionic fibres supplying the sweat glands; 4, nerve fibres supplying the adrenal medulla; 5, motor nerve; 6, postganglionic fibres of sympathetic system that release NA. In addition, certain neurons in the brain and spinal cord release ACh and NA.

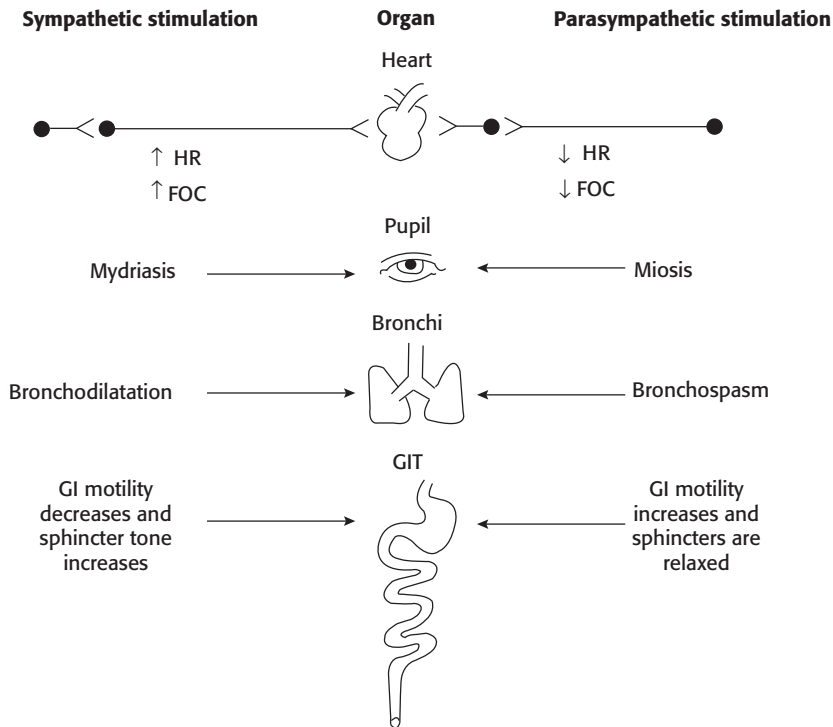

Fig. 3.3 Effects of sympathetic and parasympathetic stimulation on various organs. HR, heart rate; FOC, force of contraction; GIT, gastrointestinal tract.

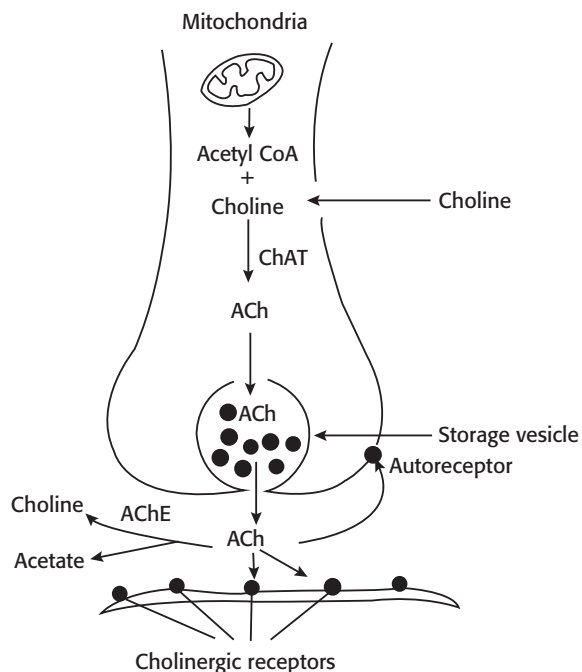

Fig. 3.4 Synthesis, storage and fate of the released ACh at the cholinergic nerve endings. ChAT, choline acetyltransferase; AChE, acetylcholinesterase.

■ Synthesis of Acetylcholine (Fig. 3.4)

Choline enters the cholinergic neuron by carrier-mediated transport, where it reacts with acetyl-CoA with the help of choline acetyltransferase (ChAT) to form ACh. The ACh is then stored in storage vesicles. It is released into the synaptic cleft, when an action potential reaches the nerve terminals. The released ACh interacts with cholinergic receptors on effector cell and activates them. In the synaptic cleft, the ACh is rapidly hydrolysed by acetylcholinesterase (AChE) enzyme.

■ Cholinesterases

Acetylcholine is rapidly hydrolysed to choline and acetic acid by the enzyme cholinesterase. There are two types of cholinesterases:

1. **True cholinesterase or AChE:** It is found in cholinergic neurons, ganglia, RBCs and neuromuscular junction (NMJ). It rapidly hydrolyses ACh and a choline ester, methacholine.
2. **Pseudocholinesterase or butyrylcholinesterase:** It is found in plasma, liver and glial cells. Pseudocholinesterase can act on a wide variety of esters including ACh, but it does not hydrolyse methacholine.

Cholinergic Receptors

They are divided broadly into two types—muscarinic and nicotinic. Muscarinic receptors are further divided into five different subtypes: M_1 – M_5 . All muscarinic receptors are G-protein-coupled receptors and regulate the production of intracellular second messengers.

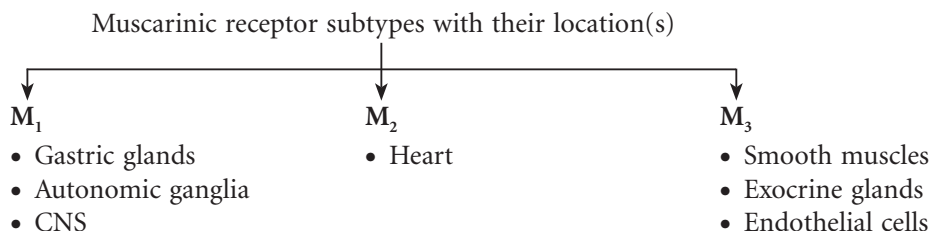

Nicotinic receptors are divided into two subtypes— N_N and N_M . Activation of these receptors directly opens the ion channels and causes depolarization of the membrane. The characteristics of muscarinic and nicotinic receptors are shown in Table 3.2.

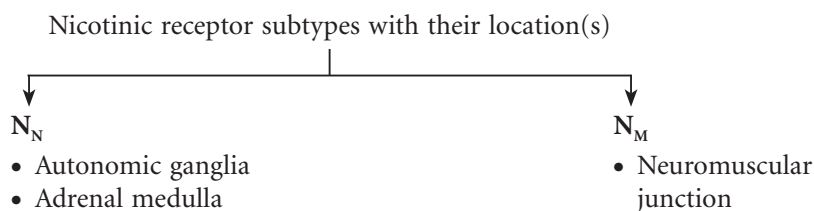

Table 3.2 Characteristics of Muscarinic and Nicotinic Receptor Subtypes

Receptor Type(s)	Functional Response
M_1 and M_3	Promotes glandular secretion and smooth muscle contraction
M_2	Depressant effect on heart
N_N	Depolarization
N_M	Skeletal muscle contraction

CHOLINERGIC AGENTS (CHOLINOMIMETICS, PARASYMPATHOMIMETICS)

Acetylcholine is a quaternary ammonium compound and is rapidly hydrolysed by cholinesterases. Hence, it has no therapeutic application. It has to be given intravenously to study its pharmacological actions. Even when given intravenously, a large amount of the drug is destroyed by pseudocholinesterase in the blood.

Classification

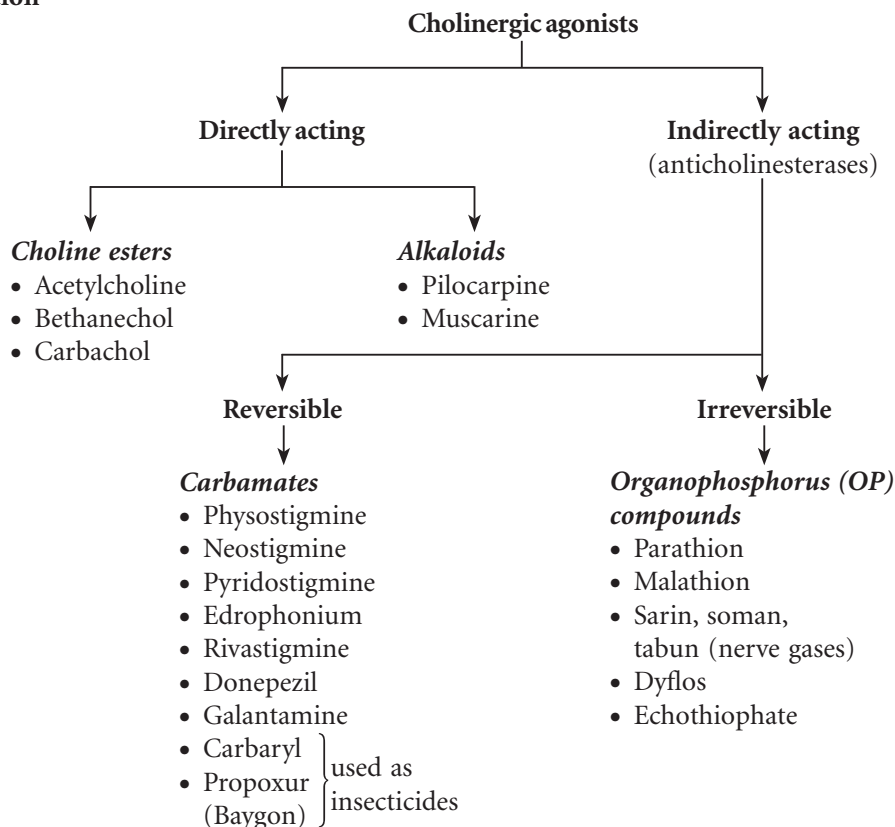

■ Choline Esters

Choline esters include acetylcholine, carbachol and bethanechol.

▮ Acetylcholine

Acetylcholine produces muscarinic and nicotinic effects by interacting with respective receptors on the effector cells (Table 3.3, p. 53).

Muscarinic actions

1. Cardiovascular system

- a. *Heart*: The effects of ACh are similar to those following vagal stimulation. ACh, by stimulating M_2 receptors of the heart, opens K^+ channels resulting in hyperpolarization. Therefore, S–A and A–V nodal activity is reduced (Fig. 3.5).

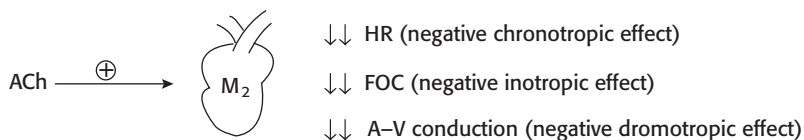
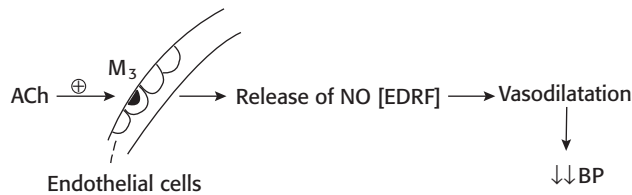

Fig. 3.5 The effects of acetylcholine (ACh) on heart.

Table 3.3 Pharmacological Actions and Uses of Choline Esters

	Acetylcholine	Carbachol	Bethanechol
Metabolized by	True and Pseudocholinesterase enzymes	Resistant to both the enzymes	Resistant to both the enzymes
Muscarinic actions	+	+	+
Nicotinic actions	+	+	-
Effect of atropine	Muscarinic actions are completely blocked by atropine	Muscarinic actions are not completely blocked by atropine	Muscarinic actions are completely blocked by atropine
Uses	Not useful in therapy because of very short duration of action	Glaucoma	Postoperative urinary retention, paralytic ileus and dry mouth

- b. *Blood vessels*: Acetylcholine stimulates the M_3 receptors of vascular endothelial cells, which release endothelium-dependent relaxing factor (EDRF; NO), leading to vasodilatation and a fall in blood pressure (BP) (Fig. 3.6).

**Fig. 3.6** The effect of acetylcholine (ACh) on blood vessels.

2. Smooth muscles

- a. *Gastrointestinal tract* (Fig. 3.7)

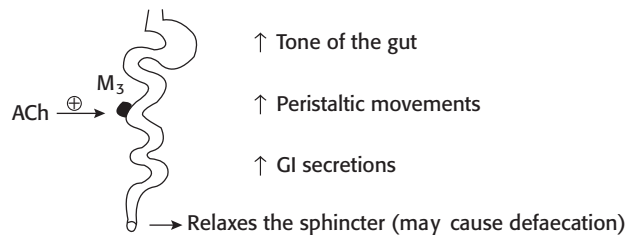
**Fig. 3.7** The effect of acetylcholine (ACh) on gastrointestinal (GI) tract.

- b. *Urinary bladder* (Fig. 3.8)

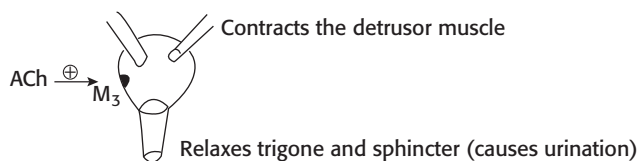
**Fig. 3.8** The effect of acetylcholine (ACh) on urinary bladder.

c. *Bronchi* (Fig. 3.9)

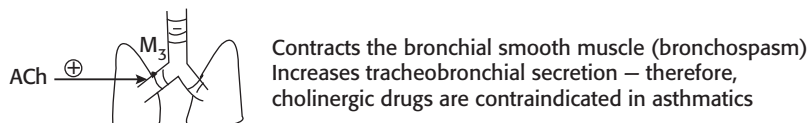

Fig. 3.9 The effect of acetylcholine (ACh) on bronchi.

- 3. Exocrine glands:** All parasympathomimetic agents stimulate salivary secretion. They also increase lacrimal, sweat, bronchial, gastric and other gastrointestinal (GI) secretions.
- 4. Eye** (Fig. 3.10): Acetylcholine does not produce any effect on topical administration because of its poor penetration through tissues.

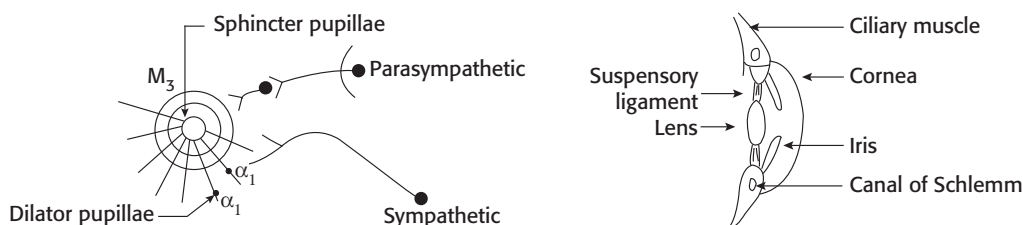
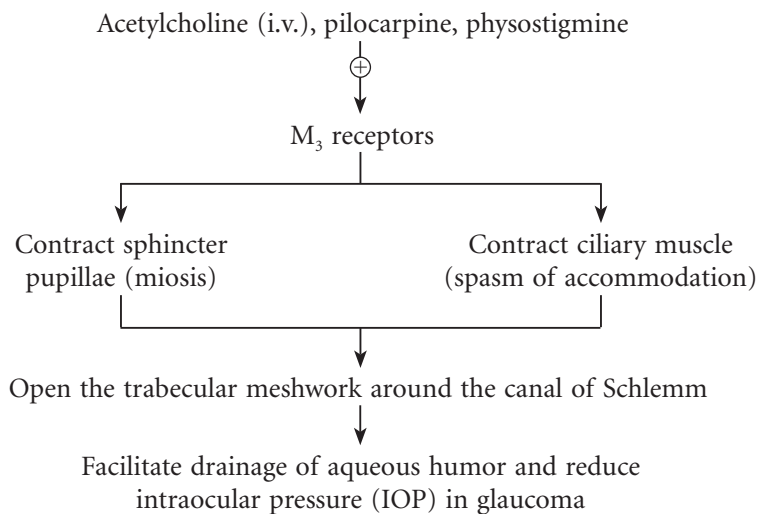

Fig. 3.10 Autonomic innervation of the eye.

Action of muscarinic agonists on eye can be depicted as follows:



Nicotinic actions

To elicit nicotinic actions, larger doses of ACh are required.

- 1. Autonomic ganglia:** Higher doses of ACh produce dangerous muscarinic effects, especially on the heart. Hence, prior administration of atropine is necessary to elicit nicotinic actions.

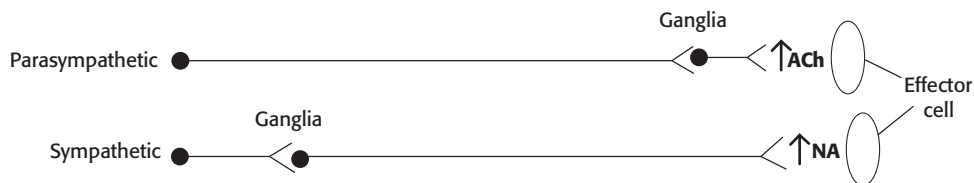

Fig. 3.11 Stimulation of parasympathetic and sympathetic ganglia.

Higher doses of ACh stimulate both sympathetic as well as parasympathetic ganglia (Fig. 3.11), causing tachycardia and a rise in BP.

2. **Skeletal muscles:** At high concentration, ACh initially produces twitching, fasciculation followed by prolonged depolarization of NMJ and paralysis.
3. **CNS:** Intravenously administered ACh does not cause any central effects because of its poor penetration through the blood–brain barrier (BBB).

▮ Bethanechol

It has selective muscarinic actions on gastrointestinal tract (GIT) and urinary bladder. It is preferred in postoperative urinary retention and paralytic ileus because:

- It has a wide margin of safety.
- It has no nicotinic actions.
- Its muscarinic side effects are completely antagonized by atropine.
- In urinary retention, it causes voiding of urine by contracting the detrusor muscle and relaxing the trigone sphincter.
- In paralytic ileus, it stimulates peristaltic movement and increases the tone by interacting with M_3 receptors of the gut.

■ Cholinomimetic Alkaloids

They mimic the actions of acetylcholine; examples are pilocarpine, muscarine and arecoline.

▮ Pilocarpine

Pilocarpine is a cholinomimetic alkaloid obtained from *Pilocarpus* plant. It is a tertiary amine. It produces muscarinic and nicotinic effects by directly interacting with the receptors. It has predominant muscarinic actions especially on secretory activity.

Uses

1. Pilocarpine is used as a **sialagogue** (drug used to augment salivary secretion). It can be used cautiously by oral route in **xerostomia** (dry mouth) that follows head and neck radiation treatment. Other sialagogues are cevimeline and bethanechol. Cevimeline (30 mg TDS), an M_3 agonist can be used to treat xerostomia and dry eyes. It is long acting and has fewer side effects compared to pilocarpine. Bethanechol can also be used in xerostomia and has lesser diaphoretic (sweating) effect.
2. **Sjögren's syndrome:** It is an autoimmune disorder characterized by dryness of all mucosae (dry eyes, dry mouth, etc). Pilocarpine can be used orally 5 mg three times daily with food.

- Pilocarpine 0.5–4% solution is used topically in the treatment of **open-angle and acute congestive glaucomas**. Like ACh, it also causes miosis by contracting sphincter pupillae, opens the trabecular meshwork around the Schlemm's canal, facilitates the drainage of aqueous humour and reduces the intraocular pressure (IOP). It acts rapidly but has a shorter duration of action. Pilocarpine ocusert that releases the drug slowly over 7 days is available.
- Pilocarpine is used alternatively with mydriatics **to break adhesions between the iris and the lens**.
- Pilocarpine is used **to reverse pupillary dilatation** after refraction testing.

Adverse effects

They are salivation, sweating, bradycardia, diarrhoea, bronchospasm; pulmonary oedema can occur following systemic therapy.

■ Muscarine

It is an active ingredient of poisonous mushroom, *Amanita muscaria*. It has no therapeutic application.

■ Arecoline

It is an alkaloid obtained from areca nut. It has muscarinic and nicotinic actions similar to choline esters.

■ Anticholinesterases

They inhibit the enzyme cholinesterases, which is responsible for hydrolysis of acetylcholine. Thus, ACh is not metabolized, gets accumulated at muscarinic and nicotinic sites, and produces cholinergic effects. Hence, anticholinesterases are called indirectly acting cholinergic drugs.

■ Reversible Anticholinesterases

- Physostigmine
- Neostigmine
- Pyridostigmine
- Edrophonium
- Rivastigmine
- Donepezil

Mechanism of action: ACh is rapidly hydrolysed by both true and pseudocholinesterases.

Reversible anticholinesterases inhibit both true and pseudocholinesterases reversibly—thus, ACh gets accumulated and produces cholinergic effects.

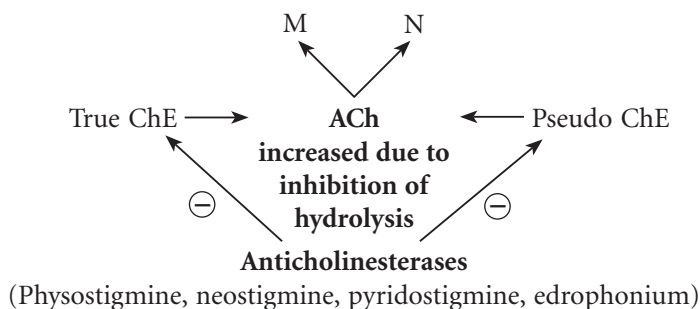

Physostigmine (Eserine): It is an alkaloid obtained from *Physostigma venenosum*. It is a tertiary amine and has good penetration through tissues. Its actions are similar to those of other cholinergic agents.

Uses

1. **Glaucoma:** Physostigmine reduces IOP by producing miosis, thus it facilitates the drainage of aqueous humour. On chronic use, it accelerates cataract formation; hence it is rarely used in glaucoma.
2. **Atropine poisoning:** Intravenous physostigmine is used for severe atropine and other antimuscarinic drug poisoning because it has both central and peripheral actions. It competitively reverses the effects of atropine poisoning; but it should be used cautiously by slow i.v. injection as it may cause bradycardia.

Neostigmine (Table 3.4): Neostigmine is a synthetic anticholinesterase agent. Its actions are pronounced on NMJ, GIT and urinary bladder than on cardiovascular system (CVS) or eye. On skeletal muscle, it has both direct and indirect actions.

- **Indirect actions** (see the above flowchart): By inhibiting cholinesterases, neostigmine increases ACh concentration at NMJ.
- **Direct action:** Because of structural similarity with ACh (i.e. quaternary ammonium compound), neostigmine also directly stimulates the N_M receptors at NMJ. Thus, it improves muscle power in patients with myasthenia gravis.

Neostigmine does not cross BBB and has no central side effects. It is available for oral, s.c. and i.m. administration.

Table 3.4 Comparative Aspects of Physostigmine and Neostigmine

Physostigmine	Neostigmine
Natural alkaloid obtained from <i>Physostigma venenosum</i>	Synthetic
Tertiary amine, has good penetration through tissues, hence topically effective	Quaternary ammonium compound, has poor penetration, hence topically not effective
Crosses BBB—produces both central and peripheral effects	Does not cross BBB; hence no central effects
Uses: <ul style="list-style-type: none"> • Atropine poisoning • Glaucoma 	Uses: <ul style="list-style-type: none"> • Postoperative urinary retention and paralytic ileus • Myasthenia gravis • Curare poisoning

Pyridostigmine: All features are same as neostigmine. Pyridostigmine has a longer duration of action and can be given twice daily in sustained-release form; hence it is preferred over neostigmine in myasthenia gravis. Even though pyridostigmine is less potent than neostigmine, it is better tolerated by myasthenic patients.

Edrophonium: It is a quaternary ammonium compound. On i.v. administration, it has a rapid onset but short duration of action (5–15 min).

Uses

1. Edrophonium is used in the diagnosis of myasthenia gravis.
2. It is used to differentiate myasthenic crisis from cholinergic crisis.
3. In curare poisoning, edrophonium is preferred because of its rapid onset of action.

Adverse Effects of Anticholinesterases

They are due to overstimulation of both muscarinic and nicotinic receptors—increased sweating, salivation, nausea, vomiting, abdominal cramps, bradycardia, diarrhoea, tremors and hypotension.

Therapeutic Uses of Reversible Anticholinesterases

1. Eye.
 - a. Glaucoma.
 - b. To reverse pupillary dilatation after refraction testing.
 - c. Miotics are used alternatively with mydriatics to break adhesions between iris and lens.
2. Myasthenia gravis.
3. Belladonna poisoning.
4. Curare poisoning and reversal of nondepolarising neuromuscular blockade.
5. Postoperative urinary retention and paralytic ileus.
6. Alzheimer's disease.

Glaucoma

The aqueous humour formed by the ciliary process is drained mainly through trabecular meshwork (Fig. 3.12).

Glaucoma is a progressive optic neuropathy, which leads to damage of optic nerve with loss of visual function, that is frequently associated with raised IOP. Normal IOP varies between 10 and 20 mmHg. Management of this disorder is almost always directed at lowering the existing IOP either by improving drainage or decreasing the formation of aqueous humour (Fig. 3.12). The two clinical types of glaucoma are acute, congestive and chronic simple glaucoma.

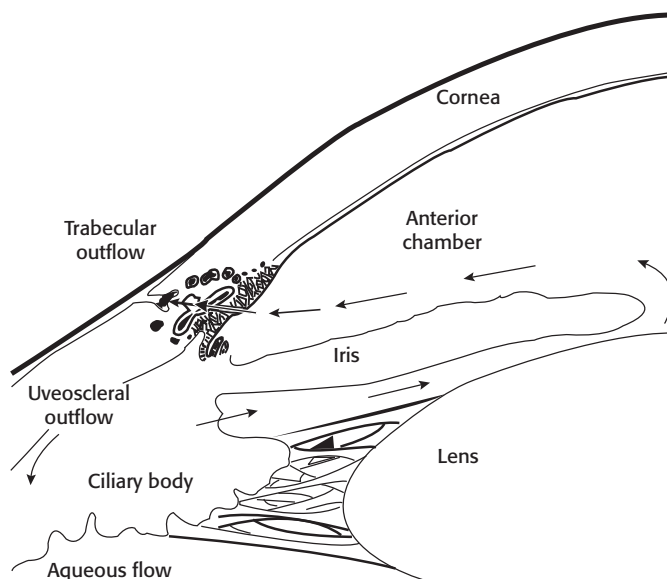

Fig. 3.12 Aqueous humour secretion and its pathway.

Acute congestive glaucoma: It is usually precipitated by mydriatics in people with narrow iridocorneal angle and shallow anterior chamber. Acute congestive glaucoma is always a medical emergency. Once the attack is controlled, treatment is surgical or laser iridotomy.

Chronic simple glaucoma: It is a genetically predisposed condition affecting the patency of trabecular meshwork. The IOP rises gradually. Pharmacotherapy is the definitive treatment in a majority of cases.

Drugs for glaucoma (Table 3.5)

1. **Osmotic agents:** Mannitol (20%) i.v. infusion (1.5 g/kg body weight) and 50% glycerol oral (1.5 g/kg) are used. They draw fluid from the eye into the circulation by osmotic effect and reduce IOP.
2. **Carbonic anhydrase inhibitors:** Acetazolamide (oral, i.v.), dorzolamide (topical) and brinzolamide (topical) are carbonic anhydrase inhibitors. They non-competitively inhibit carbonic anhydrase enzyme and lower IOP by decreasing the formation of aqueous humour. Topical carbonic anhydrase inhibitors, which have a much lower risk of systemic side effects, are preferred over systemic carbonic anhydrase inhibitors in chronic simple glaucoma. In acute congestive glaucoma, acetazolamide is administered i.v. and orally.
3. **β -Adrenergic blockers:** They decrease the production of aqueous humour. Topical nonselective β -blockers are timolol, betaxolol, levobunolol and carteolol. Timolol is widely used in glaucoma because (i) it lacks local anaesthetic property, (ii) it does not affect pupil size or accommodation, (iii) it has longer duration of action, (iv) it is well tolerated, (v) it is less expensive, (vi) topical timolol is safer and highly effective. Betaxolol is a selective β_1 -blocker used in glaucoma, but it is less effective than nonselective agents. β -Blockers should be cautiously used or contraindicated in bronchial asthma and heart failure.

Table 3.5 Drugs Used for Treating Glaucoma

Acute Congestive (Narrow Angle) Glaucoma	Chronic Simple (Wide-Angle) Glaucoma
Osmotic agents <ul style="list-style-type: none"> • Mannitol (20%), i.v. • Glycerol (50%), oral 	β -Blockers: Topical <ul style="list-style-type: none"> • Timolol (0.25%) • Betaxolol (0.25%) • Carteolol (1%)
Carbonic anhydrase inhibitors <ul style="list-style-type: none"> • Acetazolamide, i.v., oral 	Prostaglandins <ul style="list-style-type: none"> • Latanoprost (0.005%), topical
β -Blockers <ul style="list-style-type: none"> • Timolol (0.5%), topical 	Carbonic anhydrase inhibitors <ul style="list-style-type: none"> • Dorzolamide (2%), topical • Brinzolamide, topical • Acetazolamide, oral
Miotics <ul style="list-style-type: none"> • Pilocarpine (2%), topical 	α -Adrenergic agonists <ul style="list-style-type: none"> • Dipivefrin (0.1%), topical • Apraclonidine (1%), topical
Prostaglandins <ul style="list-style-type: none"> • Latanoprost (0.005%), topical 	Miotics <ul style="list-style-type: none"> • Pilocarpine (0.5%), topical

4. **Prostaglandins (PGs):** Topical PGs such as latanoprost and bimatoprost ($\text{PGF}_{2\alpha}$ analogues) are the preferred agents for initial therapy in open-angle glaucoma because of their longer duration of action, high efficacy and low incidence of systemic toxicity. They are also useful in acute congestive glaucoma. They reduce IOP probably by facilitating uveoscleral outflow. They usually do not cause systemic side effects, but may cause ocular irritation and iris pigmentation.
5. **Miotics:** Pilocarpine is a tertiary amine and is well absorbed through cornea. It is used topically in the treatment of open-angle and acute congestive glaucomas. It facilitates drainage of aqueous humour and reduces IOP.
6. **α -Adrenergic agonists:**
 - a. Apraclonidine is used topically as an adjunct in glaucoma. It does not cross the BBB, hence has no hypotensive effect like clonidine.

Apraclonidine \longrightarrow α_2 -Agonist \longrightarrow Reduces formation of aqueous homour \longrightarrow Decreases IOP

- b. Dipivefrin is a prodrug of adrenaline. It penetrates cornea and gets converted into adrenaline with the help of esterases.

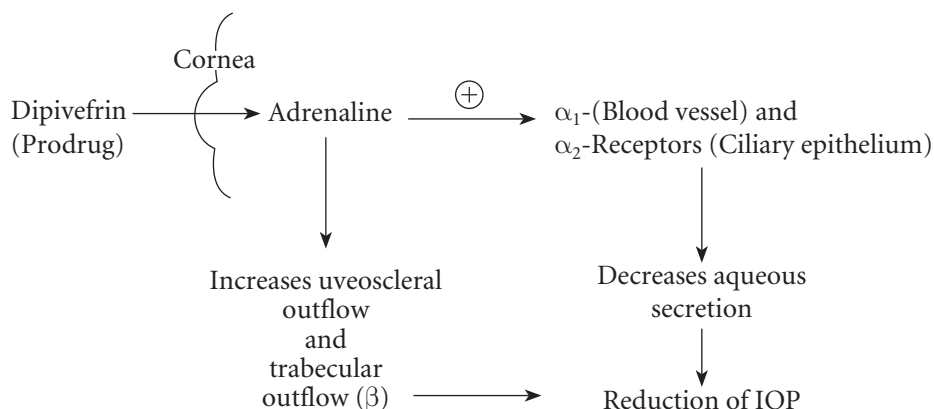

Myasthenia Gravis

It is an autoimmune disorder where antibodies are produced against N_M receptors of NMJ, resulting in a decrease in the number of N_M receptors. There is an increased incidence of myasthenia gravis in patients with thymoma. Thymectomy can induce remission in most of the cases. In myasthenia, there is marked muscular weakness varying in degree at different times. Myasthenia gravis is diagnosed by:

- Typical signs and symptoms—weakness and easy fatigability.
- Edrophonium test—slowly given i.v. edrophonium (2–10 mg) shows dramatic improvement of symptoms in patients with myasthenia gravis but not in other muscular dystrophies.
- Demonstration of circulating antibodies to N_M receptors.

Treatment

Anticholinesterases are effective in providing symptomatic relief (for mechanism of action, see p. 56, 57). Neostigmine and pyridostigmine are the commonly used anticholinesterases.

Long-term use or overdose of anticholinesterases leads to cholinergic crisis (severe muscular weakness and neuromuscular paralysis due to prolonged depolarization). This may be differentiated

from myasthenic crisis (severe weakness due to exacerbation of myasthenia) by injecting a small dose of edrophonium shown below:

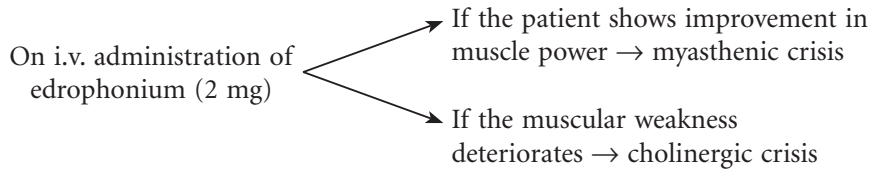

Ventilator should be kept ready before injecting edrophonium as it may aggravate cholinergic crisis, which is dangerous.

Corticosteroids and other immunosuppressants like azathioprine or cyclophosphamide are useful for the induction and maintenance of remission.

Note: Drugs that aggravate myasthenia (drugs that are contraindicated in myasthenia) are aminoglycoside antibiotics, d-tubocurarine (d-TC) and other neuromuscular blockers, β -blockers, ether, phenytoin, etc.

Postoperative Urinary Retention and Paralytic Ileus (Fig. 3.13)

Neostigmine is used because it increases the tone of the smooth muscle and relaxes the sphincters.

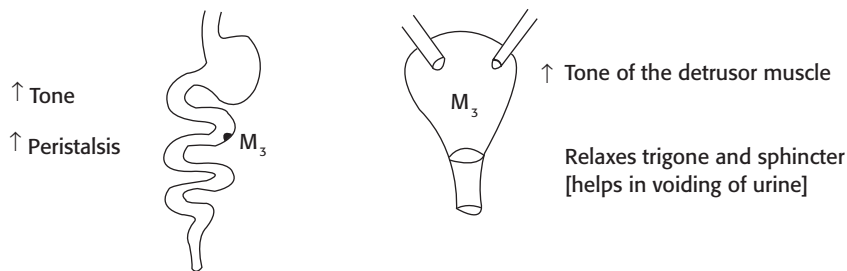

Fig. 3.13 Effects of neostigmine on smooth muscles of gut and urinary tract.

Curare Poisoning and Reversal of Nondepolarizing Neuromuscular Blockade (see p. 74).

Edrophonium or neostigmine is used. They antagonize neuromuscular blockade by increasing the concentration of ACh at NMJ. Prior administration of atropine is a must to block the muscarinic side effects.

Belladonna Poisoning (see p. 68)

Physostigmine is preferred because it reverses both central and peripheral effects of atropine poisoning.

Alzheimer's Disease

It is a degenerative disease of the cerebral cortex, characterized by progressive dementia. Donepezil, galantamine and rivastigmine are cerebrosselective anticholinesterases. They increase cerebral levels of ACh and have shown to produce some benefits in these patients.

Important **contraindications** for the use of choline esters and anticholinesterases are bronchial asthma, peptic ulcer, ischaemic heart disease and hyperthyroidism.

Mnemonic for therapeutic uses of reversible anticholinesterases

GLAUCOMA

GI atony (Paralytic ileus)

L

Alzheimer's disease

Urinary atony (Postoperative urinary retention)

Curare poisoning

Ocular conditions—glaucoma and others

Myasthenia gravis

Atropine poisoning (Belladonna poisoning)

Irreversible Anticholinesterases

Organophosphorous Insecticides

All organophosphorous (OP) compounds except echothiophate have no therapeutic applications. Echothiophate is rarely used in resistant cases of glaucoma. Organophosphorous (OP) compounds have only toxicological importance.

Organophosphorous poisoning is one of the most common poisoning all over the world. Common OP compounds are parathion, malathion, dyflos, etc. They irreversibly inhibit cholinesterases and cause accumulation of ACh at muscarinic and nicotinic sites.

Signs and symptoms

1. **Muscarinic effects:** Profuse sweating, salivation, lacrimation, increased tracheobronchial secretions, bronchospasm, vomiting, abdominal cramps, miosis, bradycardia, hypotension, involuntary urination and defecation.
2. **Nicotinic effects:** Twitchings, fasciculations, muscle weakness and paralysis is due to prolonged depolarization.
3. **Central effects:** Headache, restlessness, confusion, convulsions, coma, and death occurs usually due to respiratory failure.

Diagnosis

Organophosphorous poisoning can be diagnosed by:

- History of exposure.
- Characteristic signs and symptoms.
- Estimating the cholinesterase activity in the blood, which is decreased.

Treatment

General measures

1. Remove the contaminated clothes; wash skin with soap and water.
2. Gastric lavage should be continued till the returning fluid is clear.
3. Airway should be maintained.
4. Artificial respiration is given, if necessary.
5. Diazepam should be used cautiously by slow i.v. injection to control convulsions.

Specific measures

1. **Atropine:** Atropine is the first drug to be given in organophosphorous poisoning. Inject atropine 2 mg i.v. stat; and it should be repeated every 5–10 min doubling the dose, if required, till the patient is

fully atropinized (fully dilated, nonreactive pupils, flushed skin, tachycardia, etc.). Atropine should be continued for 7–10 days.

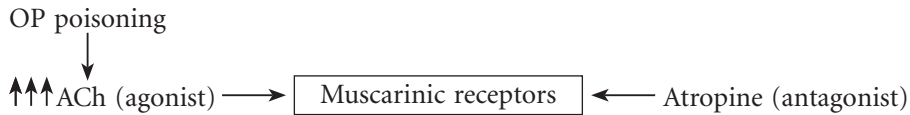

Atropine competitively blocks the muscarinic effects of organophosphorus compounds (competitive antagonism).

- Oximes:** Atropine is not effective for reversal of neuromuscular paralysis. Neuromuscular transmission can be improved by giving cholinesterase reactivators such as pralidoxime, obidoxime, etc. Pralidoxime is administered i.v. slowly in a dose of 1–2 g.

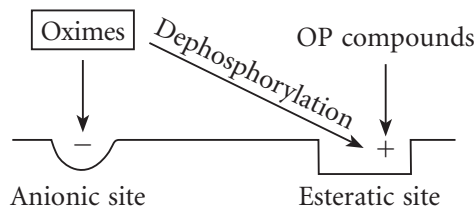

As shown above, OP compounds inactivate cholinesterases by phosphorylating esteratic site of the enzyme. Oximes bind with high affinity to anionic site and dephosphorylate the enzymes at the esteratic site, thus reactivate them. Early administration of oximes is necessary before the phosphorylated enzyme undergoes 'aging' and becomes resistant to reactivation.

Delayed toxicity of organophosphates: Prolonged exposure to organophosphorous compounds can cause neurotoxicity.

Key Points for Dentists

- Cholinergic agonists are contraindicated in bronchial asthma.
- Hypersalivation is one of the common side effects of cholinergic agonists.

ANTICHOLINERGIC AGENTS (CHOLINERGIC RECEPTOR BLOCKERS)

Anticholinergic agents block the actions of cholinergic drugs. Various anticholinergic agents are shown below.

Classification

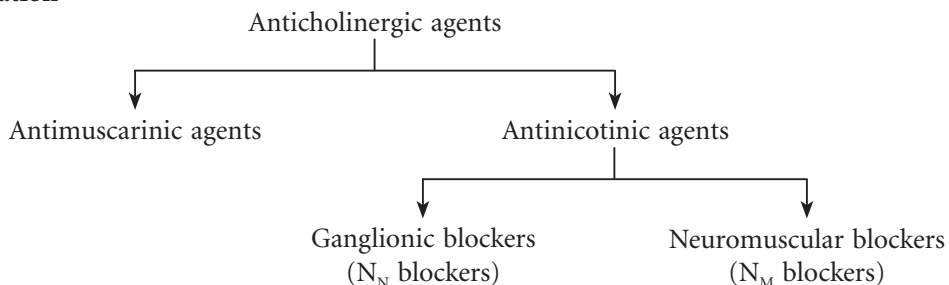

ANTIMUSCARINIC AGENTS

These drugs block muscarinic-receptor-mediated actions of acetylcholine on heart, CNS, smooth muscles and exocrine glands. Atropine and scopolamine are belladonna alkaloids. Atropine is obtained from *Atropa belladonna* and scopolamine from *Hyoscyamus niger*.

Mechanism of action



Both natural and synthetic drugs competitively block the muscarinic effects of ACh (competitive antagonism).

Classification of antimuscarinic agents

1. Natural alkaloids (*Belladonna alkaloids*): Atropine, scopolamine (hyoscine).
2. Semisynthetic and synthetic antimuscarinic agents:
 - a. Atropine derivatives used as mydriatics—homatropine, cyclopentolate, tropicamide.
 - b. Atropine derivatives used in chronic obstructive pulmonary disease (COPD) and bronchial asthma—ipratropium bromide, tiotropium bromide.
 - c. Atropine derivatives used in peptic ulcer—pirenzepine, telenzepine.
 - d. Atropine derivatives used as antispasmodics—dicyclomine, flavoxate, oxybutynin, tolterodine.
 - e. Atropine derivative used as a preanaesthetic agent—glycopyrrolate.
 - f. Atropine derivatives used in parkinsonism—benzhexol (trihexyphenidyl), benztropine, biperiden.
 - g. Atropine derivatives used in sialorrhoea—glycopyrrolate, propantheline bromide.

(Other drugs useful in sialorrhoea are atropine, scopolamine and botulinum toxin A)

■ Atropine

Atropine is the prototype drug and the chief alkaloid of belladonna. It is a tertiary amine.

■ Pharmacological Actions of Atropine (Fig. 3.14)

1. **CNS:** In therapeutic doses, atropine has mild CNS-stimulant effect. It produces antiparkinsonian effect by reducing cholinergic overactivity in basal ganglia. It suppresses vestibular disturbances and produces antimotion-sickness effect. Large doses can produce excitement, restlessness, agitation, hallucinations, medullary paralysis, coma and death.
2. **CVS:** At low doses, atropine causes initial bradycardia due to the blockade of presynaptic muscarinic autoreceptors (M_1) on vagal nerve endings. In therapeutic doses, tachycardia is seen due to blockade of M_2 receptors of the heart; it also improves A–V conduction. In high doses, flushing of the face and hypotension may occur due to cutaneous vasodilatation.
3. **Glands:** All secretions under cholinergic influence are reduced due to blockade of M_3 receptors, i.e. sweat, salivary, nasal, throat, bronchial, gastric, lacrimal, etc. The milk and bile secretions are not affected. The skin and mucous membranes become dry.
4. **Eye:** Effects of atropine on eye are depicted below (also see Table 3.6).

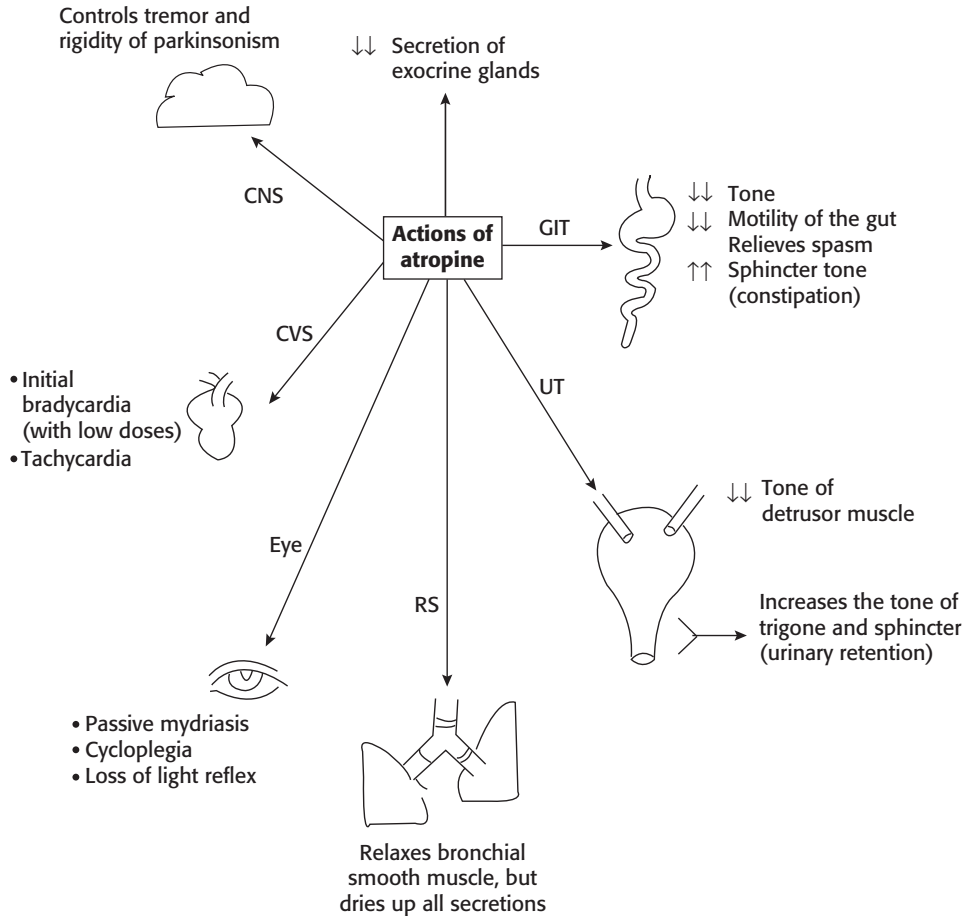
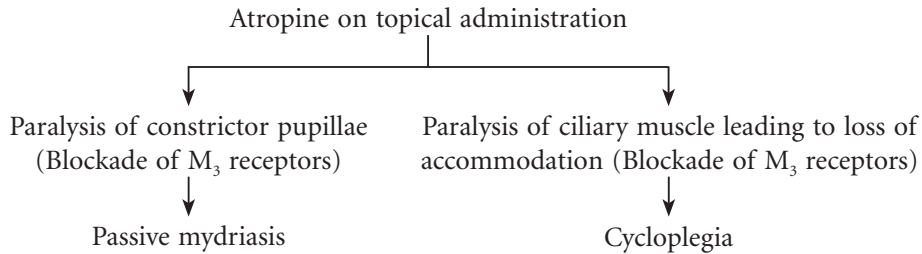

Fig. 3.14 Actions of atropine. UT, urinary tract.

Table 3.6 Effects of Atropine and Phenylephrine/Ephedrine on Eye

Atropine	Phenylephrine/Ephedrine
1. It is an anticholinergic agent - causes passive mydriasis.	1. It is a sympathomimetic agent – causes active mydriasis due to contraction of radial muscle fibres of the iris.
2. There is loss of accommodation (it is cycloplegic), photophobia and blurring of vision. Cycloplegia is due to paralysis of ciliary muscle; the lens becomes flat and vision is fixed for distant objects.	2. It does not cause cycloplegia.
3. There is loss of light reflex.	3. There is no loss of light reflex.
4. IOP may rise and acute congestive glaucoma may be precipitated in persons with shallow anterior chamber. It causes mydriasis and relaxation of ciliary muscle which occlude the canal of Schlemm, resulting in obstruction to the flow of aqueous humor.	4. IOP is reduced due to a decrease in the formation of aqueous humor.



5. Smooth muscles:

- a. **GIT:** Atropine decreases tone and motility of the gut, but increases the sphincter tone and may cause constipation. It also relaxes the smooth muscle of the gall bladder.
- b. **Urinary bladder:** Atropine relaxes the detrusor muscle of the bladder, but increases the tone of the trigonal sphincter—may cause urinary retention, especially in elderly men with enlarged prostate.
- c. **Bronchi:** Atropine relaxes the bronchial smooth muscle. It also reduces the secretion and mucociliary clearance resulting in a mucus plug that may block the airway.

Pharmacokinetics

Atropine, scopolamine and most of the synthetic tertiary amines are well absorbed from the conjunctiva and GI tract; widely distributed all over the body; cross BBB; partly metabolized in liver and partly excreted unchanged in urine.

Atropine Substitutes

These drugs are used for a selective or relatively selective action on a particular organ and to avoid undesirable effects.

1. For eye (as mydriatics)

a. *Homatropine*

- Semisynthetic atropine derivative.
- Less potent than atropine.
- Duration of action (mydriasis and cycloplegia) is 1–3 days.

b. *Cyclopentolate and tropicamide*

- Synthetic atropine derivatives with rapid onset (tropicamide is the fastest acting) and shorter duration of action than atropine.
- Action of cyclopentolate lasts for 24 hours; tropicamide is the shortest acting and action lasts for 6 hours.

2. Antispasmodics

a. *Dicyclomine*

- Tertiary amine.
- Has antispasmodic and antiemetic properties.
- Useful in dysmenorrhoea and abdominal colic.

b. *Oxybutynin*

- Has selective action at M_1 and M_3 receptors in urinary bladder and salivary gland.

- Has vesicoselective action—useful for relief of spasm after urologic surgeries, for increasing bladder capacity in paraplegics and in nocturnal enuresis.
- c. **Tolterodine**
- More selective for urinary bladder than salivary glands; hence dryness of mouth is less.
 - Used to decrease frequency and urgency in detrusor overactivity.
- d. **Flavoxate**
- Similar to oxybutynin.
 - Used to relieve urgency and frequency due to cystitis, prostatitis or urethritis.
3. **Ipratropium bromide and tiotropium bromide**
- Synthetic atropine derivatives administered by inhalation route.
 - Have a selective action on bronchial smooth muscle—bronchodilatation (mainly in the larger airways).
 - Do not affect mucociliary clearance.
 - Tiotropium (24 h) is longer acting than ipratropium (6 h).
 - Dryness of mouth is the main side effect of these agents.
4. **Pirenzepine**
- Has selective action on gastric acid secretion (M_1)—useful in peptic ulcer.
 - Anticholinergic side effects—dryness of mouth, constipation, tachycardia and urinary retention are rare.
5. **Benzhexol and bengtropine**
- They are centrally acting anticholinergic agents used in parkinsonism.
6. **Glycopyrrolate**
- Quaternary ammonium compound—central side effects are rare.
 - Used for preanaesthetic medication.

Therapeutic Uses of Atropine and Its Substitutes

1. **As mydriatic and cycloplegic:** Atropine, homatropine, cyclopentolate or tropicamide is used topically for producing mydriasis and cycloplegia during refraction testing. The action of atropine lasts 7–10 days, homatropine 1–3 days, cyclopentolate 24 h and tropicamide 6 h. Tropicamide is the preferred mydriatic for refraction testing as it has a short duration of action. In children, atropine is preferred because of its greater efficacy.
Atropinic mydriatics are used alternatively with miotics to break or prevent the adhesions between iris and lens in iridocyclitis.
2. **As preanaesthetic medication:** Atropine or glycopyrrolate is used. They are used prior to the administration of general anaesthetics:
 - To prevent vagal bradycardia during anaesthesia.
 - To prevent laryngospasm by decreasing respiratory secretions.
 Glycopyrrolate is a quaternary ammonium compound and has only peripheral anticholinergic effects.
3. **Sialorrhoea (hypersalivation): Synthetic derivatives (glycopyrrolate)** are used to decrease salivary secretion, e.g. during dental procedures and in heavy-metal poisoning. They are also useful in drooling (saliva beyond the margins of the lips).

4. **COPD and bronchial asthma:** Ipratropium bromide and tiotropium bromide are used in COPD and bronchial asthma. They are administered by metered-dose inhaler or nebulizer. They produce bronchodilatation without affecting mucociliary clearance; hence they are preferred over atropine.
5. **Anticholinergics** are useful as **antispasmodics** in dysmenorrhoea, intestinal and renal colic.
6. **Urinary disorders:** Oxybutynin and flavoxate have more prominent effect on bladder smooth muscle and hence are used to relieve spasm after urologic surgery. Tolterodine, an atropine substitute, has selective action on bladder smooth muscle (M_3); hence, it is used to relieve urinary incontinence.
7. **Poisoning:**
 - a. In organophosphorous poisoning, atropine is the life-saving drug (see p. 62–63).
 - b. In some types of mushroom poisoning (*Inocybe species*), atropine is the drug of choice .
 - c. Atropine is used in curare poisoning with neostigmine to counteract the muscarinic effects of neostigmine.
8. **As vagolytic:** Atropine is used to treat sinus bradycardia and partial heart block due to increased vagal activity. It improves A–V conduction by vagolytic effect.
9. **Parkinsonism:** Centrally acting anticholinergic drugs such as benzhexol (trihexyphenidyl), benztropine, biperiden, etc. are the preferred agents for prevention and treatment of drug-induced parkinsonism. They are also useful in idiopathic parkinsonism, but less effective than levodopa. They control tremor and rigidity of parkinsonism.

Adverse Effects and Contraindications

Adverse effects are due to the extension of pharmacological actions.

1. **GIT:** Dryness of mouth and throat, difficulty in swallowing, constipation, etc.
2. **Eye:** Photophobia, headache, blurring of vision; in elderly persons with shallow anterior chamber, they may precipitate acute congestive glaucoma.
3. **Urinary tract:** Difficulty in micturition and urinary retention, especially in elderly men with enlarged prostate. So, they are contraindicated in these patients.
4. **CNS:** With large doses produce restlessness, excitement, delirium and hallucinations.
5. **CVS:** Tachycardia, palpitation and hypotension.
6. **Acute belladonna poisoning:** It is more common in children. It is characterised by increased body temperature (hyperpyrexia), dry flushed skin, photophobia and blurring of vision, restlessness, confusion, disorientation, etc.

Severe poisoning may cause respiratory depression, cardiovascular collapse, convulsions, coma and death.

Treatment of belladonna poisoning (atropine poisoning): It is mainly symptomatic.

1. Hospitalization.
2. Gastric lavage in case of ingested poison.
2. Tepid sponging to control hyperpyrexia.
3. Diazepam to control convulsions.
4. The antidote for severe atropine poisoning is physostigmine (1–4 mg). It is injected intravenously slowly. It is a tertiary amine—counteracts both peripheral as well as central effects of atropine poisoning. Hence, physostigmine is preferred over neostigmine.

■ Scopolamine

Scopolamine (hyoscine), another belladonna alkaloid, produces all the actions of atropine. In therapeutic doses, it produces prominent CNS depression with sedation and amnesia. Scopolamine has shorter duration of action than atropine. It has more prominent actions on eyes and secretory glands. By blocking cholinergic activity, scopolamine suppresses vestibular disturbances and prevents motion sickness (Fig. 3.15). It is the drug of choice for motion sickness—can be administered orally or as a transdermal patch. It is more effective for prevention of motion sickness; hence it should be given (0.2 mg oral) at least half-an-hour before journey. The patch is placed behind the ear over the mastoid process. The patch should be used at least 4–5 h before the journey, and its effect lasts 72 h. Scopolamine may cause sedation and dryness of mouth.

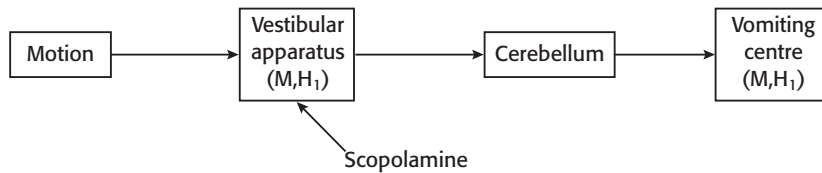

Fig. 3.15 Site of action of scopolamine in motion sickness. M, muscarinic receptor; H, histamine receptor.

Drug interactions

- H_1 -blockers, tricyclic antidepressants (TCAs), phenothiazines, etc. have atropine-like actions; hence, they may potentiate anticholinergic side effects.
- Atropine alters the absorption of some of the drugs by delaying gastric emptying—the bioavailability of levodopa is reduced, whereas the absorption of tetracyclines and digoxin is enhanced due to increased GI transit time.

GANGLIONIC BLOCKERS

They act at N_N receptors of the autonomic ganglia (block both parasympathetic and sympathetic ganglia) and produce widespread complex effects (Fig. 3.16).

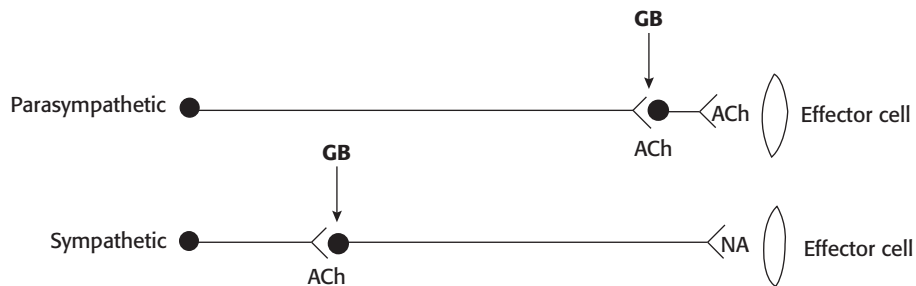

Fig. 3.16 Site of action of ganglion blockers (GBs).

The ganglionic blockers have 'atropine-like' action on heart (palpitation and tachycardia), eye (mydriasis and cycloplegia), GIT (dryness of mouth and constipation), bladder (urinary retention), impotence in males and decreased sweat secretion. Blockade of sympathetic ganglia results in marked postural hypotension.

No selective ganglion blockers are available till now. Hence, they are rarely used in therapy.

Nicotine is obtained from tobacco leaves. It has initial stimulating and later a prolonged blocking effect on the autonomic ganglia. Tobacco smoking and chewing is a serious risk factor for oral, lung, heart and other diseases. Nicotine is of no value in clinical practice except in the form of transdermal patch and chewing gum for the treatment of tobacco addiction.

Key Points for Dentists

- **Drugs causing dry mouth (Xerostomia):** All anticholinergic agents, tricyclic antidepressants, phenothiazines, first-generation H₁ blockers—due to their anticholinergic action; clonidine—central sympatholytic agent.
- Patient on anticholinergics should be advised to maintain good oral hygiene.
- Anticholinergic drugs should not be used in patients with glaucoma and elderly males with enlarged prostate.

SKELETAL MUSCLE RELAXANTS

The skeletal muscle relaxants decrease skeletal muscle tone by peripheral or central action.

Physiology of skeletal muscle contraction

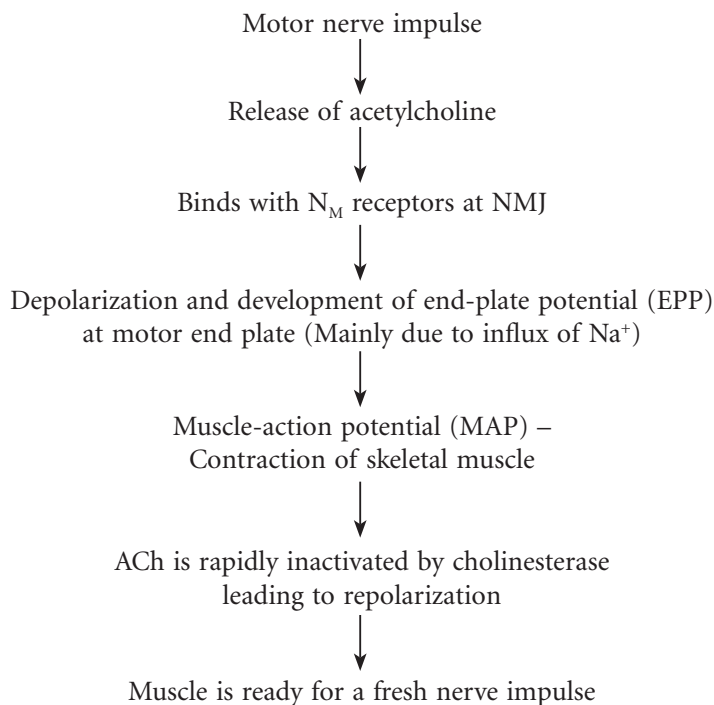

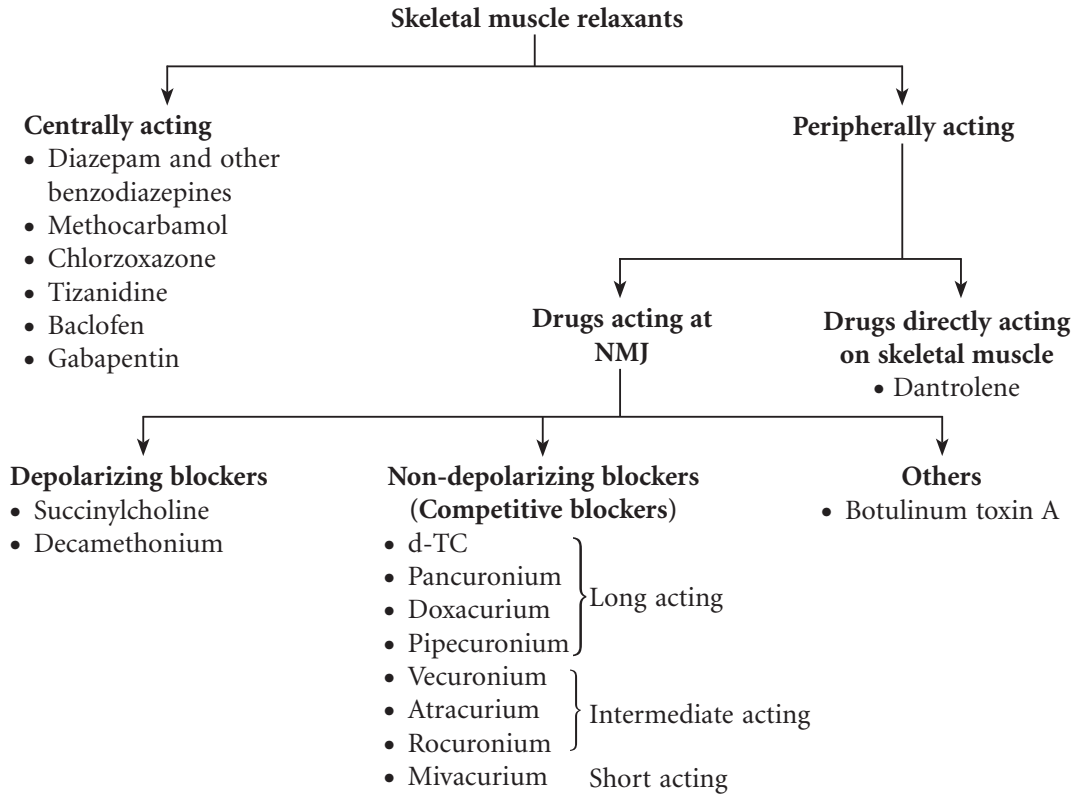
Classification**Centrally Acting Skeletal Muscle Relaxants**

They are baclofen, diazepam and other benzodiazepines, tizanidine, chlorzoxazone, methocarbamol, etc. All are effective orally. Baclofen and benzodiazepines can also be administered parenterally. They are used to reduce spasm associated with temporomandibular joint pain, cerebral palsy, trauma, muscular strain, tetanus, etc.

Neuromuscular Blockers

Neuromuscular blockers include non-depolarizing (competitive) and depolarizing blockers.

Depolarizing Blockers (Table 3.7): Succinylcholine

Succinylcholine is a quaternary ammonium compound. The structure resembles two molecules of ACh linked together. It acts as a partial agonist at N_M receptors, hence causes initial fasciculations and later flaccid paralysis due to prolonged depolarization (phase I block). With continued exposure to the drug, the membrane becomes desensitized; this leads to phase II block, which resembles the non-depolarizing block and is partially reversed by anticholinesterases.

Table 3.7 Features of Non-depolarizing and Depolarizing Blockers

Non-depolarizing Blockers	Depolarizing Blockers
<ol style="list-style-type: none"> 1. d-TC: An alkaloid obtained from <i>Chondrodendron tomentosum</i> <ul style="list-style-type: none"> • Prototype competitive blocker • Causes histamine release, ganglionic blockade • Duration of action—80 min 2. Pancuronium <ul style="list-style-type: none"> • Synthetic agent • Produces competitive blockade • Has longer duration of action • Minimal/no histamine release • Has vagolytic action; hence it causes tachycardia 3. Doxacurium <ul style="list-style-type: none"> • Non-depolarizing blocker • Minimal histamine release • Has long duration of action • Mainly excreted in urine 4. Vecuronium <ul style="list-style-type: none"> • One of the commonly used neuromuscular blocker • Has intermediate duration of action • Minimal/no tendency to release histamine or cause cardiovascular effects • Does not cross the placental barrier 5. Atracurium <ul style="list-style-type: none"> • Has intermediate duration of action • Undergoes spontaneous degradation in plasma (Hofmann degradation) in addition to destruction by cholinesterases • Causes histamine release • Safe in patients with hepatic and renal dysfunction 6. Mivacurium <ul style="list-style-type: none"> • Has short duration of action (15–20 min) • Rapidly inactivated by plasma cholinesterases • Does not require reversal • Causes histamine release • Duration of action is prolonged in patients with pseudocholinesterase deficiency 7. Rocuronium <ul style="list-style-type: none"> • Has intermediate duration of action • Minimal/no tendency to release histamine • Has a rapid onset of action 	<ol style="list-style-type: none"> 1. Succinylcholine <ul style="list-style-type: none"> • Synthetic, shortest-acting (3–8 min) neuromuscular blocker • Initially causes fasciculation and later flaccid paralysis • Can cause histamine release

Succinylcholine is rapidly hydrolysed by pseudocholinesterase, hence has a very short duration of action (3–8 min). Transient apnoea is usually seen at the peak of its action. In people with liver disease or atypical pseudocholinesterase due to genetic defect, the metabolism of succinylcholine becomes slow; this results in severe neuromuscular blockade leading to respiratory paralysis with prolonged apnoea. This is referred to as '*succinylcholine apnoea*'. There is no antidote available, therefore:

- Fresh frozen plasma should be infused.
- Patient should be ventilated artificially until full recovery.

Adverse effects

1. Muscle pain is due to initial fasciculations (muscle soreness).
2. Increased IOP due to contraction of external ocular muscles; and it lasts for few minutes.
3. Aspiration of gastric contents may occur due to increased intragastric pressure.
4. Hyperkalaemia—fasciculations release K^+ into the blood.
5. Sinus bradycardia is due to vagal stimulation.
6. Succinylcholine apnoea (prolonged apnoea).
7. Malignant hyperthermia, especially when used with halothane in genetically susceptible individuals. This is treated with intravenous dantrolene, rapid cooling, inhalation of 100% oxygen and control of acidosis.

Competitive Blockers (Non-depolarizing Blockers) (Table 3.7)

Claude Bernard experimentally showed the site of action of curare. Curare is a mixture of alkaloids and was used as arrow poison. Among them, d-TC is the most important alkaloid, which has N_M -blocking activity. d-TC is the prototype drug of competitive blockers.

Mechanism of Action

Acetylcholine is the agonist, whereas d-TC is the antagonist at N_M receptors. Curariform drugs competitively antagonise the actions of ACh at the N_M receptors of the NMJ. Anticholinesterases (neostigmine or edrophonium) are used to reverse the effects of competitive blockers by increasing the concentration of ACh.

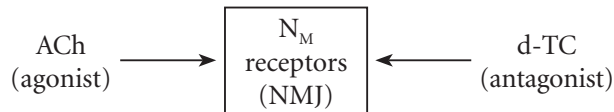

Actions

Competitive blockers produce flaccid paralysis. The order of muscles affected is extrinsic eye muscles—neck (muscles of phonation and swallowing)—face—hands—feet—limbs—trunk and finally, the respiratory muscles (intercostal muscles and the diaphragm). But recovery occurs in reverse order—the respiratory muscles are the first to recover. Consciousness and appreciation of pain are not affected.

- d-TC, mivacurium and atracurium causes histamine release; this can manifest as hypotension, bronchospasm, etc.
- Pancuronium, vecuronium, doxacurium and rocuronium have minimal/no tendency to cause histamine release.
- Vecuronium, doxacurium and rocuronium have minimal tendency to cause cardiovascular effects like hypotension, cardiovascular collapse, etc. These effects are prominent with d-TC, pancuronium, atracurium and mivacurium.
- Among competitive neuromuscular blockers, rocuronium has a rapid onset of action.

Pharmacokinetics

Neuromuscular blockers are quaternary ammonium compounds. They are highly ionized, hence are poorly absorbed from GI tract. They are administered intravenously. They are mainly confined to ECF

space and do not cross placental and blood–brain barrier. They are metabolized in liver and some are excreted unchanged in urine.

Adverse Effects

The adverse effects of non-depolarizing drugs are hypotension, respiratory paralysis, bronchospasm and aspiration of gastric contents.

Factors Affecting the Action of Neuromuscular Blockers

1. **pH changes:** Metabolic acidosis and respiratory acidosis increase the duration of block.
2. **Hypothermia:** It potentiates the neuromuscular block by delaying the metabolism and elimination of these drugs.
3. **Myasthenia gravis:** Myasthenic patients are highly sensitive to competitive neuromuscular blockers.
4. **Aminoglycoside antibiotics:** They potentiate the effect of both competitive as well as non-depolarizing blockers by inhibiting the presynaptic release of ACh.
5. **Inhalational anaesthetics:** Anaesthetics like ether, halothane, isoflurane, etc. increase the effects of neuromuscular-blocking agents.

Uses

1. The main use of neuromuscular blockers is as adjuvant to general anaesthesia for producing satisfactory skeletal muscle relaxation during surgical procedures. Succinylcholine is preferred for short procedures, e.g. diagnostic endoscopies, endotracheal intubation, orthopaedic manipulations, etc.
2. In dentistry: Muscle relaxants are useful to allow manipulation of bone fragments in *fracture of mandible* and to facilitate opening of the mouth for diagnosis and treatment in *trismus*.
3. Succinylcholine is used during electroconvulsive therapy (ECT) of psychiatric disorders to prevent trauma due to convulsions.
4. Tetanus and status epilepticus not controlled by other drugs.
5. Competitive neuromuscular blockers can be used for ventilatory support in critically ill patients.

Reversal of Action of Competitive Neuromuscular Blockers

Edrophonium or neostigmine by increasing the concentration of ACh reverses the effect of d-TC and other competitive blockers at NMJ. Prior atropine administration is necessary to block the muscarinic effects of anticholinesterases (Fig. 3.17). Mivacurium (short acting), atracurium (intermediate acting), etc. do not require reversal.

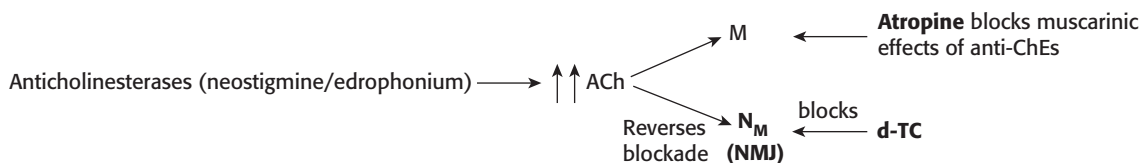

Fig. 3.17 Reversal of neuromuscular blockade. ACh: acetylcholine; NMJ, neuromuscular junction; N_M: nicotinic receptor; M: muscarinic receptor.

Botulinum Toxin A

It is obtained from *Clostridium botulinum*, a gram-positive anaerobic bacterium, which causes a serious form of food poisoning called botulism. The toxin prevents the release of ACh into the synaptic cleft by inhibiting the proteins necessary for the release of ACh. Thus, it normalises the tone in hyperreactive or spastic muscles when given locally. It is given intradermally for antiwrinkle effect in cosmetic procedures and into the muscle in multiple doses for spasticity or dystonia. Botulinum toxin A is injected under ultrasound guidance into salivary glands in sialorrhoea and drooling. Adverse effects are pain at the site of injection, muscle paralysis, myalgia and occasionally rashes.

Directly Acting Drug: Dantrolene

Dantrolene is a directly acting skeletal muscle relaxant. It inhibits depolarization-induced Ca^{2+} release from the sarcoplasmic reticulum and produces skeletal muscle relaxation. Intravenous dantrolene is the life-saving drug in malignant hyperthermia. It is used orally to reduce spasm in multiple sclerosis, cerebral palsy, spinal injuries, etc. The side effects are drowsiness, diarrhoea, dizziness, headache, fatigue and rarely hepatotoxicity.

Key Points for Dentists

- Succinylcholine may cause muscle pain.
- Skeletal muscle relaxants are contraindicated in patients with myasthenia gravis.
- Aminoglycosides potentiate the effect of neuromuscular blockers.

ADRENERGIC AGONISTS (SYMPATHOMIMETIC AGENTS)

Adrenergic agonists mimic the actions of sympathetic stimulation.

Adrenergic Transmission

The transmitter in the sympathetic system is noradrenaline (NA; norepinephrine). Nerves that synthesize, store and release NA are called adrenergic (sympathetic) nerves.

Synthesis of catecholamines begins with the amino acid tyrosine, which is transported into the adrenergic neuron by active transport. In the neuronal cytosol, tyrosine is converted to DOPA by tyrosine hydroxylase and DOPA to dopamine (DA) by DOPA decarboxylase. Dopamine enters the storage vesicles of the nerve terminal by active transport, where it is converted to NA by the enzyme dopamine β -hydroxylase (this enzyme is present only in the storage vesicles); the NA formed gets stored in the vesicles. In the adrenal medulla, NA is further converted to adrenaline by *N*-methyltransferase. Small quantities of NA are released continuously into the synaptic cleft and large quantities during nerve stimulation (Fig. 3.18).

Three processes are involved in the termination of action of released NA in the synaptic cleft (fate of released NA in the synaptic cleft):

1. Most of the released NA is taken back into the adrenergic nerve terminals (neuronal reuptake), which is either stored in the vesicles or inactivated by mitochondrial monoamine oxidase (MAO) in the cytosol. Neuronal reuptake is the most important mechanism through which the termination of action of NA takes place in the synaptic cleft.

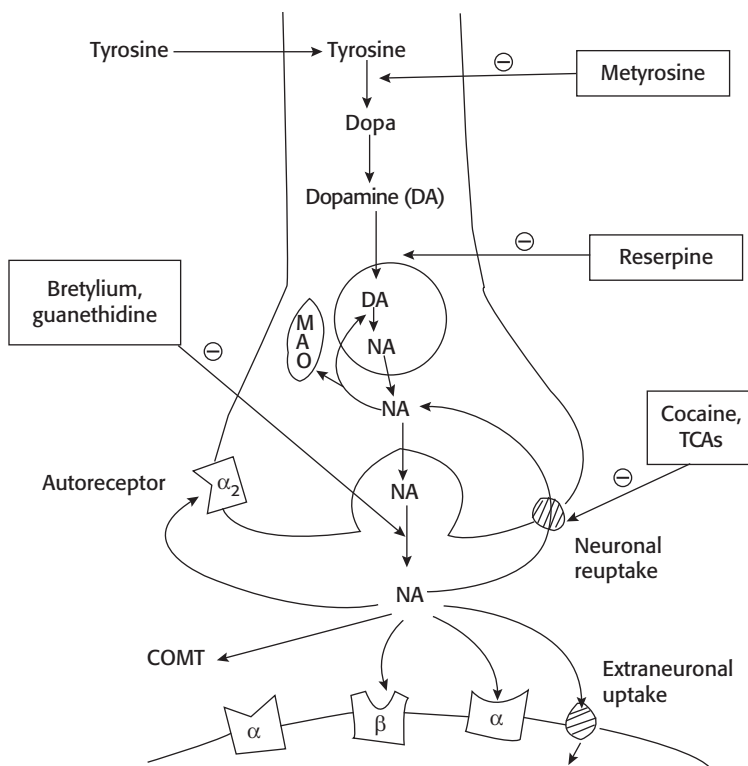

Fig. 3.18 Synthesis and release of NA from the adrenergic neuron and various drugs affecting the pathway (Table 3.8). MAO, monoamine oxidase; COMT, catechol-O-methyltransferase; TCAs, tricyclic antidepressants.

Table 3.8 Drugs Affecting Adrenergic Transmission and Their Uses

Drug	Action	Response/Therapeutic Uses
Metyrosine (α -methyl tyrosine)	Inhibits tyrosine hydroxylase enzyme	Blocks the synthesis of NA—useful in the treatment of selected cases of pheochromocytoma
α -Methyldopa	Replacement of NA by false transmitter (α -methyl-NA)	α -Methyl NA is an α_2 -agonist, used in hypertension especially in pregnancy
Reserpine	Blocks vesicular uptake and storage of NA	Depletion of NA; destruction by mitochondrial MAO: used in hypertension
Cocaine, TCAs	Inhibit neuronal reuptake of NA (uptake-1)	Accumulation of NA at receptors
Adrenergic agonists	Mimic the effects of neurotransmitter at receptor	Sympathomimetic effects
Tyramine, ephedrine, amphetamine	Promote the release of NA from adrenergic nerve terminals	Tyramine, amphetamine (indirectly acting) and ephedrine (mixed acting) sympathomimetics
Adrenergic antagonists	Block the effects of neurotransmitter at receptors	For uses see p. 91, 94-95

- Small amount of NA from the synaptic cleft diffuses into circulation and gets inactivated in liver by catechol-*O*-methyltransferase (COMT) and MAO.
- Small quantity of NA is transported into other tissues (extraneuronal uptake).

Metabolism of Catecholamines

The main metabolite of catecholamines is vanillylmandelic acid (VMA). It is excreted in urine.

Types, Distribution and Functions of Adrenergic Receptors

Ahlquist divided adrenergic receptors into α and β types, which are located on the cell membrane. They are further divided into various subtypes, which are as follows:

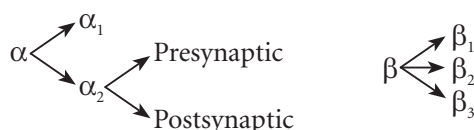

Distribution of various adrenergic receptors is indicated in Figure 3.19.

- Effect of activation of α_1 -receptors**
 - Blood vessels:** Constriction.
 - GI sphincter (anal):** Increase in tone.
 - Urinary sphincter:** Increase in tone.
 - Radial muscle (iris):** Contraction (mydriasis).
- Effect of activation of presynaptic α_2 -receptors**
 - Mediate negative-feedback control on NA secretion (i.e. stimulation of α_2 -receptors decreases the release of NA from sympathetic nerve endings).
- Effect of activation of postsynaptic vascular α_2 -receptors**
 - Mediate stimulatory effects: Vasoconstriction and venoconstriction.
- Effect of activation of α_2 -receptors on various secretions**
 - Beta cells of islets of Langerhans in pancreas:** Decrease in insulin secretion.
 - Ciliary epithelium:** Reduction of aqueous humor secretion.
 - Sympathetic nerve endings:** Decrease in NA release.
- Effect of activation of β_1 -receptors**
 - Heart:** Cardiac stimulation.
 - Kidney:** Promote renin release.
- Stimulatory effects due to activation of β_2 -receptors**
 - Liver:** Stimulation of glycogenolysis.
 - Skeletal muscle:** Contraction.
 - Ciliary epithelium:** Increase in secretion of aqueous humor.
 - Uptake of K^+ into cells.
- Inhibitory effects due to activation of β_2 -receptors**
 - Bronchial, uterine (pregnant), vascular, bladder smooth muscles:** Relaxation.
 - In GI smooth muscle, activation of both α and β receptors cause relaxation.
- Effect of activation of β_3 -receptors**
 - Adipose tissue:** Lipolysis.

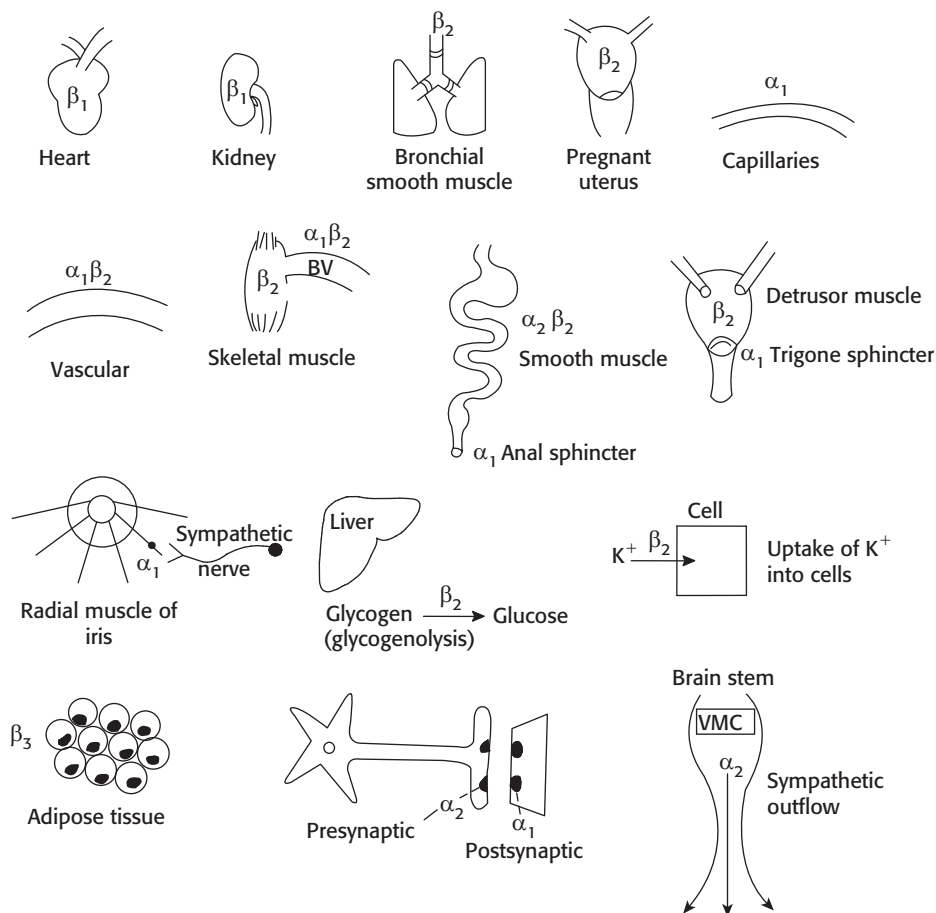

Fig. 3.19 Distribution of various adrenergic receptors. VMC, vasomotor centre; BV, blood vessel.

■ Adrenergic Drugs (Sympathomimetics)

The sympathomimetic drugs mimic the effects of sympathetic nerve stimulation (Fig. 3.20). They are also referred to as adrenergic agonists.

■ Classification of Sympathomimetics

1. On the basis of their chemical structure

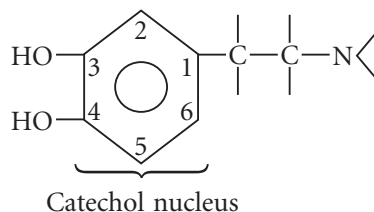

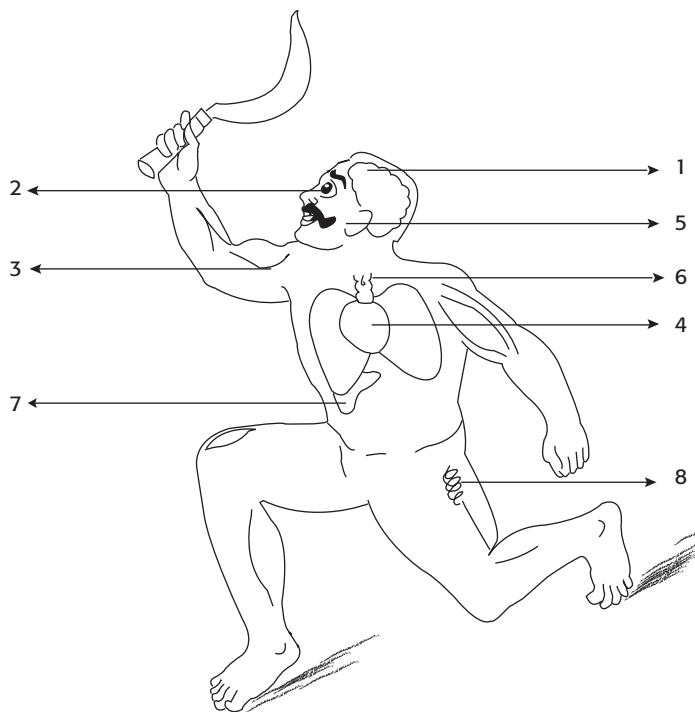

Fig. 3.20 An angry man symbolizing sympathetic overactivity (Fight–Fright–Flight)—1: Anger, alert, aggressive; 2: Pupillary dilatation (mydriasis); 3: Increased muscle tone, tremors; 4: Palpitation–increased cardiac output–increased blood flow to the skeletal muscles; 5: Flushing of the face; 6: Tachypnoea, bronchodilatation; 7: Liver–glycogenolysis–more energy; 8: Adipose tissue–lipolysis–energy.

- a. **Catecholamines:** Sympathomimetics with catechol nucleus are called catecholamines, e.g. adrenaline, noradrenaline, dopamine, dobutamine, isoprenaline.
 - b. **Non-catecholamines:** Sympathomimetics that lack catechol nucleus are called non-catecholamines, e.g. tyramine, ephedrine, amphetamine, phenylephrine, salbutamol, etc.
2. **On the basis of their mechanism of action** (Table 3.9):
 - a. **Direct acting:** They act directly by stimulating adrenergic receptors.
 - b. **Indirect acting:** They act by releasing NA from adrenergic nerve endings.
 - c. **Mixed acting:** These drugs act both directly and indirectly.
 3. **On the basis of their therapeutic use:**
 - a. **To raise the blood pressure in shock:** Dopamine, noradrenaline, ephedrine, phenylephrine, methoxamine, mephentermine.
 - b. **As bronchodilator:** Salbutamol, terbutaline, salmeterol, formoterol.
 - c. **As cardiac stimulant:** Adrenaline, isoprenaline, dobutamine.
 - d. **As CNS stimulant:** Amphetamine, dextroamphetamine.
 - e. **For local vasoconstrictor effect:** Adrenaline.

Table 3.9 Summary of Sympathomimetic Agents

Adrenergic Agonists	Receptor Action	Therapeutic Uses
1. Directly acting		
<ul style="list-style-type: none"> Adrenaline 	α_1 -, α_2 -, β_1 -, β_2 - and β_3 -agonist	Anaphylactic shock, Bronchial asthma (acute), Cardiac arrest, to prolong the Duration of local anaesthesia, to control Epistaxis and other capillary oozing (ABCDE)
<ul style="list-style-type: none"> Noradrenaline 	α_1 -, α_2 - and β_1 -agonist	Hypotensive states
<ul style="list-style-type: none"> Isoprenaline 	β_1 - and β_2 -agonist	Heart block, cardiac arrest
<ul style="list-style-type: none"> Dobutamine 	Relatively selective β_1 -agonist	Cardiogenic shock due to acute myocardial infarction (MI), congestive cardiac failure (CCF) or cardiac surgery
<ul style="list-style-type: none"> Salbutamol (Albuterol) Terbutaline Salmeterol Formoterol 	Selective β_2 -agonists	Bronchial asthma, to suppress premature labour (as uterine relaxant)
<ul style="list-style-type: none"> Phenylephrine Methoxamine 	Selective α_1 -agonists	Vasopressor agents, nasal decongestants, as mydriatic (phenylephrine), allergic or vasomotor rhinitis
<ul style="list-style-type: none"> Naphazoline Oxymetazoline Xylometazoline 	α_1 + α_2 -agonists	Nasal decongestants (α_1 -stimulation), Structural damage can occur due to intense vasoconstriction (α_2 -stimulation)
<ul style="list-style-type: none"> Clonidine, α-Methyldopa 	α_2 -agonists	Hypertension
<ul style="list-style-type: none"> Apraclonidine Brimonidine 	α_2 -agonists	Glaucoma (topical)
2. Indirectly acting		
<ul style="list-style-type: none"> Amphetamine Methamphetamine Methylphenidate 	They act by releasing NA in the periphery; NA, DA and 5-hydroxytryptamine (5-HT) centrally	Narcolepsy, attention-deficit hyperkinetic disorder (ADHD)
3. Mixed acting		
<ul style="list-style-type: none"> Ephedrine 	α_1 , α_2 , β_1 and β_2 (direct action) + releases NA (indirect action)	Intravenous ephedrine is used for the treatment of hypotension due to spinal anaesthesia
<ul style="list-style-type: none"> Dopamine 	α_1 , α_2 , β_1 and D_1 + releases NA	Cardiogenic shock, CCF with oliguria

f. *As nasal decongestant*: Phenylephrine, xylometazoline, pseudoephedrine, oxymetazoline, naphazoline.

g. *For allergic reactions (anaphylactic shock)*: Adrenaline.

h. *As anorexiant*: Dextroamphetamine, mazindol, phentermine, sibutramine.

■ Direct-acting Sympathomimetics

▶ Adrenaline (Epinephrine): α_1 -, α_2 -, β_1 -, β_2 - and β_3 -Agonist

It is a catecholamine, which is secreted mainly by adrenal medulla. Adrenaline is a direct acting nonselective adrenergic agonist.

Pharmacological actions

Adrenaline acts on α_1 -, α_2 -, β_1 -, β_2 - and β_3 -receptors.

1. Cardiovascular system

- a. **Heart:** Adrenaline is a powerful cardiac stimulant. It acts mainly by interacting with β_1 -receptors and produces various effects. They are as follows:
 - i. Increase in heart rate (positive chronotropic effect).
 - ii. Increase in myocardial contractility (positive inotropic effect).
 - iii. Increase in conduction velocity (positive dromotropic effect).
 - iv. Increase in cardiac output.
 - v. Increase in automaticity.
 - vi. Cardiac work and its oxygen requirement is markedly increased.
 - vii. Increase in the excitability and tendency to cause cardiac arrhythmias.
- b. **Blood vessels and BP:** Blood vessels of the skin and mucous membranes (α_1 -receptors) are constricted by adrenaline. It also constricts renal, mesenteric, pulmonary and splanchnic vessels, but dilates the blood vessels of skeletal muscle and coronary vessels (β_2). Intravenous administration of adrenaline in moderate doses produces biphasic effect. There is an initial rise in BP due to α_1 (blood vessels) and β_1 (heart) actions, followed by a fall in BP due to β_2 -mediated vasodilatation in skeletal muscle. Administration of adrenaline after α -blocker produces only a fall in BP (β_2 -action). This is referred to as vasomotor reversal.

2. **Respiratory system:** Adrenaline rapidly relaxes (β_2) bronchial smooth muscle. It is a potent bronchodilator but has a short duration of action. It inhibits the release of inflammatory mediators from mast cells (β_2). It also reduces secretions and relieves mucosal congestion by vasoconstrictor effect (α_1).

3. **GIT:** It relaxes the smooth muscle of the gut (α_2 and β_2). It reduces the intestinal tone and peristaltic movements. But the effects are transient.

4. **Bladder:** It relaxes the detrusor muscle (β_2) and contracts the sphincter (α_1). As a result, it may cause difficulty in urination.

5. **CNS:** In therapeutic doses, adrenaline does not cross the BBB and hence CNS effects are very minimal. But in high doses, it may cause headache, restlessness and tremor.

6. **Eye:** Adrenaline has poor penetration through cornea when applied topically into the eye. Hence, it is administered as a prodrug (see p. 60).

7. Metabolic effects:

Adrenaline increases the blood glucose level by:

- i. Stimulating hepatic glycogenolysis (β_2), which is the predominant effect.
- ii. Reducing insulin secretion.
- iii. Decreasing the uptake of glucose by peripheral tissues.

8. Other effects

It reduces plasma K^+ levels by promoting the uptake of K^+ into the cells, particularly into the skeletal muscle (β_2).

Pharmacokinetics

Adrenaline is not suitable for oral administration because of its rapid inactivation in the GI mucosa and liver. Adrenaline can be given subcutaneously (s.c.). In anaphylactic shock, the absorption of s.c. adrenaline is very poor, hence given intramuscularly. In cardiac arrest, it is given intravenously. It does not cross the BBB; is rapidly metabolized by COMT and MAO and the metabolites are excreted in urine.

Adverse effects and contraindications

The adverse effects of adrenaline are due to extension of its pharmacological actions. They are tachycardia, palpitation, headache, restlessness, tremor and rise in BP. The serious side effects are cerebral haemorrhage and cardiac arrhythmias. In high concentration, adrenaline may cause acute pulmonary oedema due to shift of blood from systemic to pulmonary circulation. Adrenaline is contraindicated in most of the cardiovascular diseases such as hypertension, angina, cardiac arrhythmias, CCF, etc. It should also be avoided in patients on β -blockers because it may cause hypertensive crisis and cerebral haemorrhage due to unopposed action on vascular α_1 -receptors.

Therapeutic uses of adrenaline (ABCDE)

1. **Anaphylactic shock:** Adrenaline is the life-saving drug in anaphylactic shock. Adrenaline 0.3–0.5 mL of 1:1000 solution (1 mg/mL) is administered intramuscularly. It rapidly reverses the manifestations of severe allergic reactions (see p. 30, 37).
2. **Bronchial asthma:** Adrenaline is a powerful bronchodilator and has rapid onset but short duration of action. It is useful for acute attack. Its use has declined because of its dangerous cardiac-stimulant effect. The beneficial effects of adrenaline in bronchial asthma are shown in Figure 3.21. Adrenaline 0.3–0.5 mL of 1:1000 solution is given subcutaneously. It can be given by nebulization (as inhalation).
3. **Cardiac resuscitation:** In the treatment of cardiac arrest due to drowning or electrocution, adrenaline is injected intravenously in 1:10000 (0.1 mg/mL) concentration along with other supportive measures such as external cardiac massage, as a part of advanced life support (ALS).
4. **Prolongs the Duration of local anaesthesia:** Adrenaline (1:1,00,000) with lignocaine. Adrenaline, by its vasoconstrictor effect (α_1) delays absorption of local anaesthetic and prolongs the duration of local anaesthesia (see p. 159).

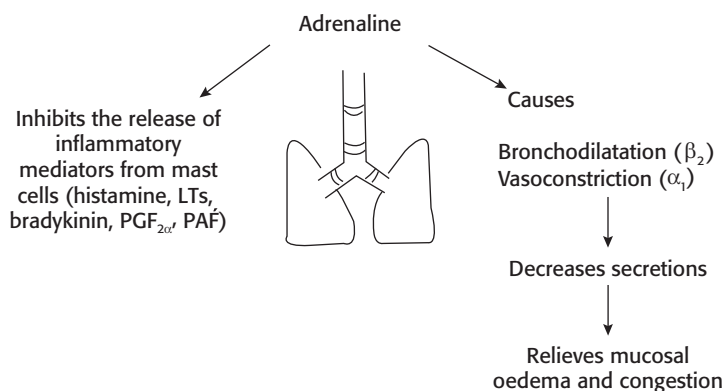

Fig. 3.21 Effects of adrenaline in bronchial asthma: LTs, leukotrienes; $\text{PGF}_{2\alpha}$, prostaglandin $\text{F}_{2\alpha}$; PAF, platelet activating factor.

5. **Controls Epistaxis and other capillary oozing:** Adrenaline is used as a local haemostatic to control bleeding following tooth extraction and during surgical procedures in nose, throat, larynx, etc. because of its vasoconstrictor effect.
6. **Glaucoma:** Adrenaline has poor penetration when applied locally into the eye; hence it is administered as a prodrug (see p. 60).

▮ Noradrenaline: α_1 -, α_2 - and β_1 -Agonist (Table 3.10)

Noradrenaline is a catecholamine. It is the main neurotransmitter in adrenergic system. It acts on α_1 -, α_2 - and β_1 -adrenergic receptors; has negligible β_2 action. The main action of NA is on cardiovascular system. It has a direct cardiac-stimulant effect (β_1); also constricts all the blood vessels (α_1) including those of the skin, mucous membrane, renal, mesenteric, pulmonary, skeletal muscle, etc. So the systolic, diastolic and pulse pressures are increased. There is reflex bradycardia. Noradrenaline, like adrenaline, is not effective orally. It is not suitable for s.c., i.m. or direct i.v. infusion because of necrosis and sloughing of the tissues at the site of injection. It is administered by i.v. infusion. It can be used to raise BP in hypotensive states; but it may decrease blood flow to vital organs by causing widespread vasoconstriction.

▮ Isoprenaline (Isoproterenol): β_1 -, β_2 - and β_3 -Agonist

It is a synthetic, nonselective β -receptor agonist with a catechol nucleus. It has potent β actions ($\beta_1 + \beta_2$) but no action at α -receptors. Isoprenaline is a powerful cardiac stimulant. It has positive inotropic, chronotropic and dromotropic effects. It dilates renal, mesenteric and skeletal muscle blood vessels. Systolic BP is minimally changed but the diastolic and mean arterial pressures are reduced. It relaxes bronchial and GI smooth muscles. Isoprenaline is not effective orally because of extensive first-pass metabolism. It can be given parenterally or as an aerosol. It is metabolized by COMT. Isoprenaline

Table 3.10 Comparative Features of Adrenaline and Noradrenaline

Adrenaline	Noradrenaline
Catecholamine	Catecholamine
Direct-acting sympathomimetic agent— α_1 -, α_2 -, β_1 -, β_2 -, β_3 -agonist	Direct-acting sympathomimetic agent— α_1 -, α_2 -, β_1 -agonist
Administered by s.c., i.m. and slow i.v. routes	Administered by i.v. infusion only
Powerful cardiac stimulant—increases heart rate and force of contraction	Cardiac stimulant, but heart rate decreases due to reflex bradycardia
On i.v. administration, in moderate doses, it produces typical biphasic response—initial rise in BP (α_1 -blood vessels and β_1 -heart action) followed by a fall in BP due to β_2 -mediated vasodilatation in skeletal muscle	No biphasic response seen because of its negligible β_2 action
Increase in blood glucose	Slight increase in blood glucose only in large doses
Powerful bronchodilator	No bronchodilating effect
Uses: Anaphylactic shock, Bronchial asthma (acute), Cardiac resuscitation to prolong the Duration of local anaesthetics, Control Epistaxis and bleeding following tooth extraction, etc.	Uses: To raise blood pressure in hypotensive states

is used to increase the heart rate in heart block. In bronchial asthma, isoprenaline has been replaced by selective β_2 -agonists. Side effects are tachycardia, palpitation, cardiac arrhythmias, etc. due to its powerful cardiac-stimulant effect.

▮ Dobutamine: Relatively Selective β_1 -Agonist

Dobutamine, a synthetic catecholamine, structurally resembles dopamine. It is a potent inotropic agent, but causes only slight increase in heart rate. Total peripheral resistance is not significantly affected. It is administered by i.v. infusion in patients with acute heart failure. The side effects are tachycardia, rise in BP, etc.

▮ Salbutamol, Terbutaline, Salmeterol, Formoterol: Selective β_2 -Adrenergic Agonists

The main adverse effects of nonselective β -agonists, e.g. adrenaline, isoprenaline, etc. are on the heart. They can cause tachycardia, palpitation, cardiac arrhythmias and may even precipitate angina or myocardial infarction. Use of isoprenaline is almost obsolete for the treatment of asthma. Selective β_2 -agonists are the main drugs used in bronchial asthma, e.g. salbutamol, terbutaline, salmeterol, formoterol, etc.

Pharmacological actions

Pharmacological actions of selective β_2 -agonists are depicted in Figure 3.22. They cause bronchodilatation, relaxation of pregnant uterus, dilatation of blood vessels supplying the skeletal muscles, promote hepatic glycogenolysis and uptake of K^+ into the cells.

Therapeutic uses

1. **Bronchial asthma:** Selective β_2 -agonists are usually administered by aerosol. They produce prompt bronchodilatation (salbutamol and formoterol) with minimal systemic side effects (see p. 216).
2. **Premature labour:** On oral or parenteral administration, salbutamol and terbutaline relax pregnant uterus by interacting with β_2 -receptors; hence they are used to delay premature labour.
3. **Hyperkalaemia:** Selective β_2 -agonists are useful in hyperkalaemia as they promote the uptake of K^+ into cells, especially into skeletal muscles.

Adverse effects of selective β -agonists

1. **Tremor** is due to the stimulation of β_2 -receptors of skeletal muscle. Tolerance develops to this effect on continued administration.

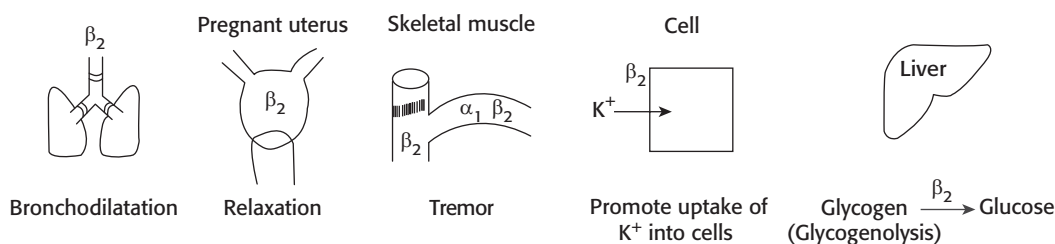
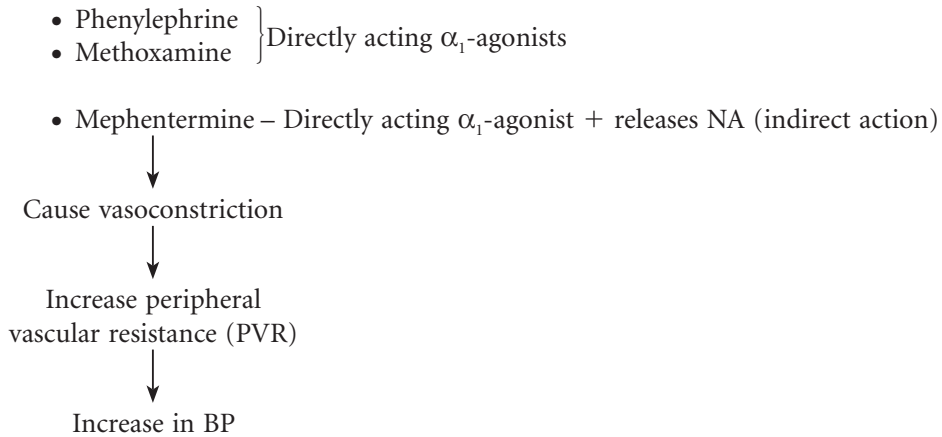

Fig. 3.22 Pharmacological actions of selective β_2 -agonists.

2. **Tachycardia** and palpitation are due to stimulation of β_1 -receptors of heart (β_2 -selectivity is not absolute—may cause cardiac side effects).
3. **Hyperglycaemia** may occur in diabetics following parenteral administration of β_2 -agonists.
4. **Hypokalaemia** is due to shift of K^+ into cells.

Phenylephrine, Methoxamine, Mephentermine: Selective α_1 -Adrenergic Agonists



Like ephedrine, mephentermine also has cardiac-stimulant effect. They are used parenterally to raise the BP in hypotensive states. Phenylephrine is also used topically as a mydriatic and a nasal decongestant.

Nasal Decongestants

The commonly used α -agonists as nasal decongestants are naphazoline, oxymetazoline, xylometazoline (topical); pseudoephedrine (oral) and phenylephrine (oral, topical). They are used in allergic rhinitis, common cold, sinusitis, etc. These drugs stimulate α -receptors and cause vasoconstriction in the nasal mucous membrane, thus relieve nasal congestion. On prolonged use, they cause rebound congestion (after congestion). Atrophic rhinitis, anosmia and local irritation are the other adverse effects seen with topical decongestants. If systemically absorbed, these drugs may aggravate hypertension.

Pseudoephedrine and phenylephrine are the commonly used oral preparations. They are usually combined with antihistaminics in anticold preparations. These drugs cause less rebound phenomenon, but systemic side effects like hypertension and CNS stimulation are common. They should not be combined with MAO inhibitors because of risk of hypertensive crisis, which could be fatal. Phenylpropanolamine was used as a nasal decongestant. It has been banned because of increased incidence of stroke.

Selective α_2 -Adrenergic Agonists

They include clonidine (see p. 104), α -methyldopa (see p. 105) and tizanidine (see p. 71). Apraclonidine, selective α_2 -agonist, is topically used in glaucoma (see p. 60).

■ Indirect-acting Sympathomimetics

▶ Amphetamine

Amphetamine is an indirect-acting sympathomimetic agent and has a potent CNS-stimulant effect. It occurs in two isomers. The *d*-isomer has more potent CNS effects and the *l*-isomer on CVS. The side effects are restlessness, insomnia, confusion, fatigue, tremor, hallucinations and suicidal tendencies. The cardiac side effects are tachycardia, palpitation, hypertension, angina and cardiac arrhythmias.

Treatment of acute intoxication

1. Acidification of urine with ascorbic acid (vitamin C) promotes the excretion of amphetamine, which is a basic drug.
2. Sedatives are effective to control CNS symptoms and sodium nitroprusside for severe hypertension.

Uses

1. **Narcolepsy:** It is a sleep disorder characterized by recurrent episodes of uncontrollable desire for sleep. Amphetamine improves narcolepsy by its CNS-stimulant effect.
2. **As an anorexiant:** Amphetamine-like drugs reduce body weight by suppressing hypothalamic feeding centre. Tolerance to this effect develops rapidly.
3. **Attention-deficit hyperkinetic disorder:** Amphetamine acts paradoxically and controls the activity in children with hyperkinetic disorder. The main adverse effects are loss of appetite and insomnia. *Methylphenidate* and *dextroamphetamine* are also useful in this disorder.

■ Mixed-acting Sympathomimetics

▶ Ephedrine: α - and β -Agonist with NA Release

Ephedrine is a mixed-acting adrenergic agonist. It is an alkaloid, acts on α_1 -, α_2 -, β_1 -, β_2 -receptors and releases NA from sympathetic nerve endings.

Pharmacological actions

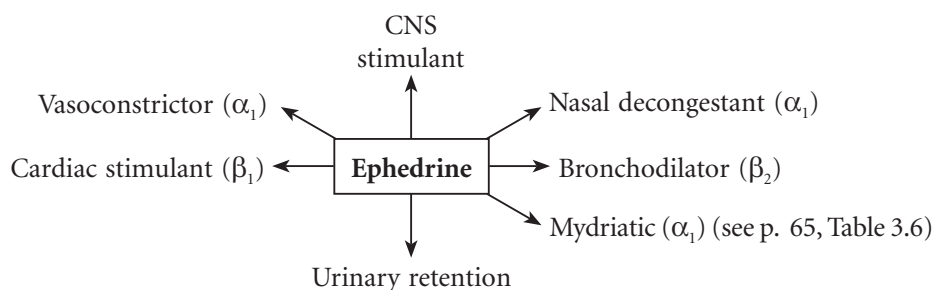

Uses

Intravenous ephedrine is the drug of choice to treat hypotension due to spinal anaesthesia as it increases peripheral vascular resistance, heart rate, cardiac output and thus BP. It was used in heart block, narcolepsy and more frequently in bronchial asthma. Now, it has been replaced by more selective drugs. The side effects are due to the extension of its pharmacological actions. They are insomnia, hypertension, tachycardia, palpitation, difficulty in urination; tachyphylaxis occurs on repeated administration.

► Dopamine: α_1 -, α_2 -, β_1 - and Dopamine-receptor Agonist with NA Release

Dopamine (DA) is a catecholamine and the immediate metabolic precursor of noradrenaline (NA). It acts on dopaminergic D_1 receptors as well as β_1 - and α_1 -adrenergic receptors. DA, like adrenaline and noradrenaline, is not effective orally. Dopamine is rapidly inactivated by COMT and MAO, and is administered by i.v. infusion.

Pharmacological actions

- **At low doses (<2 mcg/kg/min)**, it selectively dilates renal, mesenteric and coronary blood vessels by acting on D_1 receptors resulting in an increase in glomerular filtration rate (GFR) and urine output.
- **At moderate doses (2–5 mcg/kg/min)**, dopamine stimulates β_1 -receptors of heart, increases myocardial contractility and cardiac output, but tachycardia is less prominent. It also stimulates dopaminergic receptors resulting in increase in GFR.
- **At high doses (>10 mcg/kg/min)**, it stimulates vascular α_1 -adrenergic receptors and causes generalized vasoconstriction. This increases afterload and reduces blood flow to renal, mesenteric and other vital organs. So, the beneficial effect seen with low-to-moderate dose of DA is lost at higher doses.

Precautions and adverse effects

During dopamine infusion, the dose, BP, heart rate, ECG and urine output should be carefully monitored. The adverse effects seen are mainly due to sympathetic stimulation. They are nausea, vomiting, headache, hypertension, tachycardia, cardiac arrhythmias and angina.

Therapeutic uses

1. **Cardiogenic and septic shock:** Dopamine can be used because it increases BP as well as selectively dilates renal, mesenteric, coronary blood vessels and improves blood flow to vital organs.
2. **Severe heart failure with renal impairment:** Dopamine improves both cardiac and renal function.

► Anorectics (Anorexiant)

Amphetamine-like drugs promote weight loss by acting on hypothalamic feeding centre.

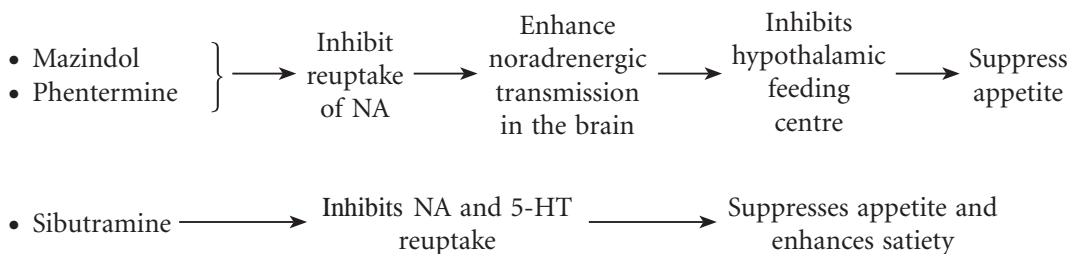

The main adverse effects of these agents are addiction liability, rise in BP, palpitation, sleep disturbances, depression and dry mouth.

Key Points for Dentists

- Check the strength and expiry date of adrenaline before administration.
- Adrenaline should be avoided in patients with hypertension, angina, cardiac arrhythmias, CCF, etc.; also in patients on β -blockers.
- Care should be taken to avoid extravasation of noradrenaline during infusion, as it will lead to necrosis of surrounding tissues.
- Monitor pulse, BP and urine output in patients receiving dopamine infusion.

ADRENERGIC RECEPTOR BLOCKERS

Adrenergic-receptor antagonists block the effects of sympathetic stimulation and adrenergic agonists mediated through α - and β -receptors.

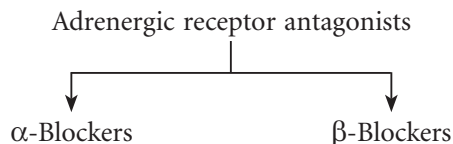

ALPHA-ADRENERGIC BLOCKERS

Pharmacological effects of α -blockers (Fig. 3.23)

They block the α -receptors, thus inhibiting the α -receptor-mediated responses of sympathetic stimulation and adrenergic drugs.

Classification

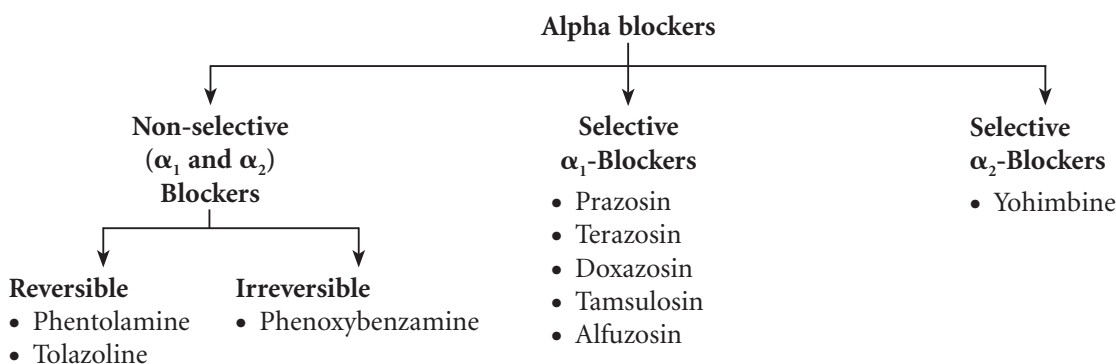

■ Irreversible Nonselective α -Blocker

● Phenoxybenzamine

Phenoxybenzamine is a nonselective α -adrenergic blocker that blocks both α_1 - and α_2 -receptors. It binds covalently to α -receptors and causes irreversible blockade. It also inhibits the reuptake of NA into the adrenergic nerve endings.

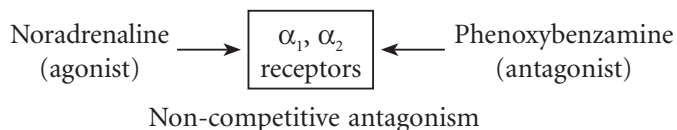

Pharmacological effects

1. Peripheral vascular resistance is reduced due to the blockade of vascular α_1 -receptors.
2. Increased release of NA from the adrenergic nerve endings due to the blockade of presynaptic α_2 -receptors. This may cause cardiac stimulation and produce tachycardia, palpitation, cardiac arrhythmias, etc.

Phenoxybenzamine is given orally or through slow i.v. infusion. It has a slow onset but long duration of action because of irreversible blockade of α -receptors. Its main use is in the treatment of pheochromocytoma. The side effects are postural hypotension, tachycardia, palpitation, diarrhoea, nasal stuffiness, giddiness and impotence.

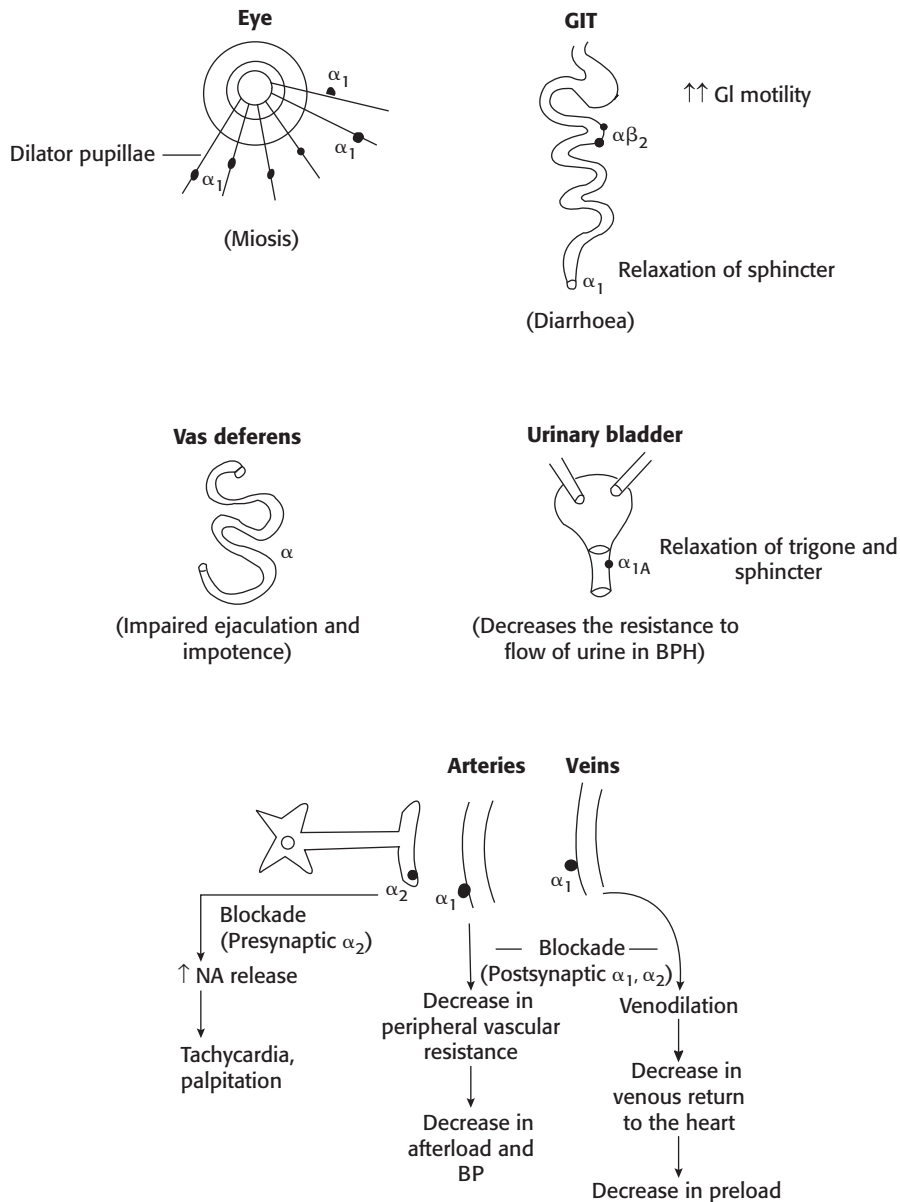
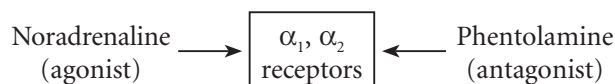

Fig. 3.23 Effect of α -blockade at various sites. GIT, gastrointestinal tract; BPH, benign prostatic hyperplasia; NA, noradrenaline. **Other effects: Blockade of alpha-receptors in nasal blood vessels results in nasal stuffiness.**

■ Reversible Nonselective α -Blocker

▶ Phentolamine

Phentolamine is an imidazoline derivative. It competitively blocks the effects of NA at both α_1 - and α_2 -adrenergic receptors. It can also block 5-HT receptors, K^+ channels and cause histamine release from mast cells.



Competitive antagonism

Phentolamine is given intravenously and has rapid onset but short duration of action. It is used intraoperatively during surgery of phaeochromocytoma, in hypertensive emergencies (for details, see uses of α -blockers) and to prevent tissue necrosis due to extravasation of α_1 -agonists.

Adverse effects

They include tachycardia, palpitation, arrhythmias; angina and MI may be precipitated.

▶ Tolazoline

Tolazoline is similar to phentolamine and is rarely used.

■ Selective α_1 -Blockers

Prazosin is a potent and selective α_1 -adrenergic receptor blocker. It is given orally. It is well absorbed from GI tract, but undergoes extensive first-pass metabolism. The effects of α -blockade are depicted in the Fig. 3.23. Unlike nonselective α -blockers, selective α_1 -blockers produce minimal or no tachycardia.

Adverse effects

First-dose phenomenon: Within 30–90 min of oral administration of prazosin, severe postural hypotension and syncopal attacks may be seen with first dose. Therefore, the initial dose should be small (1 mg). It is usually given at bed time so that the patient remains in bed for several hours and the risk of syncopal attack is reduced.

Other selective α_1 -blockers

- **Terazosin** is similar to prazosin, but less potent than prazosin. It is almost completely absorbed after oral administration and has a longer duration of action.
- **Doxazosin** is the longest-acting, selective α_1 -blocker. The haemodynamic effects, bioavailability and extent of metabolism are similar to prazosin.
- **Alfuzosin** blocks all subtypes of α_1 -receptors (α_{1A} , α_{1B} and α_{1D}). It is orally effective and used in benign prostatic hyperplasia (BPH).
- **Tamsulosin** is an uroselective α_1 -blocker (α_{1A}). At low doses, it reduces the resistance to flow of urine with little effect on BP. It is administered orally and is the preferred α_1 -blocker for the treatment of benign prostatic hyperplasia (BPH) in normotensive patients. It may cause retrograde ejaculation.

Therapeutic Uses of α -Blockers

1. **Pheochromocytoma:** It is a tumour of adrenal medulla that releases large amounts of adrenaline and NA. The signs and symptoms include a sudden and paroxysmal rise in BP with headache, palpitation and excessive sweating. The diagnosis of pheochromocytoma is usually made by estimating vanillylmandelic acid (VMA) levels in urine (normal VMA: 4–8 mg/24 h urine sample), computed tomography (CT) and magnetic resonance imaging (MRI) scans.

The definitive treatment for pheochromocytoma is surgery. In the preoperative period, phenoxybenzamine is used to control hypertension and restore blood volume. It is a nonselective and irreversible α -blocker. Blockade of vascular α_1 -receptors causes vasodilatation and fall in BP.

Beta-blockers (propranolol) are used to control the cardiac manifestations—tachycardia and arrhythmias due to excess catecholamines. Beta-blockers should not be given alone in pheochromocytoma because the blockade of vascular β_2 -receptors causes unopposed α_1 action, which leads to severe rise in BP due to vasoconstriction. This may be fatal. Therefore, prior administration of α -receptor blocker is a must before giving β -blockers.

Metyrosine is used as an adjuvant in pheochromocytoma. It inhibits tyrosine hydroxylase enzyme and reduces the synthesis of catecholamines.

During surgery, handling of the tumour results in sudden release of large quantity of catecholamines, which may cause marked rise in BP that can be controlled by i.v. phentolamine. It is a nonselective α -blocker with rapid onset of action.

2. **Hypertensive emergencies:** Intravenous phentolamine can be used in the following conditions because of its rapid onset of action:
 - To control hypertensive episodes intraoperatively during surgery of pheochromocytoma.
 - To control hypertensive crisis due to clonidine withdrawal.
 - To control hypertensive crisis due to ‘cheese reaction’.
3. **Essential hypertension:** Among α -blockers, selective α_1 -antagonists are preferred in the treatment of mild-to-moderate hypertension. They cause less tachycardia and have favourable effects on lipid profile.
4. **Benign prostatic hyperplasia:** Medical therapy is helpful in many patients. Selective α_1 -blockers are used in BPH; they reduce the resistance to urinary flow. Prazosin, doxazosin, terazosin and alfuzosin are particularly useful in patients who also have hypertension. Tamsulosin is preferred for BPH in normotensive patients.
5. **Tissue necrosis:** Phentolamine is infiltrated locally to prevent tissue necrosis due to extravasation of α -agonists.

Key Points for Dentists

- When patients on α -blocker stand up suddenly from dental chair after the procedure, they may develop severe hypotension and syncope. Hence, monitoring of blood pressure is required in these patients.

BETA-ADRENERGIC BLOCKERS

Beta-adrenergic antagonists block the β -receptor-mediated effects of sympathetic stimulation and adrenergic drugs.

Classification

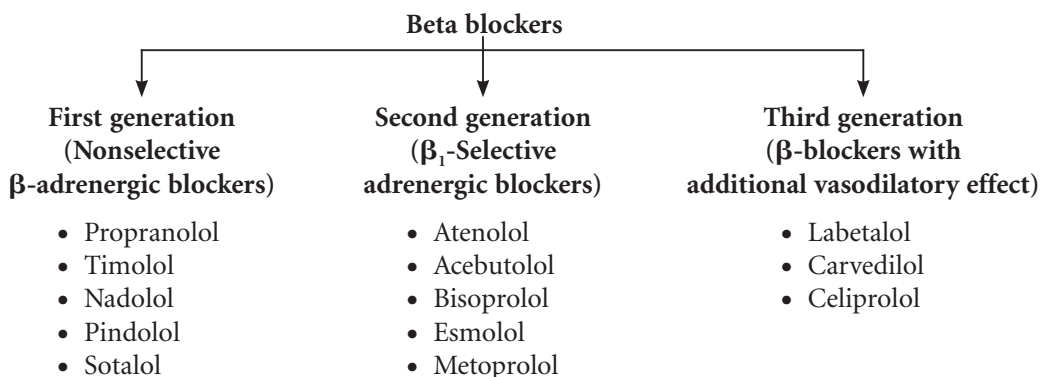

Pindolol, acebutolol, labetalol and celiprolol have partial agonistic activity (intrinsic sympathomimetic activity). They stimulate β -receptors partially in the absence of catecholamines.

Propranolol, acebutolol, carvedilol, labetalol, metoprolol, pindolol have membrane-stabilizing activity (local anaesthetic activity).

Mechanism of action

Propranolol is the prototype drug. β -Blockers competitively block the β -mediated actions of catecholamines and other adrenergic agonists.



Pharmacological actions

1. Cardiovascular system:

- a. *Heart*: β -Blockers depress all the cardiac properties.
 - i. Decrease heart rate (negative chronotropic effect).
 - ii. Decrease the force of myocardial contractility (negative inotropic effect).
 - iii. Decrease cardiac output.
 - iv. Depress S–A node and A–V nodal activity.
 - v. Increase refractory period of A–V node.
 - vi. Decrease conduction in atria and A–V node (negative dromotropic effect).
 - vii. Decrease automaticity of ectopic foci.
 - viii. Decrease cardiac work, thus reduce O_2 requirement of the myocardium.

Only in high doses, some of them have membrane-stabilizing effect.

- b. *Blood vessels*: Blockade of β_2 -receptors of the blood vessels initially may cause rise in peripheral vascular resistance due to the unopposed α_1 -action. **However, continued administration of these drugs leads to a fall in peripheral vascular resistance (PVR) in patients with hypertension (reduce both systolic and diastolic BP).**
- c. They also reduce release of renin from juxtaglomerular apparatus due to blockade of β_1 -receptors.

2. *Respiratory system*: Blockade of β_2 -receptors in bronchial smooth muscle can produce severe bronchospasm in patients with COPD and asthma. Therefore, β -blockers should be avoided in patients with asthma and COPD. Selective β_1 -blockers such as atenolol, metoprolol, etc. are less likely to cause bronchospasm.

3. **Skeletal muscle:** On chronic use, β -blockers may cause skeletal muscle weakness and tiredness due to blockade of β_2 -receptors of the skeletal muscle and blood vessels supplying it. They also reduce stress-induced tremors.
4. **Metabolic effects:** β -Blockers inhibit glycogenolysis and delay recovery from hypoglycaemia. They also mask the warning signs and symptoms of hypoglycaemia (see p. 94). Therefore, β -blockers should be used cautiously in diabetics on hypoglycaemic agents. Chronic use of nonselective β -blockers decreases high-density lipoprotein (HDL) cholesterol and low-density lipoprotein (LDL) cholesterol ratio, which may increase the risk of coronary artery disease.
5. **Eye:** β -Blockers on topical administration decrease IOP by reducing the secretion of aqueous humour (see p. 59).

Pharmacokinetics

Propranolol is highly lipid soluble and is well absorbed from GI tract. However, the bioavailability of propranolol is low because of its extensive first-pass metabolism. It is highly bound to plasma proteins; has large volume of distribution; freely crosses BBB, and metabolites are excreted in urine.

Adverse effects of β -blockers

They are mainly an extension of pharmacological actions.

1. **CVS:**
 - Bradycardia, heart block and may precipitate congestive heart failure in patients with low cardiac reserve.
 - Blockade of vascular β_2 -receptors causes unopposed α_1 action, further reduces blood supply and may worsen peripheral vascular diseases.
 - β -Blockers can exacerbate Prinzmetal's angina (variant angina) due to unopposed α_1 action, hence are contraindicated.
2. **Respiratory system:** Blockade of β_2 -receptors in the bronchial smooth muscle can cause severe bronchospasm in patients with asthma and COPD. Hence, β -blockers are contraindicated in the above conditions.
3. **CNS:** Sleep disturbances, hallucinations, fatigue and mental depression.
4. **Metabolic:** Hypoglycaemia is common with nonselective (β -blockers especially in diabetics on hypoglycaemic agents. β -Blockers may also mask the warning signs and symptoms of hypoglycaemia.
5. **Muscular weakness and tiredness:** These are due to reduced blood flow to skeletal muscle.
6. **Withdrawal symptoms:** Abrupt withdrawal of β -blockers after chronic use is dangerous because they can precipitate angina or frank myocardial infarction and even sudden death. This is due to the upregulation (supersensitivity) of β -receptors in response to prolonged blockade (see p. 27, Table 1.5).

Drug interactions

1. **Propranolol \times verapamil:** They produce additive cardiac depressant effects and may cause CCF, bradyarrhythmias, heart block or even cardiac arrest.
2. **Propranolol \times lignocaine:** Propranolol reduces the clearance of lignocaine by decreasing hepatic blood flow.
3. **Insulin/sulfonylureas \times β -blockers:** Nonselective β -blockers inhibit glycogenolysis and delay recovery from hypoglycaemia (Fig. 3.24).
4. **Propranolol \times nonsteroidal antiinflammatory drugs (NSAIDs):** NSAIDs by inhibiting prostaglandin synthesis, promote Na^+ and water retention on chronic use. Thus, they decrease antihypertensive effect of β -blockers.

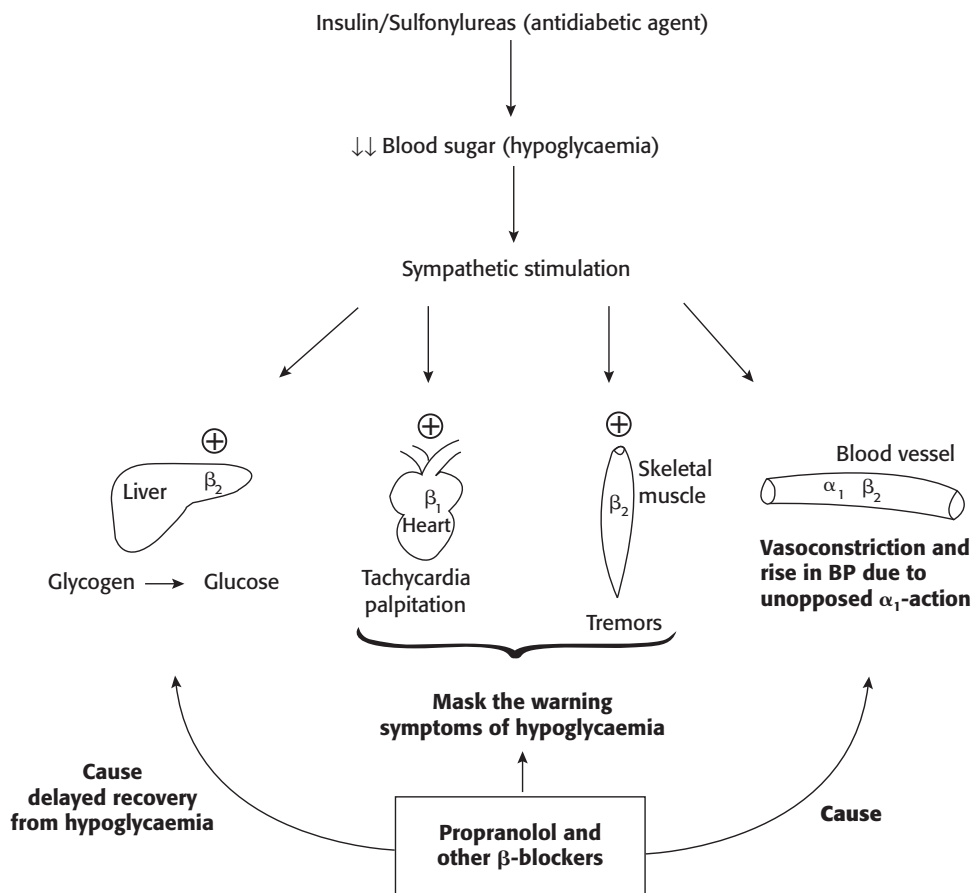

Fig. 3.24 Interaction between insulin/sulfonylureas and β -blockers.

Therapeutic uses of β -blockers

1. **Hypertension:** β -Blockers are useful for all grades of hypertension (see page 103). These drugs are preferred especially in patients with coexisting angina, myocardial infarction or cardiac arrhythmias.

The advantages of β -blockers are:

- Sodium and water retention is rare.
- Cheaper.
- Have a long duration of action.
- Well tolerated.

2. **Angina pectoris and MI:** β -Blockers reduce myocardial O_2 demand by decreasing heart rate, myocardial contractility and blood pressure. They improve exercise tolerance and reduce frequency of anginal episodes. Use of β -blockers early in acute phase of MI may limit infarct size. Long-term use of β -blockers may reduce mortality and reinfarction.
3. **Cardiac arrhythmias:** β -Blockers are mainly used in atrial arrhythmias such as atrial fibrillation, atrial flutter, etc.; but rarely for ventricular arrhythmias.

4. **Congestive cardiac failure** (see p. 120-121): Chronic use of β -blockers such as carvedilol, metoprolol and bisoprolol has shown to reduce the mortality rate in chronic heart failure.
5. **Pheochromocytoma**: β -Blockers are used to control the cardiac manifestations of pheochromocytoma, but should not be given alone (see p. 91).
6. **Glaucoma** (see p. 59): β -Blockers decrease the IOP by reducing the production of aqueous humour. They are useful in the treatment of glaucoma. Timolol, carteolol, levobunolol, betaxolol, etc. are used topically in glaucoma. Timolol is the most frequently used β -blocker in glaucoma.
7. **Prophylaxis of migraine**: Propranolol, atenolol and metoprolol are effective in reducing the frequency of migraine headache. The mechanism is not known.
8. **Hyperthyroidism**: The signs and symptoms of hyperthyroidism such as tachycardia, palpitation, tremor, anxiety, etc. are reduced due to blockade of β -receptors. Propranolol inhibits the peripheral conversion of T_4 – T_3 (see p. 266). It is used in thyroid storm.
9. **Essential tremors**: Oral propranolol may give some benefit in patients with essential tremors.
10. **Acute anxiety states**: β -Blockers are useful in controlling the symptoms of acute anxiety such as palpitation, tachycardia, tremor, sweating, etc.

Important features of beta-blockers are given in Table 3.11.

Table 3.11 β -Blockers with Important Features

β -Blocker	ISA	MSA	Lipid Solubility	Route/s
Propranolol	–	++	High	Oral, i.v.
Timolol	–	–	Moderate	Oral, topical (eye drops)
Nadolol	–	–	Low	Oral
Pindolol	++	+	Low	Oral
Atenolol	–	–	Low	Oral
Acebutolol	+	+	Low	Oral, i.v.
Esmolol	–	–	Low	Intravenous
Metoprolol	–	+	Moderate	Oral, i.v.
Bisoprolol	–	–	Low	Oral
Labetalol	+	+	Low	Oral, i.v.
Carvedilol	–	++	Moderate	Oral
Celiprolol	+	–	Low	Oral

ISA, intrinsic sympathomimetic activity; MSA, membrane stabilizing activity; –, no activity; +, some activity; ++, moderate activity.

■ Selective β_1 -adrenergic Blockers

● Esmolol

- It is administered intravenously.
- Its $t_{1/2}$ is about 10 min.
- It has no membrane-stabilizing effect.

- It is a selective β_1 -blocker and has short duration of action.
- It is rapidly metabolized by esterases in RBCs.
Esmolol is used in hypertensive emergencies and for rapid control of ventricular rate in supraventricular arrhythmias.

Atenolol

See Table 3.12.

Table 3.12 Differences Between Propranolol and Atenolol

Propranolol	Atenolol
Nonselective β -blocker	Selective β_1 -blocker
In large doses, has membrane-stabilizing effect (local anaesthetic)	Has no membrane-stabilizing effect
Highly lipid soluble, freely crosses BBB and produces central side effects	Poorly lipid soluble, hence central side effects are rare
Has shorter duration of action, but propranolol SR formulation has a duration of 24 h	Has longer duration of action, given once daily
Less potent	More potent

β -Blockers with Additional Vasodilatory Action

Labetalol

It is a competitive blocker at β_1 -, β_2 - and α_1 -adrenergic receptors. It is administered orally or intravenously. It undergoes extensive first-pass metabolism after oral administration; hence its bioavailability is poor. Oral labetalol is useful in the treatment of essential hypertension and i.v. labetalol for hypertensive emergencies. The important side effects are postural hypotension and hepatotoxicity.

Carvedilol

Like labetalol, it also blocks β_1 -, β_2 - and α_1 -adrenergic receptors. In addition, carvedilol has antioxidant, antiproliferative, membrane-stabilizing and vasodilatory properties. It has cardioprotective effect; hence the long-term use reduces the mortality in patients with congestive heart failure (CHF).

Celiprolol

It is a third-generation selective β_1 -blocker; has weak vasodilating and bronchodilating effects. It is effective in the treatment of hypertension and angina.

Key Points for Dentists

- Beta-blockers should be cautiously used in patients on antidiabetic agents.
- Beta-blockers should be avoided in asthmatics.
- Simultaneous administration of β -blockers and verapamil should be avoided.

Drugs Affecting Cardiovascular Function

4

HYPERTENSION

Hypertension is a common cardiovascular disease affecting worldwide population. A persistent and sustained high blood pressure has damaging effects on the heart, brain, kidneys and eyes. Hypertension could be:

1. **Primary or essential hypertension:** It is the most common type. There is no specific underlying cause.
2. **Secondary hypertension:** It can be due to renal, vascular, endocrine disorders, etc.

■ Blood Pressure (Table 4.1)

- **Systolic blood pressure (SBP):** It is the maximum pressure recorded during ventricular systole.
- **Diastolic blood pressure (DBP):** It is the minimum pressure recorded during ventricular diastole.
- **Pulse pressure (PP):** It is the difference between systolic and diastolic blood pressure ($PP = SBP - DBP$).
- **Mean arterial pressure:** $DBP + 1/3PP$.

Table 4.1 Classification of Blood Pressure for Adults

Category	Blood Pressure (mmHg)	
	Systolic	Diastolic
Normal	<120	<80
Prehypertension	120–139	80–89
Hypertension		
Stage 1	140–159	90–99
Stage 2	≥160	≥100

■ Classification of Antihypertensive Drugs (Fig. 4.1)

1. **ACE inhibitors:** Captopril, enalapril, lisinopril, perindopril, ramipril.
2. **Angiotensin II receptor antagonists:** Losartan, candesartan, irbesartan, valsartan.
3. **Calcium channel blockers:** Diltiazem, verapamil, nifedipine SR, amlodipine, nicardipine, isradipine, felodipine.

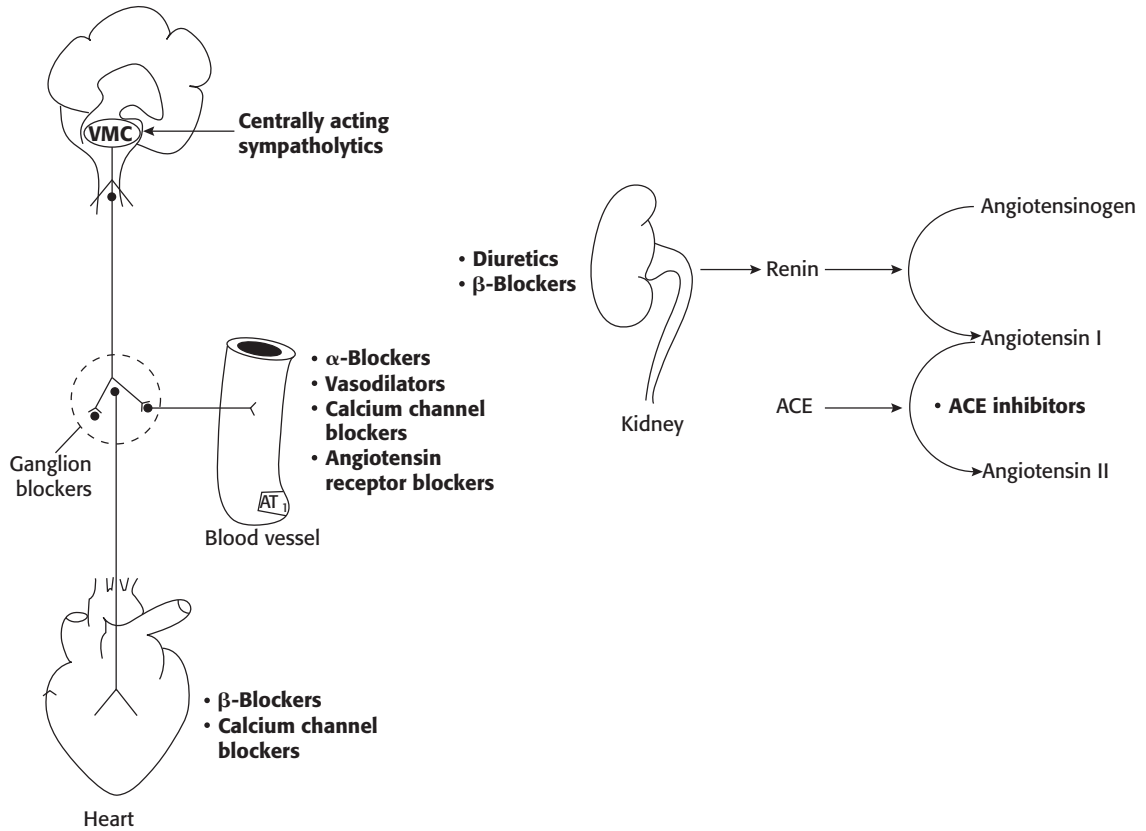

Fig. 4.1 Sites of action of major groups of antihypertensive drugs. VMC, vasomotor centre (medulla); ACE, angiotensin converting enzyme; and AT_1 , angiotensin receptor.

4. Diuretics

- Thiazides and related agents:** Chlorothiazide, hydrochlorothiazide, chlorthalidone, indapamide.
- Loop diuretics:** Furosemide, bumetanide, torsemide.
- Potassium-sparing diuretics:** Amiloride, triamterene, spironolactone.

5. Sympatholytic agents

- Centrally acting adrenergic drugs:** Clonidine, methyldopa.
- β -Adrenergic blockers:** Atenolol, metoprolol, esmolol, propranolol, timolol.
- β -Adrenergic blockers with additional α -blocking activity:** Labetalol, carvedilol.
- α -Adrenergic blockers:**
 - Selective:** Prazosin, terazosin, doxazosin.
 - Nonselective:** Phenoxybenzamine, phentolamine.

6. Vasodilators

- Arteriolar:** Hydralazine, minoxidil, diazoxide.
- Arteriolar and venodilator:** Sodium nitroprusside.

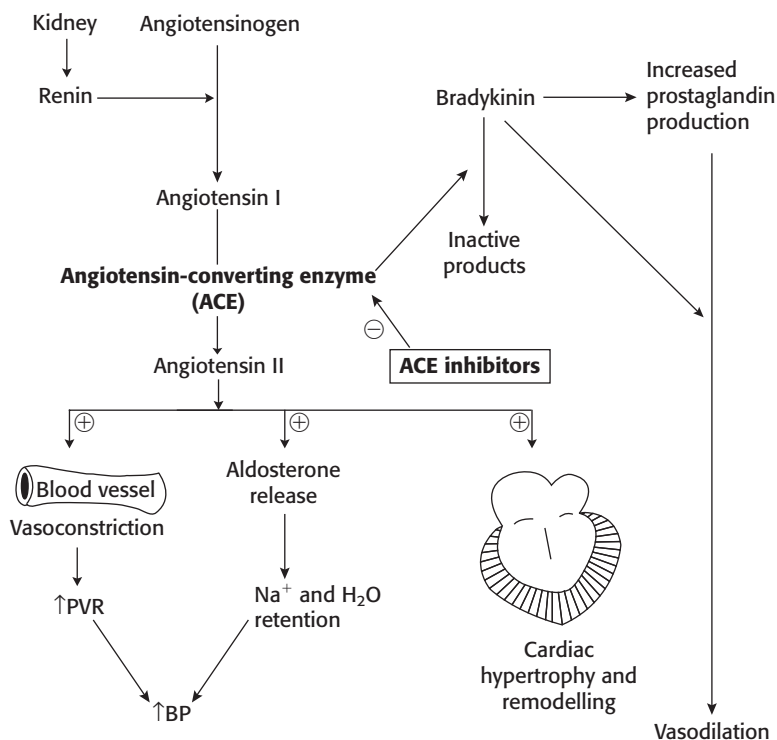

Fig. 4.2 Site of action of ACE inhibitors. Effects of angiotensin II are prevented by ACE inhibitors.

■ Angiotensin Converting Enzyme Inhibitors (Fig. 4.2)

Angiotensin converting enzyme inhibitors (ACE inhibitors) are frequently used as the first-line antihypertensive drugs.

Mechanism of action

Angiotensin converting enzyme inhibitors:

- a. Inhibit the generation of angiotensin II resulting in:
 - Dilatation of arterioles \rightarrow \downarrow peripheral vascular resistance (PVR) \rightarrow \downarrow BP.
 - Decrease in aldosterone production \rightarrow decrease in Na^+ and H_2O retention \rightarrow \downarrow BP.
 - Decrease in sympathetic nervous system activity.
- b. Inhibit the degradation of bradykinin, which is a potent vasodilator.
- c. Stimulate synthesis of vasodilating prostaglandins through bradykinin.

All these actions contribute to their antihypertensive effect.

Pharmacokinetics

ACE inhibitors are usually given orally. In hypertensive emergency, enalaprilat can be given intravenously. Food reduces the absorption of captopril; hence, it should be given 1 h before meals. They poorly cross the blood–brain barrier (BBB), are metabolized in liver and excreted in urine (Table 4.2).

Table 4.2 Pharmacokinetic Features of ACE Inhibitors

Drug	Captopril	Enalapril	Lisinopril	Perindopril	Ramipril
Active/Prodrug	Active	Prodrug	Active	Prodrug	Prodrug
Absorption	Well absorbed; food reduces the absorption, hence given 1 hour before food	Rapidly absorbed but undergoes extensive first-pass effect. Food does not reduce its absorption	Slowly and incompletely absorbed; food does not affect its absorption	Poorly absorbed; food does not affect its absorption	Rapidly absorbed
Duration of action	8–12 h	24 h	>24 h	>24 h	>24 h
Route of excretion	Kidney	Kidney	Kidney	Kidney	Kidney

Adverse effects* and contraindications

1. Cough (dry cough) is due to increased bradykinin levels in the lungs. Appearance of intractable cough is an indication to stop the drug.
2. Angioedema: Swelling in the nose, lips, mouth, throat, larynx, glottis. There can be airway obstruction—patient's airway should be protected. If required, adrenaline, glucocorticoids and antihistaminics should be administered.
3. Proteinuria.
4. Teratogenic effect (growth retardation, fetal hypotension, renal failure and neonatal death)—hence contraindicated in pregnancy.
5. Severe hypotension may occur 1–2 hour after taking the first dose. Hence, ACE inhibitors should be started with a small dose and then gradually increased.
6. Neutropenia.
7. Rashes.
8. Itching.
9. Loss of taste sensation (dysgeusia) and nausea.

In patients receiving ACE inhibitors, hyperkalaemia may occur in the presence of renal insufficiency or when they are combined with potassium-sparing diuretics.

ACE inhibitors are contraindicated in patients with bilateral renal artery stenosis. ACE inhibitors are also contraindicated in patients with single kidney with renal artery stenosis, as they can precipitate renal failure.

Drug interactions

1. **ACE inhibitors** × **potassium-sparing diuretics**: Simultaneous administration of these drugs can cause dangerous hyperkalaemia.
2. **ACE inhibitors** × **lithium**: ACE inhibitors retard the renal elimination of lithium and potentiate its toxicity.
3. **ACE inhibitors** × **NSAIDs**: NSAIDs by inhibiting prostaglandin (PG) synthesis, promote Na⁺ and water retention on chronic use. Thus, they decrease the antihypertensive effect of ACE inhibitors.

*Mnemonic for adverse effects of ACE inhibitors: 'CAPTOPRIL'.

Therapeutic uses of ACE inhibitors

1. **Hypertension:** (Mode of action: see above) ACE inhibitors are used in all grades of hypertension, especially in patients with diabetes and congestive heart failure (CHF). They are preferred in patients with diabetes because they delay or prevent the progression of renal complications.
2. **Congestive cardiac failure:** ACE inhibitors should be prescribed to all patients with impaired left ventricular function (for explanation see p. 120).
3. **Acute myocardial infarction:** ACE inhibitors should be started within 24 h in patients with myocardial infarction (MI). They have shown both short-term and long-term improvement in survival.
4. **Diabetic nephropathy:** ACE inhibitors and angiotensin II receptor blockers (ARBs) are the preferred drugs in diabetic nephropathy.

■ Angiotensin Receptor Blockers (ARBs) or Angiotensin Receptor Antagonists

The two types of angiotensin II-receptors are AT₁ and AT₂. Most of the effects of angiotensin II are mediated by AT₁ receptors. They are vasoconstriction, aldosterone secretion and the release of noradrenaline from sympathetic nerve endings. The role of AT₂ receptors is not known.

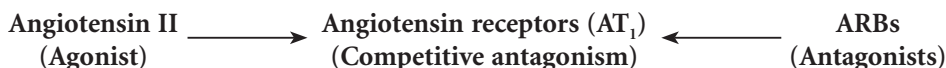

Angiotensin receptor blockers competitively inhibit the binding of angiotensin II to AT₁-receptor subtype and block its effects. ARBs produce effects similar to those of ACE inhibitors. ARBs do not affect bradykinin production.

Adverse effects

Angiotensin receptor blockers are better-tolerated as compared to ACE inhibitors. They cause headache, hypotension, weakness, rashes, nausea, vomiting and teratogenic effects. They may cause hyperkalaemia in patients with renal failure or in patients on K⁺-sparing diuretics. They are less likely to produce cough or angioedema than ACE inhibitors.

Uses

Angiotensin receptor blockers are used in hypertension, congestive cardiac failure (CCF), MI and diabetic nephropathy. The antihypertensive efficacy of ARBs is comparable with that of ACE inhibitors. Like ACE inhibitors, ARBs prevent/delay the development of renal complications in diabetics. ARBs are mainly indicated in patients who develop cough with ACE inhibitors. ARBs also reduce the progression of nephropathy in patients with diabetes.

In CCF and MI, ARBs are used in patients who are intolerant to ACE inhibitors (see p. 120).

■ Diuretics

Thiazides and related drugs are widely used drugs for uncomplicated hypertension. Hydrochlorothiazide, chlorthalidone and indapamide are the commonly used thiazides for hypertension.

Thiazide Diuretics

These are used in uncomplicated mild-to-moderate hypertension and have a long duration of action. They should be administered in a low dose, i.e. 12.5 mg of hydrochlorothiazide or chlorthalidone. If the antihypertensive response is not adequate, the dose can be increased up to 25 mg/day. Beyond this dose, thiazides are not safe. Potassium-sparing diuretics are usually given with thiazides to counteract K^+ loss and increase antihypertensive efficacy. Use of ACE inhibitors with thiazides decreases K^+ loss by thiazides and enhances antihypertensive effect.

Mechanism of action of thiazides

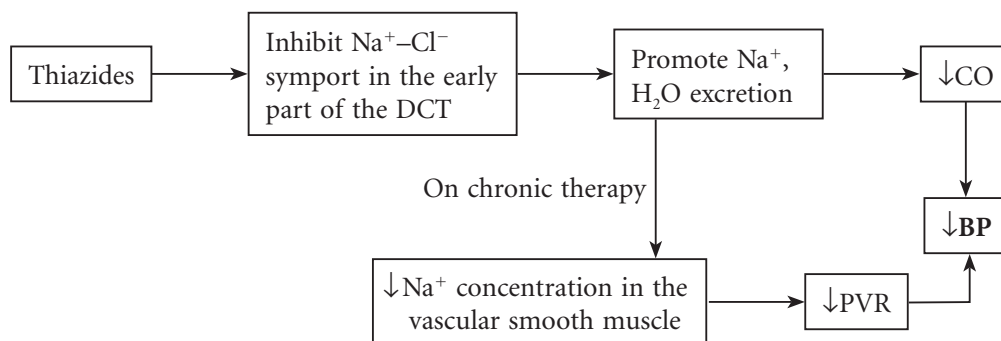

Adverse effects

They are hypokalaemia, hyperglycaemia, hyperuricaemia, hyperlipidaemia, hypercalcaemia, impotence and decreased libido.

Advantages of thiazides

- have long duration of action (administered once daily).
- are cheaper.
- are well tolerated even in elderly patients.
- decrease the incidence of fracture in elderly patients by reducing urinary Ca^{2+} excretion.
- have synergistic effect when used in combination with other antihypertensive drugs.

Loop Diuretics

These drugs have short duration of action; therefore, they are not used in hypertension except in the presence of renal or cardiac failure.

Calcium Channel Blockers (CCBs)

Verapamil, diltiazem and dihydropyridines (nifedipine, amlodipine, felodipine, nicardipine, isradipine, etc.) are useful in all grades of hypertension.

The antihypertensive effect is mainly due to peripheral vasodilatation. Dihydropyridines (DHPs) are more likely to cause headache, flushing, palpitation and reflex tachycardia. The use of sustained-release preparations reduces the incidence of side effects. β -Blockers can be used with nifedipine to counteract the reflex tachycardia. Reflex tachycardia is minimal or absent with verapamil and diltiazem because of their greater cardiac-depressant effect. Verapamil and diltiazem should be avoided in patients with cardiac dysfunction because of their cardiac depressant effect. CCBs are particularly useful in elderly

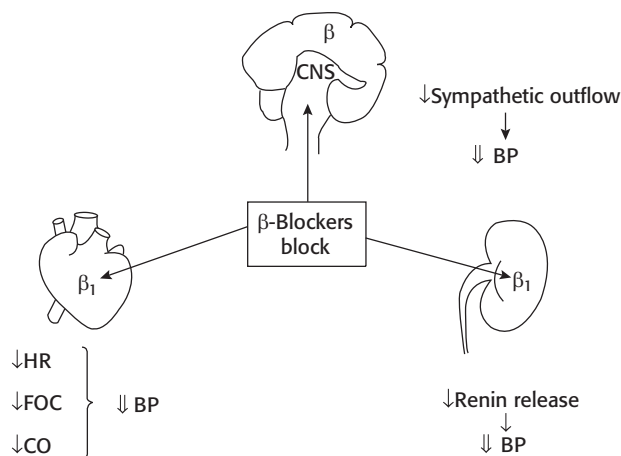

Fig. 4.3 Mechanism of antihypertensive effect of β -blockers.

patients and also in patients with angina, asthma, peripheral vascular diseases, migraine, hyperlipidaemia, diabetes and renal dysfunction.

■ Sympatholytics

▶ β -Adrenergic Blockers

β -Blockers are effective in all grades of hypertension.

- Selective β -blockers (block only β_1), e.g. atenolol, metoprolol, esmolol, etc.
- Nonselective β -blockers (block both β_1 and β_2), e.g. propranolol and timolol.

During initial therapy with β -blockers, the peripheral vascular resistance may increase initially. **On chronic therapy, peripheral vascular resistance gradually decreases because of the reduced cardiac output there is a fall in both systolic and diastolic BP.** Other mechanisms of antihypertensive effect are shown in Figure 4.3.

β -Blockers are mainly useful in:

- Young hypertensives with high renin levels.
- Patients with associated conditions, such as angina, post-MI, migraine and psychosomatic disorders.
- Patients receiving vasodilators to counteract reflex tachycardia.

β -Blockers may precipitate CCF and bronchospasm in susceptible individuals. They must be used with caution in diabetics receiving hypoglycaemic drugs. Sudden stoppage of β -blockers, after prolonged therapy, can produce withdrawal syndrome due to sympathetic overactivity (see p. 27, Table 1.5).

▶ Centrally Acting Sympatholytics

Clonidine

Clonidine is a centrally acting antihypertensive drug.

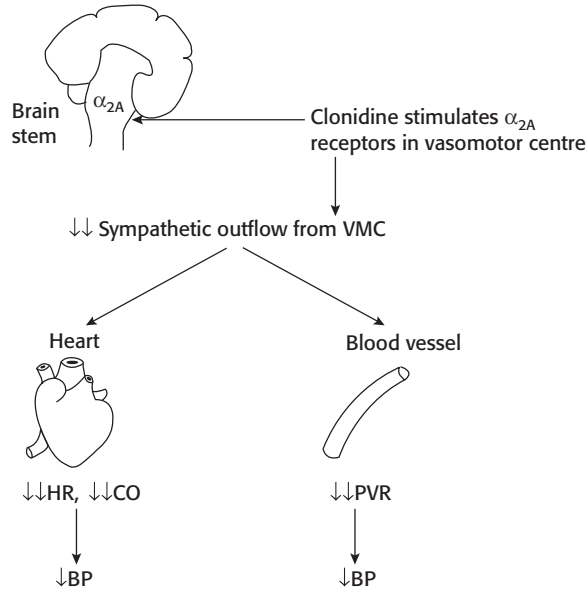

Fig. 4.4 Mechanism of action of clonidine.

Mechanism of action (Fig. 4.4)

Clonidine is effective orally; highly lipid soluble and rapidly crosses BBB. It has a short duration of action, requires twice a day administration. Transdermal patch of clonidine controls BP for a week.

Adverse effects

Dryness of mouth and eyes, sedation, depression, bradycardia, impotence, nausea, dizziness, parotid gland swelling and pain are the adverse effects of clonidine. Postural hypotension may occur.

Sudden stoppage of clonidine after prolonged use may cause withdrawal syndrome—headache, nervousness, tachycardia, sweating, tremors, palpitation and rebound hypertension. This is due to:

- Supersensitivity of α -receptors.
- Precipitous release of large amount of stored catecholamines.

This is treated with intravenous sodium nitroprusside or labetalol.

Uses

Clonidine is used:

1. In hypertension.
2. To treat withdrawal symptoms in opioid and alcohol addicts.
3. As preanaesthetic agent.
4. As antidiarrhoeal in diabetic neuropathy.

α -Methyldopa

It is a centrally acting sympatholytic agent.

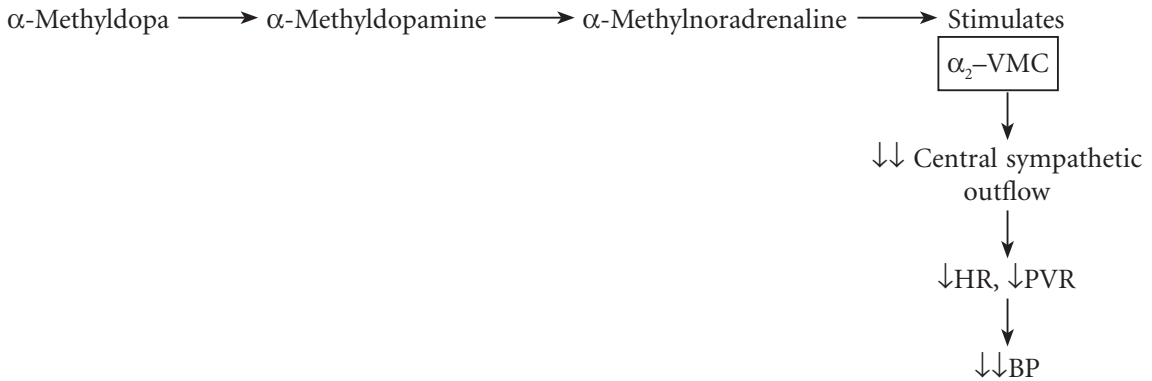
Mechanism of action

α -Methyldopa, a prodrug, which enters the adrenergic neuron, is converted into an active form and stored in the neurons. α -Methylnoradrenaline is a false transmitter that is released during nerve stimulation instead of noradrenaline. α -Methylnoradrenaline acts by stimulating α_2 -receptors in vasomotor centre (VMC).

Adverse effects

These include nasal stuffiness, headache, sedation, mental depression, dryness of mouth, bradycardia, impotence, gynaecomastia, hepatitis and rarely haemolytic anaemia.

Clonidine and α -methyldopa are usually employed as the second- or third-line agents in hypertension because of high incidence of side effects. α -Methyldopa is one of the preferred antihypertensive drugs during pregnancy.

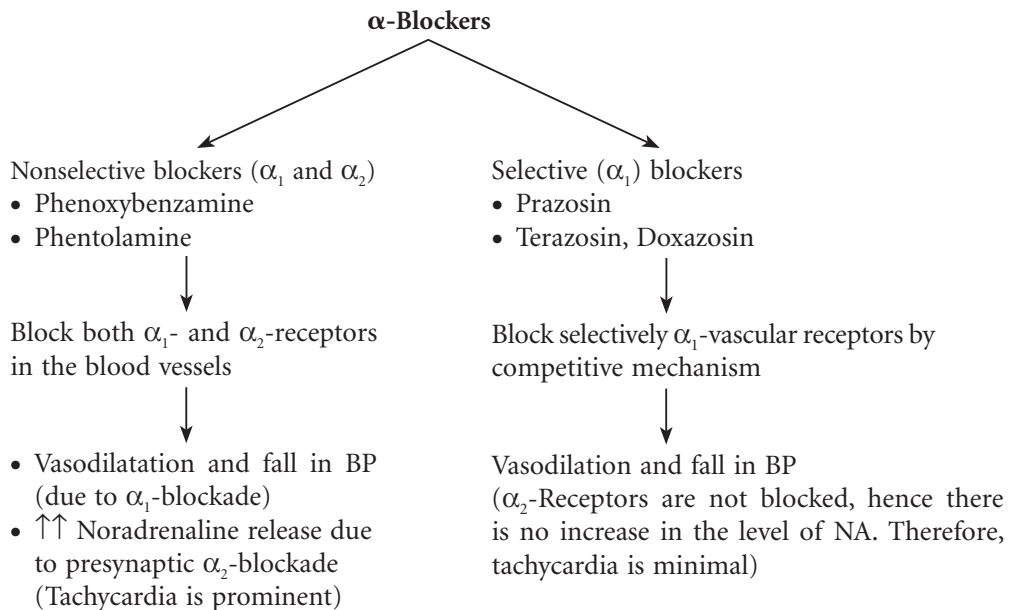
 α -Adrenergic Blockers

Nonselective α -blockers are not preferred for essential hypertension. They are used to treat hypertension in special conditions like pheochromocytoma, clonidine withdrawal and cheese reaction.

Pharmacokinetics, adverse effects and uses of α -blockers are discussed in pp. 88–91.

Selective α_1 -blockers: Prazosin causes first-dose phenomenon—postural hypotension that occurs after the first dose. Therefore, the initial dose should be small (1 mg) and usually given at bedtime so that the patient remains in bed for several hours, hence reduces the risk of fainting attacks.

Terazosin and doxazosin are longer acting than prazosin, given once daily in the treatment of hypertension.

Vasodilators

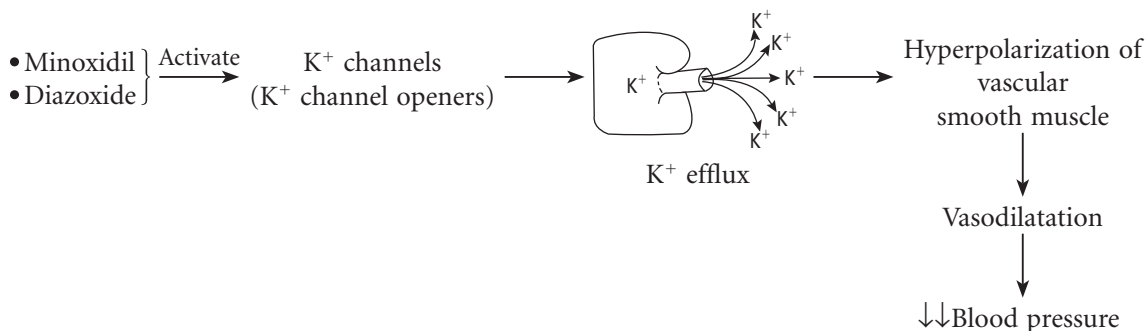

Minoxidil

It is a powerful arteriolar dilator. It is effective orally. It causes reflex tachycardia, Na⁺ and water retention. Hence, minoxidil is used with a β -blocker and a diuretic. Topical minoxidil is used to promote hair growth in male type of baldness. (Minoxidil topical solutions and sprays are available.)

Hydralazine

It is a directly acting arteriolar dilator. It is administered orally. The side effects are reflex tachycardia, palpitation, sodium and water retention, which can be countered by combining hydralazine with a diuretic and a β -blocker. Other side effects are headache, hypotension, flushing, angina, myocardial infarction, coronary steal phenomenon, etc. Immunological reactions such as lupus syndrome may occur.

Sodium Nitroprusside

It is a powerful arteriolar and venodilator (Fig. 4.5). It is unstable, rapidly decomposes on exposure to light. So the solution should be prepared fresh; the infusion bottle and the entire drip-set should be covered with black paper. It has a short duration of action, hence administered by i.v. infusion. It is rapid acting and dose is titrated according to response.

Sodium nitroprusside is the drug of choice for hypertensive crisis; can also be used to improve cardiac output in CCF. Nitroprusside can cause severe hypotension, hence close monitoring of BP is required.

Prolonged administration may cause anorexia, nausea, vomiting, fatigue, disorientation, toxic psychosis due to accumulation of cyanide, which in turn may lead to severe lactic acidosis.

Mechanism of action

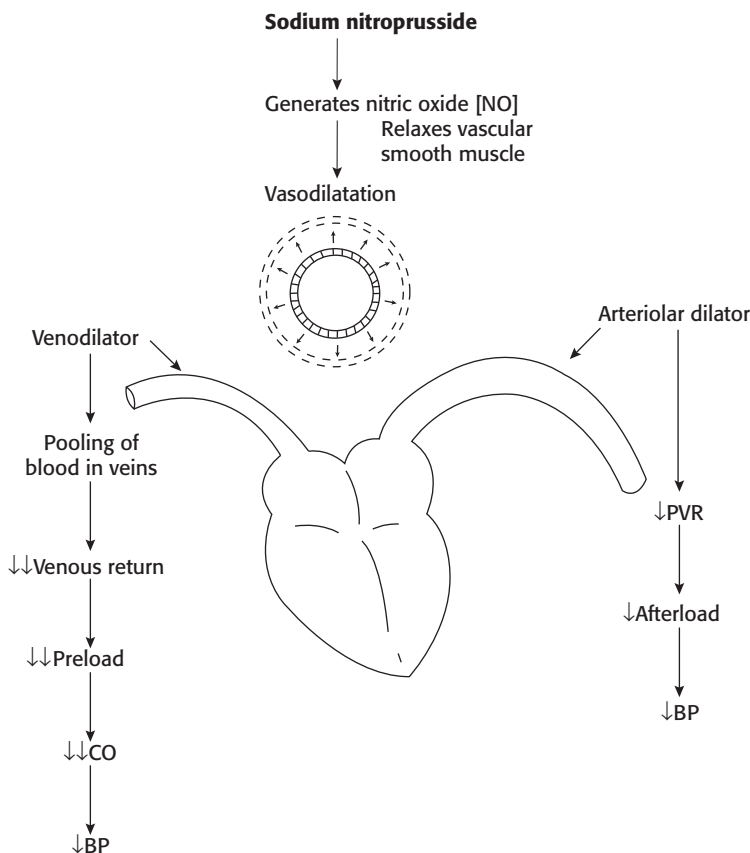

Fig. 4.5 Mechanism of action and effects of sodium nitroprusside.

■ Treatment of Hypertension

1. **Nonpharmacological** approaches helpful to control hypertension are weight reduction, sodium restriction, alcohol restriction, exercise, mental relaxation, cessation of smoking and consumption of potassium-rich diet.
2. **Drug treatment (see Table 4.3 and 4.4):** Selection of antihypertensive drugs in individual patients depends on: (i) co-existing disease, (ii) age, (iii) sex, (iv) cost of the drug and (v) concomitant drugs.

Drugs to be avoided in specific conditions

Bronchial asthma/COPD	Nonselective β -blockers
Peripheral vascular disease	Nonselective β -blockers
Diabetes mellitus	Nonselective β -blockers, thiazides and loop diuretics
Hyperlipidaemias	Thiazides and β -blockers
Gout	Thiazides
Sexually active males	α_1 -Blockers and diuretics

Table 4.3 Dosage and Indications of Antihypertensive Drugs

Drug	Dosage	Indications
Hydrochlorothiazide	12.5–25 mg, OD, oral	Mild hypertension
Chlorthalidone	12.5–25 mg, OD, oral	Mild hypertension
Enalapril	2.5–40 mg, OD, oral	Mild-to-severe hypertension, especially in diabetics
Lisinopril	5–40 mg, OD, oral	Mild-to-severe hypertension, especially in diabetics
Ramipril	1.25–20 mg, OD, oral	Mild-to-severe hypertension, especially in diabetics
Losartan	25–50 mg, OD or BD, oral	Mild-to-severe hypertension, especially in diabetics
Propranolol	10–120 mg, two–four times daily, oral	Mild-to-moderate hypertension
Atenolol	25–100 mg, OD, oral	Mild-to-moderate hypertension
Amlodipine	2.5–10 mg, OD, oral	Mild-to-moderate hypertension
α -Methyldopa	250 mg–2 g/day, oral	Hypertension during pregnancy

Table 4.4 Preferred Drugs for Hypertension Associated with the Following Conditions

Angina/Post-MI	β -Blockers
Congestive cardiac failure/Left ventricular failure	ACE inhibitors, loop diuretics and ARBs
Diabetes mellitus and diabetic nephropathy	ACE inhibitors and ARBs
Bronchial asthma/Chronic obstructive pulmonary disease	Calcium channel blockers
Hypertensive emergencies	Sodium nitroprusside
Benign prostatic hyperplasia (BPH)	Selective α_1 -blockers
Pregnancy	α -Methyldopa and hydralazine

Hypertensive Crisis (Hypertensive Emergencies)

It is characterized by a very high blood pressure (systolic >220 and/or diastolic >120 mm of Hg) with progressive end-organ damage such as retinopathy, renal dysfunction and/or hypertensive encephalopathy. It is a medical emergency. The BP should be reduced by not more than 25% within minutes to 2 h, and then to 160/100 mm of Hg within 2–6 h. The preferred drug to treat the condition is sodium nitroprusside (i.v. infusion). The other drugs that can be used in this condition are nitroglycerin (i.v. infusion), esmolol (slow i.v.), hydralazine (i.v.), enalaprilat (i.v.), labetalol (i.v.) and phentolamine (intravenously), etc.

Key Points for Dentists

- Recording of blood pressure is required for patients on antihypertensives before dental procedures.
- Alpha-blockers and vasodilators can cause giddiness (postural hypotension). Hence, patient should be advised to take care while getting up from dental chair.

ANTIANGINAL DRUGS

Angina and Myocardial Infarction

Angina pectoris is a symptom of ischaemic heart disease. It is due to an imbalance between oxygen supply and oxygen demand of the myocardium.

Types of angina pectoris

1. **Stable angina (classical angina):** It is characterized by episodes of chest pain commonly associated with exertion.
2. **Unstable angina:** It is characterized by angina at rest or increased frequency and duration of anginal attacks. In most cases, it is common due to rupture of an atheromatous plaque and platelet deposition in the coronary artery, leading to progressive thrombosis.
3. **Prinzmetal's angina (variant angina):** Angina that occurs at rest and is due to spasm of coronary arteries.

Pathophysiology

Angina occurs due to imbalance in oxygen supply and demand by the myocardium.

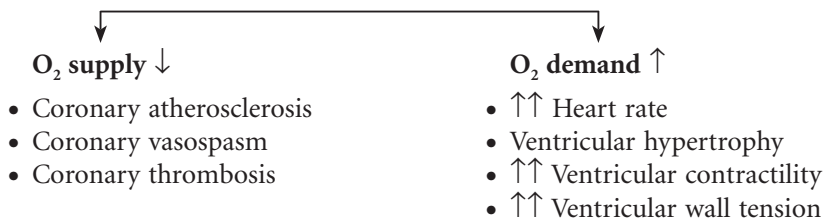

Treatment

Treatment is aimed at maintaining the balance between O₂ supply and demand.

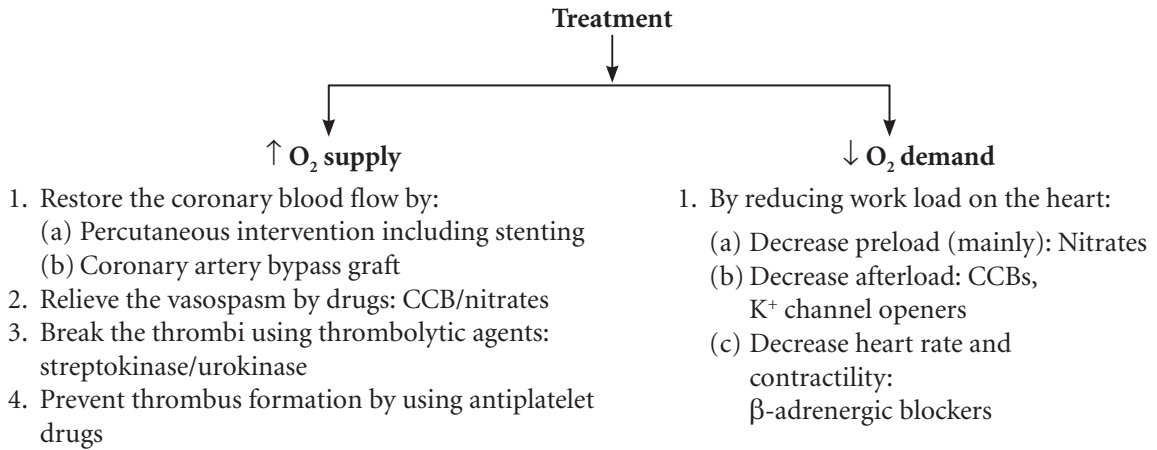

Classification

- Nitrates:** Nitroglycerin (glyceryl trinitrate), isosorbide dinitrate, isosorbide mononitrate, erythryl tetranitrate.
- β-Adrenergic blockers:** Propranolol, metoprolol, atenolol.
- Calcium channel blockers (CCBs):** Verapamil, diltiazem, nifedipine SR, felodipine, amlodipine, nitrendipine, nimodipine.
- Potassium channel opener:** Nicorandil.
- Others*:** Antiplatelet agents, (low-dose aspirin, clopidogrel), Statins, Trimetazidine, Ranolazine.

Organic Nitrates

Organic nitrates are prodrugs—they release nitric oxide (NO). Nitrates are mainly venodilators, also cause arteriolar dilatation, therefore, reduce both preload and afterload.

Mechanism of action

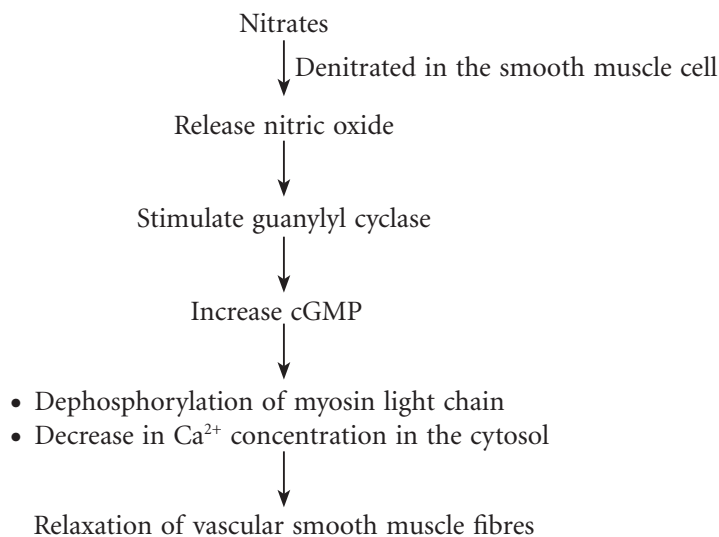

* Mnemonic: STAR

Pharmacological actions of nitrates

Nitroglycerin is the prototype drug. Nitrates have no direct action on the heart.

1. **On vascular smooth muscle:** Nitroglycerin quickly relieves anginal pain by decreasing the O_2 requirement and increasing the O_2 delivery to the myocardium.

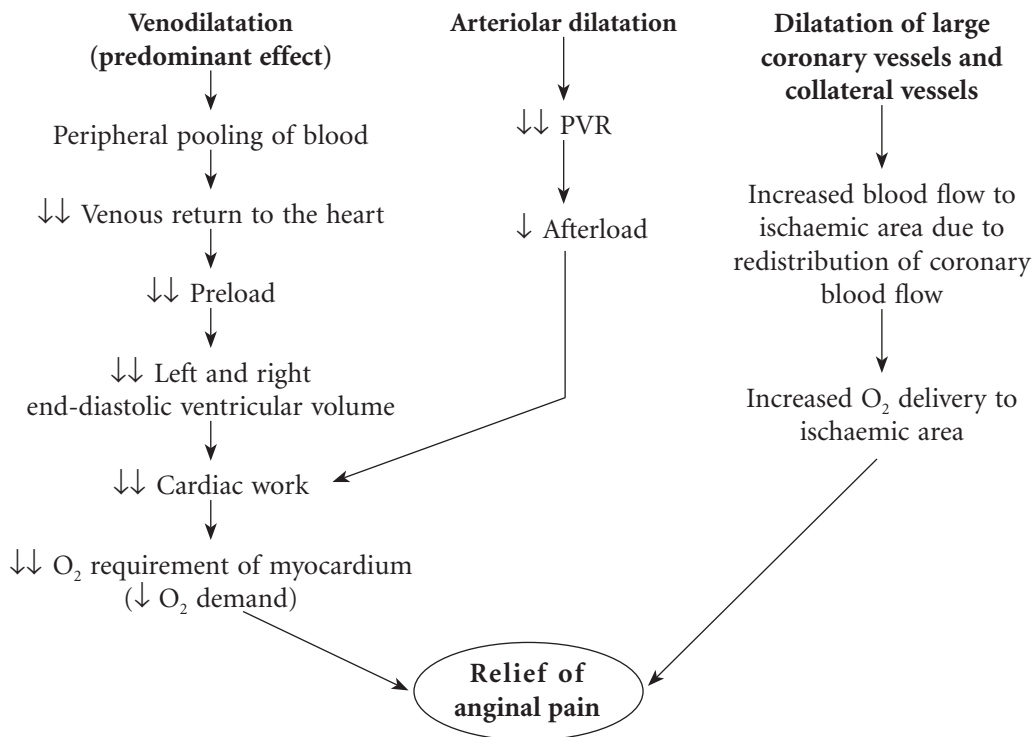

2. **On other smooth muscles:** Smooth muscles of the bronchi, oesophagus, biliary tract, etc. are relaxed by nitrates.

Pharmacokinetics

Organic nitrates are readily absorbed through the buccal mucous membrane, the skin and gastrointestinal (GI) tract. All nitrates except isosorbide mononitrate undergo extensive first-pass metabolism; hence, oral bioavailability of nitrates is very low. Sublingual route produces rapid onset (2–5 min) but short duration of action. Absorption through skin is slow; hence, transdermal route is used for a prolonged effect. The metabolites are excreted mainly in urine as glucuronide derivatives.

Adverse effects

Adverse effects are due to extensive vasodilatation. They are headache, postural hypotension, tachycardia, palpitation, weakness, flushing and rarely syncope. To avoid these symptoms, the tablet may be spit out as soon as the pain is relieved. Overdosage may cause methaemoglobinaemia.

Tolerance

Tolerance to nitrates occurs on prolonged use. They also exhibit cross-tolerance.

Isosorbide dinitrate: It can be used sublingually for acute anginal attack and orally for chronic prophylaxis. Its oral bioavailability is low because of first-pass metabolism.

Isosorbide mononitrate: It is preferred over dinitrate for chronic prophylaxis of angina, because it has (Table 4.5):

- a. Longer duration of action.
- b. High oral bioavailability as it does not undergo first-pass metabolism.

Therapeutic Uses of Nitrates

Table 4.5 Nitrates Used in the Treatment of Angina

Drug	Dosage	Duration of action
Glyceryl trinitrate (GTN; nitroglycerin)	<ul style="list-style-type: none"> • 0.5 mg (500 mcg) sublingual • 0.4 mg (400 mcg) lingual spray • 5–10 mg transdermal patch 	<ul style="list-style-type: none"> • 10–30 minutes • 10–30 minutes • Up to 24 hours <p>Transdermal patch should be removed for few hours each day to avoid the development of tolerance</p>
Isosorbide dinitrate	<ul style="list-style-type: none"> • 2.5–10 mg sublingual • 5–40 mg oral 	<ul style="list-style-type: none"> • 20–60 minutes • 6–8 hours
Isosorbide mononitrate	20–40 mg oral	6–10 hours
Erythryl tetranitrate	20–40 mg oral	4–6 hours

1. Angina (for mechanism of action see p. 110–111)

For acute attack of angina

- Nitroglycerin is the drug of choice. For an acute attack, nitroglycerin is commonly administered sublingually with an initial dose of 0.5 mg, which usually relieves pain in 2–3 min. Patient is advised to spit out the tablet as soon as the pain is relieved to avoid side effects (hypotension and headache). If the pain is not relieved, the tablet can be repeated after 5 min; but not more than three tablets in 15 min. Nitroglycerin undergoes extensive first-pass metabolism when swallowed. Nitroglycerin buccal spray can also be used for acute attack of angina.
- Isosorbide dinitrate (sublingual) can also relieve acute attack of angina.

For prophylaxis of angina

Nitrates decrease the frequency of anginal attacks. Longer-acting nitrate preparations are used—either isosorbide mononitrate (oral) isosorbide dinitrate (oral) or nitroglycerin (oral sustained-release preparation/ointment/disc/patch). Transdermal nitroglycerin produces prolonged effect (up to 24 h). To avoid tolerance, the patch should be removed for a few hours (at least 8 h). Oral nitrates are used for long-term prophylaxis of angina pectoris. They decrease the frequency of anginal attacks and improve exercise tolerance. Sublingual nitroglycerin may be used prophylactically, immediately before exercise or stress. The main disadvantage with long-term use of nitrates is development of tolerance, which can be minimized by a nitrate free interval of 8–10 h/day.

2. **Variant angina** (Prinzmetal's angina): It is due to coronary vasospasm. Episodes of coronary vasospasm are treated with nitrates; for prophylaxis, nitrates and calcium channel blockers (amlodipine, nifedipine SR and diltiazem) are effective. Addition of a CCB with nitrate produces better efficacy in variant angina; also, the incidence of MI is reduced.
3. **Unstable angina:** It requires treatment with multiple drugs—antiplatelet agents, anticoagulants, nitrates, β -blockers, CCBs and statins.
4. **Myocardial infarction:** For management of acute MI see p. 117.

5. **Congestive cardiac failure:** The role of nitrates in CCF is discussed in pp. 119 and 120, see Fig. 4.10.
6. **Biliary colic:** Sublingual nitroglycerin can be used to relieve biliary spasm and associated pain.
7. **Cyanide poisoning:** Cyanide inhibits cytochrome oxidase and prevents oxygen utilization by the cells. Administration of sodium nitrite followed by sodium thiosulphate results in the formation of sodium thiocyanate, which is rapidly excreted in urine.

β-Adrenergic Blockers

The beneficial effects of β-blockers in exertional angina are mainly due to negative chronotropic and negative inotropic effects.

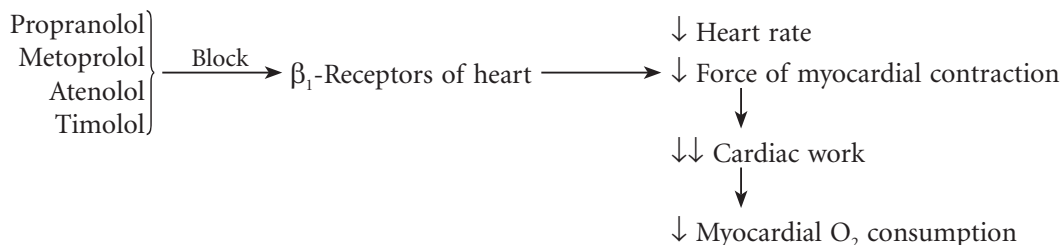

β-Blockers have slow onset of action and are useful in anginal prophylaxis. β-Blockers improve exercise tolerance and reduce the frequency of anginal episodes. Use of β-blocker (those without intrinsic sympathomimetic activity) decreases mortality in patients with recent MI; hence, it should be started early and continued indefinitely.

Adverse effects

They include bradycardia, heart block, bronchospasm in patients with bronchial asthma, etc. (see p. 93).

β-Blockers can increase left ventricular end-diastolic volume, which can be counteracted by combining them with nitrates.

β-blockers should not be withdrawn abruptly because this may precipitate dangerous arrhythmias or myocardial infarction (for details see pp. 27 and 93).

Calcium Channel Blockers (CCB)

1. **Phenylalkylamine:** Verapamil.
2. **Benzothiazepine:** Diltiazem.
3. **Dihydropyridines:** Nifedipine SR, amlodipine, nifedipine, felodipine.

Mechanism of action

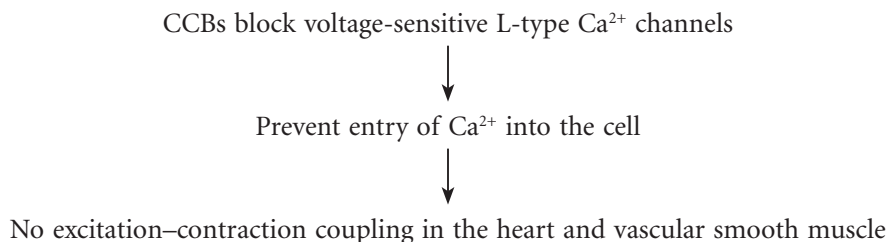

Pharmacological actions

Calcium channel blockers act mainly on cardiac and smooth muscles. They have little action on veins and hence do not alter preload.

1. **Verapamil:** It is a phenylalkylamine and has predominant action on heart. It:
 - Decreases force of contraction (negative inotropic effect) and decreases heart rate (negative chronotropic effect). This reduces oxygen requirement of the myocardium.
 - Depresses S–A node and slows A–V conduction (negative dromotropic effect) by prolonging effective refractory period.
 Verapamil is a less potent coronary and peripheral vasodilator than the DHPs.
2. **Diltiazem:** It dilates peripheral and coronary arteries; but its vasodilating property is less marked than DHPs. It also causes negative inotropic, chronotropic and dromotropic effects. It is used in the treatment of angina, hypertension and supraventricular arrhythmias.
3. **Dihydropyridines (DHPs):** These are potent arteriolar dilators and reduce peripheral vascular resistance. Higher doses are required for significant cardiac effects—cardiac-depressant effect is less than verapamil and diltiazem.

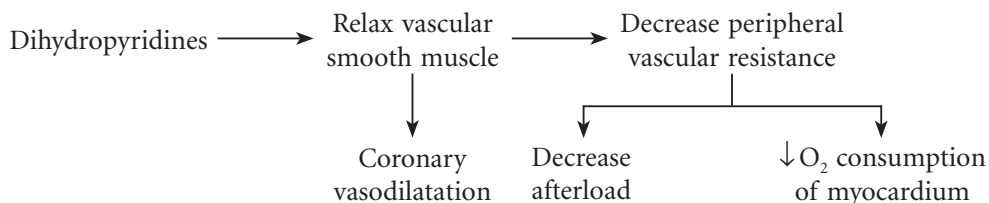

- a. **Nifedipine:** It is the prototype drug. It has a predominant action on vascular smooth muscle. Reflex tachycardia and palpitation are commonly seen with nifedipine. This can be minimized by using sustained-release preparation or counteracted by adding a β -blocker.
 - b. **Amlodipine:** It is absorbed slowly after oral administration, but its bioavailability is high. It is more potent and has a longer duration of action than nifedipine. It dilates both peripheral as well as coronary vessels. Palpitation and reflex tachycardia are rare with amlodipine because of its long half-life. It is mainly used in angina and hypertension. The common side effects are headache and ankle oedema.
 - c. **Nicardipine:** Its antianginal effects are similar to nifedipine.
 - d. **Nimodipine:** It has high lipid solubility, freely crosses BBB and selectively dilates cerebral blood vessels. It is used to prevent cerebral vasospasm and subsequent neurological defects in patients with subarachnoid haemorrhage.
- Felodipine, isradipine and nisoldipine** are other DHPs with long duration of action.

Pharmacokinetics

All calcium channel blockers are well absorbed through GI tract but undergo varying degree of first-pass metabolism. All are highly bound to plasma proteins, metabolized in liver and excreted in urine.

Adverse effects of CCBs have been listed in Table 4.6.

Uses of CCBs

1. **Exertional angina** (for detailed explanation, see pharmacological action): The beneficial effect in angina pectoris with CCBs is mainly due to a decrease in myocardial O_2 consumption (following \downarrow HR, \downarrow force of contraction or \downarrow afterload) and dilatation of coronary arteries. Diltiazem, verapamil, and DHPs (amlodipine, nifedipine SR and nicardipine) are used in stable angina. Diltiazem and verapamil produce less reflex tachycardia. Diltiazem is preferred over verapamil as it has fewer side

Table 4.6 Adverse Effects of Calcium Channel Blockers

Nifedipine	Verapamil	Diltiazem
<ul style="list-style-type: none"> • Postural hypotension • Palpitation • Reflex tachycardia • Oedema • Flushing • Fatigue • Dizziness • Sedation 	<ul style="list-style-type: none"> • Constipation • Sinus bradycardia • Oedema, may precipitate CCF in patients with low cardiac reserve • A–V block and headache rarely 	<ul style="list-style-type: none"> • Headache • Hypotension • Bradycardia • Oedema • A–V block occurs rarely

effects. DHPs like nifedipine and felodipine may aggravate anginal symptoms because of reflex tachycardia, which can be counteracted by combining them with β -blockers.

2. **Variant angina:** It is due to coronary spasm. Amlodipine, nifedipine SR and diltiazem can be used prophylactically. They relieve pain effectively by attenuating the coronary vasospasm.
3. **Unstable angina:** Calcium channel blockers are used mainly when symptoms are not relieved by nitrates and β -blockers or if these drugs are contraindicated.
4. **Supraventricular arrhythmias:** Verapamil is the preferred drug for supraventricular arrhythmias because of its depressant action on S–A and A–V nodes. Diltiazem is also useful but is less effective than verapamil.
5. **Hypertension:** DHPs, diltiazem and verapamil are used in hypertension (see p. 102). They control blood pressure by their vasodilatory effect. They can be safely used in hypertensive patients with asthma, hyperlipidaemia and renal dysfunction.
6. **Migraine:** Verapamil is useful for the prophylaxis of migraine.
7. Nimodipine is used for prevention and treatment of cerebral vasospasm and subsequent neurological defects in patients with **subarachnoid haemorrhage**.

► Potassium Channel Opener (Potassium Channel Activator)

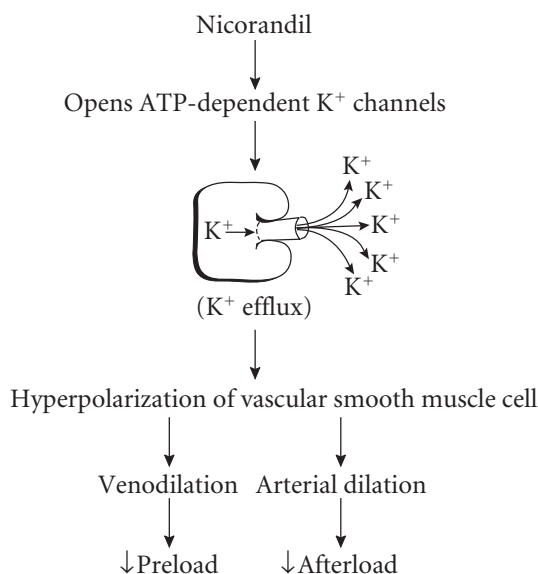

Nicorandil is administered orally. Tolerance does not develop to its actions. The side effects are headache, hypotension, palpitation, flushing, nausea and vomiting.

Other Drugs

Antiplatelet agents like aspirin (low dose 81–325 mg daily) or clopidogrel are used.

Ranolazine and trimetazidine are used along with conventional antianginal drugs in stable angina.

Combination Therapy

1. **Nitrates × β -blockers (Propranolol):** This combination increases the effectiveness and reduces the incidence of adverse effects (Fig. 4.6).
 - a. Nitrates can counteract the increase in left ventricular end-diastolic volume associated with propranolol.
 - b. Nitrates → arterial dilatation → ↓ PVR → reflex tachycardia. Propranolol can block the reflex tachycardia that is associated with nitrates.
 - c. Nitrates can block coronary spasm associated with β -blockers.

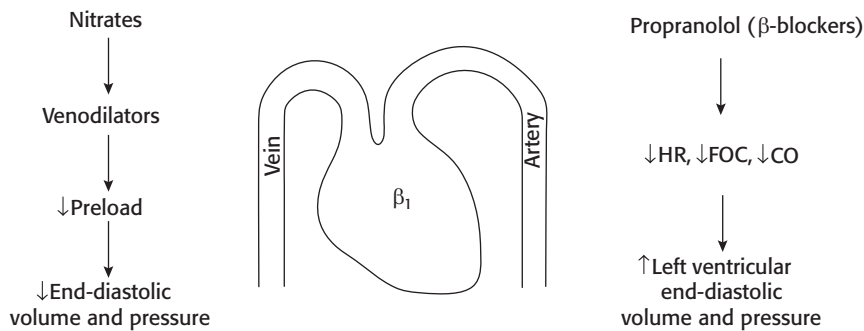

Fig. 4.6 Effects of nitrates × β -blockers (propranolol).

2. **Nifedipine (DHPs) × β -blockers:** β -Blockers can block the reflex tachycardia that is associated with nifedipine (Fig. 4.7).

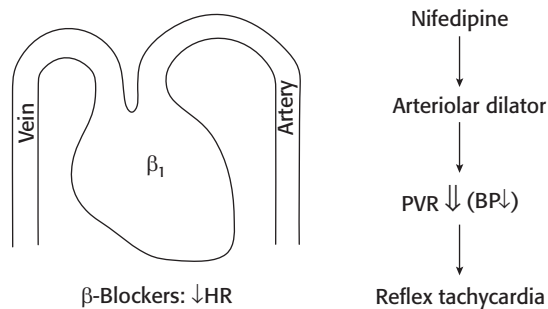

Fig. 4.7 Effects of nifedipine (DHPs) × β -blockers.

3. **β -blockers × verapamil/diltiazem:** This combination may cause additive depressant effect on S–A node, A–V node and cardiac contractility leading to heart block, heart failure or even cardiac arrest.

4. **Calcium channel blockers × nitrates:** The net effect is an additive reduction in the myocardial O₂ demand (Fig. 4.8).

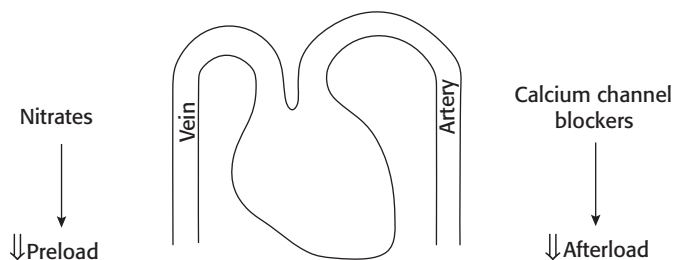

Fig. 4.8 Effects of calcium channel blockers × nitrates.

Pharmacotherapy of Acute Myocardial Infarction

1. **Nitrates:** Sublingual nitroglycerin (0.5 mg)—not more than 3 tablets in 15 min; for recurrent or persistent pain intravenous nitroglycerine is used.
2. **Antiplatelet agent:** Aspirin 162 mg or 325 mg orally (chewed and swallowed) in patient with suspected or definite MI. Clopidogrel 300 mg is also administered. Antiplatelet agent should be continued.
3. **Analgesia:** Opioid analgesic (morphine or pethidine) to relieve pain.
4. **Reperfusion therapy:** Thrombolytic therapy or primary percutaneous coronary intervention (PCI) to restore coronary patency and reperfusion of infarcted area.
5. **Anticoagulants:** Low-molecular-weight heparin or unfractionated heparin is given to prevent reinfarction and thromboembolic complications.
6. **Other drugs** used are β -blockers (e.g. metoprolol), ACE inhibitors (e.g. ramipril) or angiotensin-receptor blockers (e.g. valsartan) and statins (e.g. atorvastatin).

Key Points for Dentists

- For an acute attack of angina, nitroglycerin is commonly administered sublingually with an initial dose of 0.5 mg that usually relieves pain in 2–3 min. Patient is advised to spit out the tablet as soon as the pain is relieved to avoid the side effects (hypotension and headache). If the pain is not relieved, the tablet can be repeated after 5 min; but not more than 3 tablets in 15 min.

DRUGS USED IN CONGESTIVE CARDIAC FAILURE

The function of the heart is to pump an adequate amount of blood to various tissues. In CCF, there is an inadequate or inefficient contraction of the heart leading to reduced cardiac output (CO). In initial stages of CCF, the compensatory mechanisms that try to maintain the cardiac output (Fig. 4.9) are:

- Increased sympathetic activity.
- Increased renin–angiotensin–aldosterone activity.
- Myocardial hypertrophy and remodelling.

As time progresses, the compensatory mechanisms fail and gradually clinical symptoms of failure appear. The basic haemodynamic disturbances seen in congestive cardiac failure are:

- Increased pulmonary capillary pressure termed as backward failure, which is characterized by dyspnoea and orthopnoea.

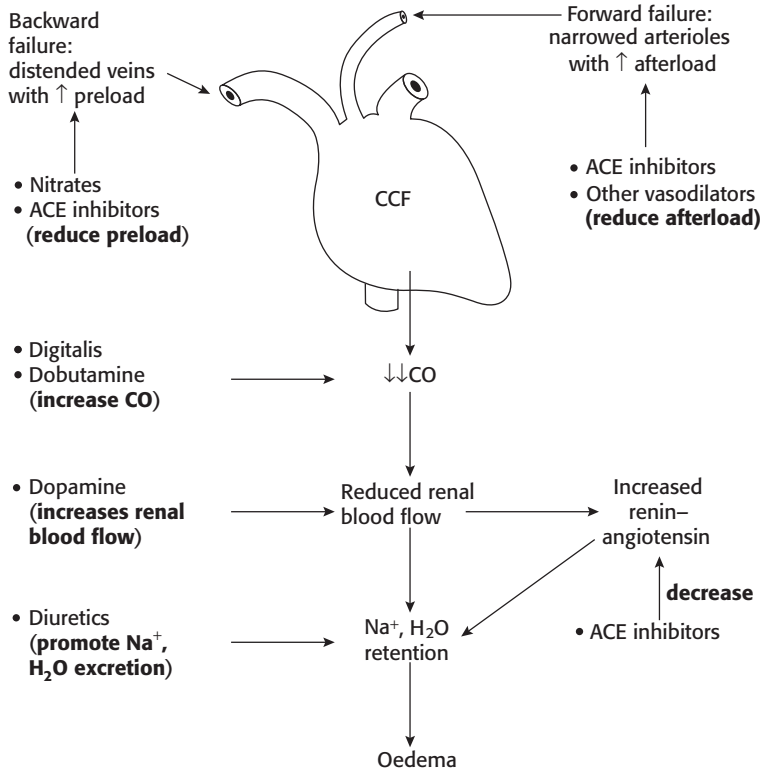

Fig. 4.9 Pathophysiology of CCF and mechanism of action of some drugs used in its treatment. ARBs, angiotensin receptor blockers; CCF, congestive cardiac failure; CO, cardiac output.

- Decreased cardiac output termed as forward failure, leading to decreased oxygen supply to the peripheral tissues (tissue hypoxia).

The main aim in the management of cardiac failure is to provide endogenous support to the failing heart and to reduce the work load placed on the heart. The treatment strategies for CCF include preload reduction, afterload reduction and enhancement of contractile state of the heart.

Classification

1. Diuretics

- Loop diuretics*: Furosemide, bumetanide.
- Thiazide diuretics*: Chlorothiazide, hydrochlorothiazide.
- Aldosterone antagonist*: Spironolactone.

2. Vasodilators

- Arteriolar and venodilators*
 - ACE inhibitors: Enalapril, lisinopril, ramipril.
 - Angiotensin-receptor blockers (ARBs): Losartan, candesartan.
 - Sodium nitroprusside
- Venodilators*: Nitroglycerin, isosorbide dinitrate.
- Arteriolar dilators*: Hydralazine.

3. **β -Adrenergic blockers:** Metoprolol, bisoprolol, carvedilol.
4. **Sympathomimetic amines:** Dopamine, dobutamine.
5. **Cardiac glycosides:** Digoxin.
6. **Phosphodiesterase inhibitors:** Inamrinone, milrinone.

Diuretics

Thiazides are used in mild-to-moderate cardiac failure. They inhibit $\text{Na}^+\text{-Cl}^-$ symport in the early distal tubule. Thiazides are not effective if the glomerular filtration rate (GFR) falls <30 mL/min. Loop diuretics (furosemide and bumetanide) inhibit $\text{Na}^+\text{-K}^+\text{-2Cl}^-$ cotransport, mainly in the thick ascending limb of the loop of Henle. Loop diuretics are used in severe cardiac failure, pulmonary oedema and refractory heart failure. Hypokalaemia induced by thiazides and loop diuretics is prevented by combining them with a potassium-sparing diuretic or giving oral potassium supplement. Spironolactone is an antagonist of aldosterone that is often used in heart failure.



Vasodilators

The vasodilators may be classified according to the distribution of their effect (Fig. 4.10):

1. **Mixed arteriolar and venodilators:** ACE inhibitors, ARBs, sodium nitroprusside (reduce both preload and afterload).
2. **Drugs with predominant venodilatory effect:** Nitrates (reduce preload, also have some effect on arterioles).
3. **Drug with predominant arteriolar dilating effect:** Hydralazine (reduces afterload).

The disadvantages with the use of arteriolar dilators are reflex tachycardia and fluid retention. Tachycardia is rare with mixed arteriolar and venodilators.

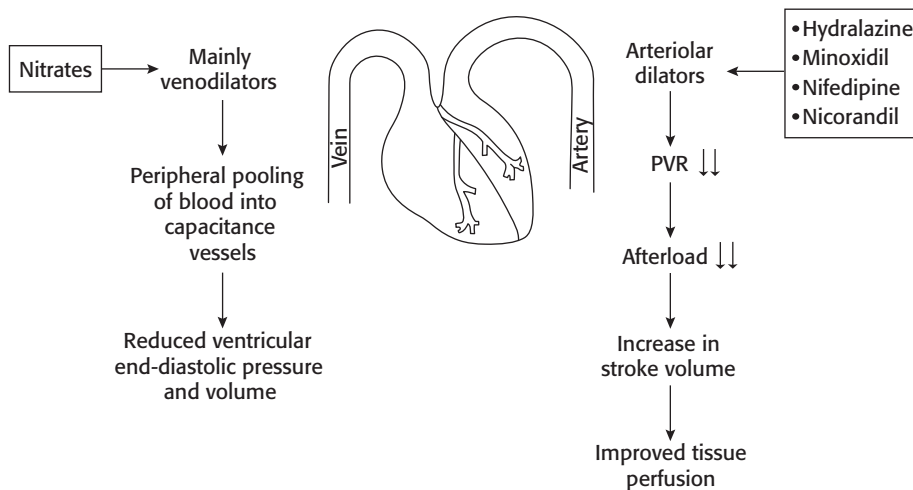

Note: ACE inhibitors, ARBs, sodium nitroprusside reduce both preload and afterload.

Fig. 4.10 Effects of vasodilators in congestive cardiac failure.

ACE Inhibitors

These are the first-line drugs in the treatment of chronic heart failure. They inhibit conversion of angiotensin-I to angiotensin-II. ACE inhibitors inhibit the generation of angiotensin II resulting in the following:

- Decrease in peripheral vascular resistance (PVR) → increase in stroke volume → improved tissue perfusion.
- Decrease in aldosterone production → decrease in sodium and water retention → ↓preload.
- Venodilation → ↓preload.
- Retard/reverse cardiac hypertrophy and remodelling.

For mechanism of action, adverse effects and contraindications (see pp. 99–100).

Angiotensin-receptor Blockers (ARBs) (see p. 101)

Losartan, candesartan, etc. competitively block AT_1 -receptors on the heart, peripheral vasculature and kidney. They prevent the effects of angiotensin II and produce effects similar to those of ACE inhibitors. ARBs are mainly used in patients who cannot tolerate ACE inhibitors because of cough, angioedema and neutropaenia.

Sodium nitroprusside (i.v.) and **nitroglycerin** (i.v.) are used for severe heart failure.

Hydralazine, an arteriolar dilator, increases cardiac output in patients with heart failure.

β-Blockers

β-Blockers like metoprolol, bisoprolol and carvedilol are useful in mild-to-moderate heart failure. Long-term therapy with these β-blockers improves symptoms, reduces hospitalization and decreases mortality in patients with mild-to-moderate heart failure. The exact mechanism of action is not clear. They block β-receptor-mediated effects of catecholamines on the heart. This improves left ventricular (LV) structure and function, increases ejection fraction and decreases LV size. They also decrease frequency of arrhythmias. The antioxidant effect of carvedilol also contributes to its beneficial effects. Therapy with β-blockers in heart failure should be under careful supervision.

Cardiac Glycosides

Chemistry

The glycosides consist of an aglycone (steroid nucleus with an attached lactone ring) with one or more sugar moieties attached to it. These have a potent action on the heart, hence referred to as cardiac glycosides.

Source	Glycosides
<i>Digitalis purpurea</i> (leaf)	Digitoxin
<i>Digitalis lanata</i> (leaf)	Digoxin, digitoxin

The utility of digitalis in the treatment of heart failure was shown by William Withering.

Mechanism of action of cardiac glycosides (Digitalis; Fig. 4.11)

Na^+K^+ -ATPase is a membrane-bound enzyme, which is called digitalis receptor. It is also called sodium pump.

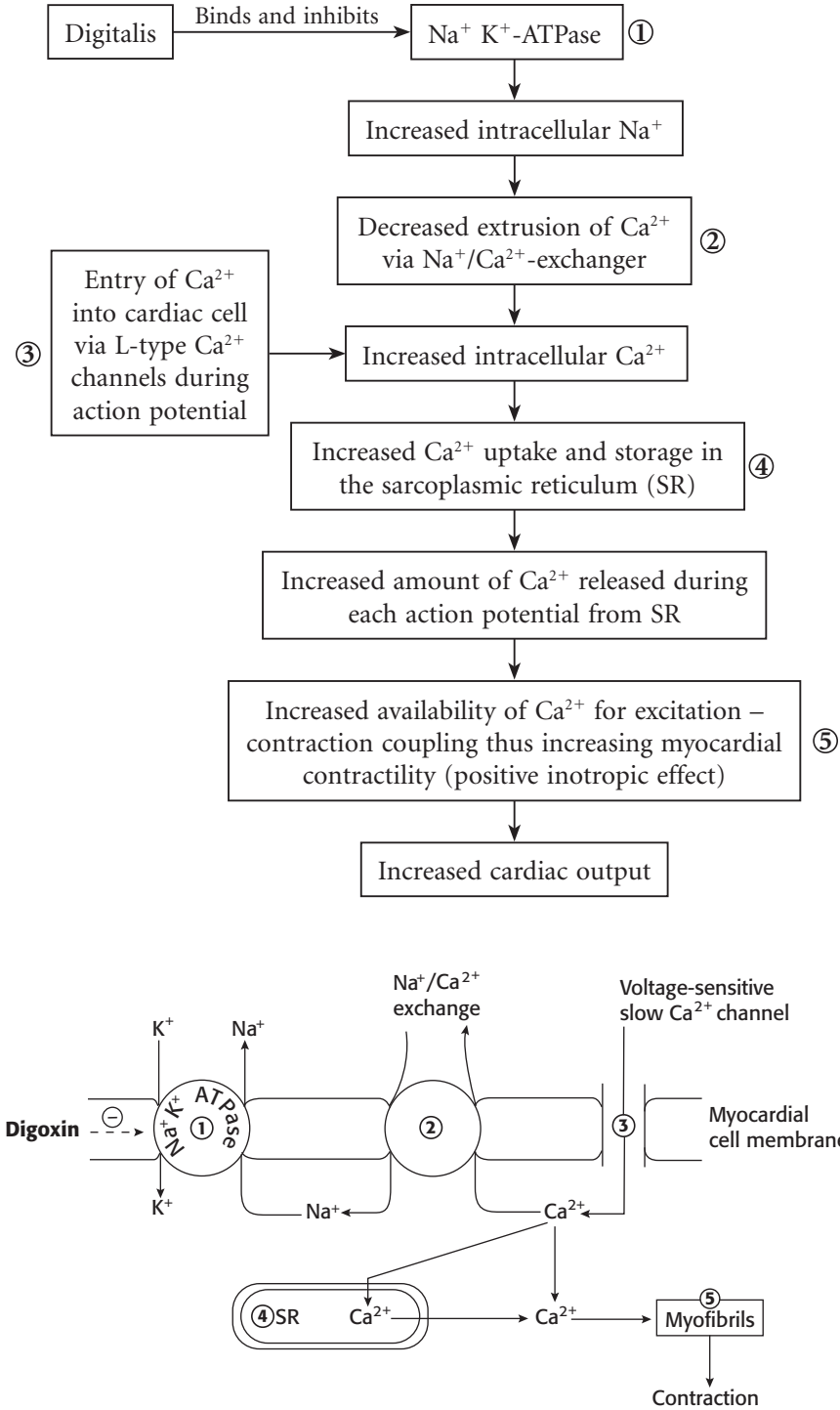

Fig. 4.11 Mechanism of action of cardiac glycosides: SR, sarcoplasmic reticulum.

Pharmacological actions

1. Cardiac
2. Extracardiac

Cardiac actions

Digitalis has direct and indirect actions on the heart.

- Direct action by inhibiting $\text{Na}^+ \text{K}^+ \text{-ATPase}$.
 - Indirect action by stimulating vagus (vagomimetic effect).
1. **Myocardial contractility:** Digitalis increases the force of contraction of the myocardium (positive inotropic effect). This effect is more prominent in the failing heart. Digitalized heart contracts more forcibly and completely. The positive inotropic effect causes complete emptying of the ventricles during systole and increases the cardiac output. This decreases pulmonary congestion and systemic venous pressure. The diastolic size of the heart is reduced. When the size of the heart is reduced, muscle fibre length is also reduced, thereby, decreasing the oxygen requirement of myocardium. The digitalized heart, thus, can do more work for the same energy. Therefore, digitalis is called a 'cardiotonic'.
 2. **Heart rate:** In patients with CCF, digitalis reduces the heart rate (negative chronotropic effect) by direct and indirect actions. In small doses, digitalis decreases heart rate by stimulation of vagus. In toxic doses, it can increase sympathetic activity and thus increases heart rate.
 3. **Electrophysiological actions:** At therapeutic concentrations, digoxin decreases automaticity and increases resting membrane potential by vagal action in atria and A–V node. This may lead to bradycardia and A–V block. At higher concentrations, digoxin can increase automaticity in cardiac tissue. This can result in atrial and ventricular arrhythmias.

Extracardiac

1. **Gastrointestinal tract (GIT):** Digitalis can produce anorexia, nausea and vomiting. Nausea and vomiting is due to stimulation of chemoreceptor trigger zone (CTZ) and a direct action on the gut.
2. **Kidney:** In patients with CCF, digitalis causes diuresis (increased urine output).
3. **Central nervous system (CNS):** In high doses, it can cause central sympathetic stimulation, confusion, blurring of vision, disorientation, etc.

Pharmacokinetics

Digoxin is the commonly used glycoside and is usually administered by oral route; food delays the absorption of digoxin. It is widely distributed in the body; concentrated in the heart, liver, kidney and skeletal muscle. It crosses the BBB and is mainly excreted unchanged in urine. Dosage adjustment of digoxin is necessary in patients with renal failure.

Adverse effects

Digoxin has a narrow margin of safety. Monitoring of serum digoxin, electrolyte levels and electrocardiogram (ECG) are important during digitalis therapy.

1. **Extracardiac:**
 - i. **GIT:** Early symptoms of toxicity are anorexia, nausea and vomiting, which are due to GI irritation and CTZ stimulation.

- ii. CNS effects include headache, confusion, restlessness, disorientation, weakness, visual disturbances, altered mood and hallucinations.
 - iii. *Skin rashes and gynaecomastia* can occur occasionally.
2. **Cardiac:** Digitalis can cause any type of arrhythmias. The most common are ventricular premature beats and ventricular tachycardia. It can also cause A–V block, atrial tachycardia, atrial fibrillation, atrial flutter and even severe bradycardia.

Factors affecting digitalis toxicity:

1. Age: Elderly patients are more susceptible to digitalis toxicity due to declining renal and hepatic functions.
2. Route: Intravenous digitalization carries more risk than oral route.
3. Hypokalaemia increases the binding of digoxin to Na⁺ K⁺-ATPase and enhances its toxicity.
4. Hypercalcaemia and hypomagnesaemia enhance digoxin toxicity.
5. Hypothyroidism, hyperthyroidism, hypoxia, renal failure and myocarditis are predisposing factors to digitalis toxicity.

Treatment of digoxin toxicity:

1. Shift the patient to coronary care unit (CCU).
2. Stop digoxin and potassium-depleting diuretics (thiazides/loop diuretics).
3. Potassium chloride (KCl) orally or intravenously is the drug of choice for tachyarrhythmias, even when the serum K⁺ level is normal.
4. Supraventricular arrhythmias are treated with oral or intravenous propranolol.
5. Intravenous lignocaine is the drug of choice for ventricular arrhythmias because it has:
 - Relatively low incidence of toxicity.
 - A rapid onset and short duration of action, so its action wears off immediately after stopping the infusion.
 - No action on A–V nodal conduction velocity; hence, it does not intensify the A–V block in digitalis toxicity.
6. A–V block and bradyarrhythmias are treated with atropine and cardiac pacing.
7. Digoxin antibodies (Digibind): It is used only in case of serious digitalis toxicity. It neutralizes circulating digoxin/digitoxin and rapidly reverses the toxicity, but it is expensive.

Drug interactions

1. **β-Blocker/verapamil × digoxin:** These drugs have additive depressant effect on S–A and A–V nodes and may precipitate A–V block.
2. **Thiazides/loop diuretics × digoxin:** Hypokalaemia caused by diuretics may potentiate digoxin toxicity. Hypokalaemia increases the binding of digoxin to Na⁺ K⁺-ATPase.

Uses of digitalis

1. **CCF:** Digitalis is useful in patients with low-output failure especially when associated with atrial fibrillation. It is ineffective in high-output failure associated with severe anaemia, thyrotoxicosis and A–V shunt.

The beneficial effects of digoxin in case of heart failure are due to its action on (Fig. 4.12):

- Myocardium (positive inotropic effect): For explanation, see under pharmacological actions.
- Venous system.
- Kidney.

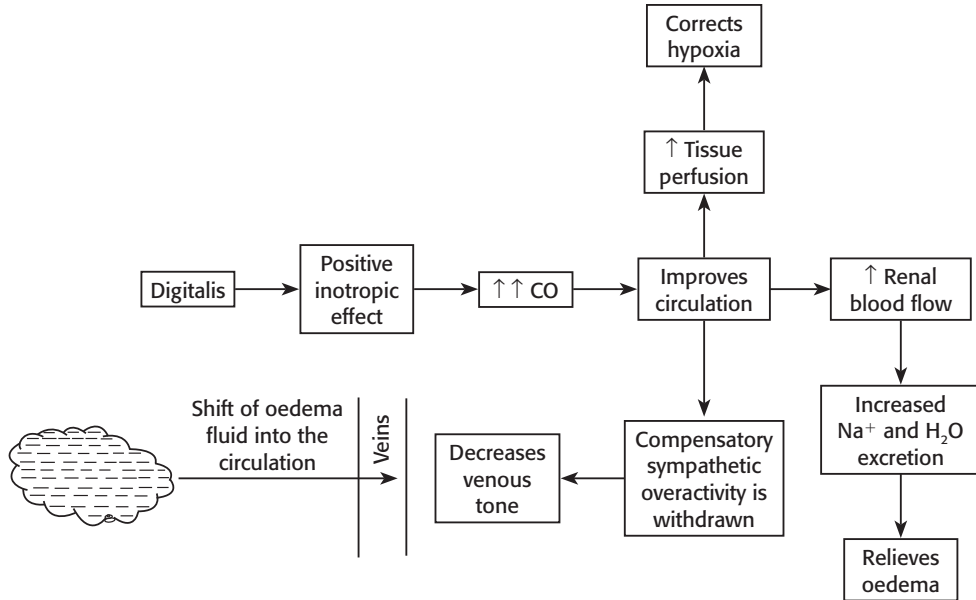

Fig. 4.12 Beneficial effects of digitalis in CCF. CO, cardiac output.

- 2. Cardiac arrhythmias:** Digoxin can be used in atrial fibrillation, atrial flutter, etc.

■ Sympathomimetic Amines

Dopamine and dobutamine are used in acute heart failure; they provide symptomatic relief in patients with ventricular dysfunction.

► Dopamine

It is a catecholamine and has dose-dependent haemodynamic effects. At low doses, dopamine selectively dilates renal, mesenteric and coronary blood vessels by acting on D_1 -receptors. Thus, dopamine increases GFR and urine output. At moderate doses (2–5 mcg/kg/min), dopamine stimulates β_1 -receptors of heart, increases myocardial contractility and cardiac output, but tachycardia is less prominent. It also stimulates dopaminergic receptors resulting in an increase in GFR. Dopamine is used in cardiogenic shock and acute heart failure with renal impairment. It improves both cardiac and renal function. At high concentration (≥ 10 mcg/kg/min), it causes generalized vasoconstriction. This increases afterload and reduces blood flow to renal, mesenteric and other vital organs. So the beneficial effects seen with low-to-moderate doses of dopamine are lost at higher concentrations.

► Dobutamine

It is a synthetic catecholamine and acts on β_1 -, β_2 - and α_1 -receptors. It has selective inotropic effect and increases cardiac output. In therapeutic doses, it has little effect on BP and heart rate (see p. 84). Total peripheral resistance is generally not affected. It is administered by i.v. infusion for short-term treatment of acute heart failure (due to MI or cardiac surgery) and cardiogenic shock. The side effects are tachycardia, rise in BP and development of tolerance.

■ Phosphodiesterase Inhibitors

Inamrinone and milrinone are selective phosphodiesterase III inhibitors and increase cAMP level. They exert both positive inotropic and vasodilator actions. They are administered intravenously. They are used for short-term treatment of severe heart failure. The adverse effects of inamrinone include nausea, vomiting, arrhythmias, thrombocytopenia and hepatotoxicity. Milrinone is more potent than inamrinone and does not produce thrombocytopenia.

Key Points for Dentists

- Diuretics (thiazides, loop diuretics) cause hyponatraemia, especially in elderly patients.
- Thiazides and loop diuretics can cause hypokalaemia.
- Monitor serum potassium in patients who are on diuretics and digoxin. Hypokalaemia can enhance digoxin toxicity.
- Monitor patients on digoxin for toxicity. Patients should be advised to report if they develop nausea, vomiting, visual disturbances, etc.

PLASMA EXPANDERS

Plasma expanders are colloidal solutions used for temporary maintenance of blood volume in emergency situations. Colloidal solutions have a high molecular weight and exert a greater oncotic pressure. The important colloidal solutions are human albumin, dextran, polyvinylpyrrolidone, hetastarch and degraded gelatin polymer. Crystalloid plasma expanders include normal saline, hypertonic saline, 5% dextrose, etc.

Requirements of an ideal plasma expander are:

1. The oncotic pressure, pH and viscosity of the solution should be same as that of plasma.
2. It should be retained in the circulation for an adequate period.
3. It should be non-pyrogenic and non-antigenic.
4. It should be stable and cheaper.
5. It should not interfere with blood grouping and cross-matching of blood.

Human albumin: Albumin and plasma protein fraction, which are prepared from pooled human plasma, are the commonly used plasma expanders. They do not carry the risk of hepatitis. They are valuable to restore colloidal osmotic pressure in hypovolaemic states such as burns, haemorrhage and surgical procedures. They can cause hypersensitivity and overloading of circulation. Plasma protein fraction contains globulin in addition to albumin.

Dextran: Dextran is a water-soluble glucose polymer produced by bacteria grown on sucrose media. It is available as dextran 40 and dextran 70. Dextrans increase plasma colloidal oncotic pressure similar to that of plasma proteins. They are administered as i.v. infusion. Dextran 70 has a longer duration of action because of its slow renal excretion.

Dextrans may interfere with blood grouping and cross-matching, platelet function and coagulation. The adverse effects are hypersensitivity, fever, joint pain, urticaria, hypotension, bronchospasm and rarely anaphylactic reaction. The anticoagulant effect of heparin may be enhanced by dextran.

Hydroxyethyl starch or hetastarch: It is derived from starch. It acts by increasing oncotic effect similar to that of plasma albumin. It has a long duration of action.

It does not interfere with blood grouping and cross-matching of blood. The adverse effects are flu-like syndrome (headache, fever and myalgia), itching, urticaria and anaphylactoid reactions.

Degraded gelatin polymer: Gelatin is a polypeptide obtained from ox collagen. Gelatin in degraded form is used commonly as a plasma expander. It exerts oncotic pressure similar to that of albumin. Plasma expansion lasts for about 12 h. It does not interfere with blood grouping and cross-matching of blood. Gelatin has also been used as a haemostatic in surgical procedures. It can cause hypersensitivity—flushing, itching, urticaria, bronchospasm and hypotension. Severe reactions can occur with urea-linked gelatin, e.g. haemaccel.

Polyvinylpyrrolidone: This is a synthetic polymer. It interferes with blood grouping and cross-matching of blood. It binds to drugs, such as insulin and penicillin in circulation and reduces their effect. It is rarely used now.

Uses of plasma expanders

They are used to restore colloidal oncotic pressure in hypovolaemic states like burns, haemorrhage, surgical procedures, severe trauma, etc.

Contraindications

They are severe anaemia, bleeding disorders, congestive heart failure, renal failure and hepatic failure.

Key Points for Dentists

- Dextran, human albumin, degraded gelatin, etc. can cause hypersensitivity reactions.
- Care should be taken to prevent volume overload.
- Dextran and polyvinylpyrrolidone interfere with blood grouping and cross-matching.

SHOCK

Shock occurs when there is a severe decrease in tissue perfusion. The important manifestations of shock are hypotension, tachycardia, thready pulse, pale, cold and clammy skin, hypoventilation, oliguria, clouding of consciousness, etc.

■ Types and Causes of Shock

Different types of shock and their causes are listed in Table 4.7.

Table 4.7 Types and Causes of Shock

Type	Causes
Hypovolaemic shock	Haemorrhage, burns, severe vomiting and diarrhoea, diabetic ketoacidosis, etc.
Cardiogenic shock	Acute myocardial infarction, arrhythmias, etc.
Septic shock	Serious bacterial infections; most commonly gram-negative infections
Neurogenic shock	Traumatic spinal cord injury, spinal anaesthetics, etc.
Anaphylactic shock	Drugs (penicillins, lignocaine, etc.), bee sting, shell fish, etc.

In hypovolaemic shock, there is a decrease in circulating blood volume. Cardiogenic shock is due to pump failure. In septic, anaphylactic and neurogenic shock, there is a decrease in systemic vascular resistance leading to low output and tissue underperfusion.

■ Management of Shock

General measures

1. Maintain airway and breathing. Oxygen inhalation—if necessary, artificial ventilation.
2. Establish i.v. line, maintain fluid and electrolyte balance.
3. Collect blood sample for blood count, culture, electrolytes, glucose, blood gas analysis, grouping and cross-matching.
4. Monitor heart rate, BP, urine output, level of consciousness, respiration, central venous pressure, etc.
5. Intravenous sodium bicarbonate to correct acidosis, if any.
Further treatment depends on the type of shock.

■ Hypovolaemic Shock

Achieve haemostasis in case of haemorrhagic shock. Intravenous fluids to restore the loss, e.g. dextrose, normal saline, Ringer lactate, dextran, etc. Blood transfusion in case of acute haemorrhage.

■ Septic Shock

- Intravenous fluids with careful monitoring.
- *Antibiotics*: Empirical therapy should be started early to treat infection.
- Activated protein C is administered by i.v. infusion. It has antithrombotic, fibrinolytic and anti-inflammatory properties. It is given to patients with severe sepsis and organ failure.
- *Glucocorticoids*: Their role is controversial. Intravenous hydrocortisone may be helpful in patients with septic shock in adrenal insufficiency.
- Vasopressors like phenylephrine, noradrenaline, etc. are used. They are administered as i.v. infusion.

■ Anaphylactic Shock

See pp. 37, 82.

■ Cardiogenic Shock

- Aspirin
- Reperfusion by PCI/coronary artery bypass/thrombolytics.
- Vasopressors like dopamine, dobutamine and noradrenaline can be used as i.v. infusion.
- Intravenous heparin
- Treat arrhythmias with drugs or pacing.
- Pain and anxiety are relieved by i.v. morphine.

■ Neurogenic Shock

- Establish airway
- Oxygen to be administered
- Fluid resuscitation, blood transfusion, use of vasopressors
- Immobility of neck and body (if there is spinal injury)

This page intentionally left blank

Kidney is mainly a regulatory organ; it also has excretory function. The functional unit of kidney is nephron. Each kidney contains about 1 million nephrons. The functions of kidney are:

1. **Regulatory:** Acid–base, fluid and electrolyte balance.
2. **Excretory:** Excretion of nitrogenous waste products.
3. **Hormonal:** Activation of vitamin D, production of renin and erythropoietin.

■ Mechanism of Urine Formation

It consists of the following steps:

1. Glomerular filtration
2. Tubular reabsorption
3. Active tubular secretion

Urine formation begins with glomerular filtration. The volume of fluid filtered is about 180 L/day, of which more than 99% gets reabsorbed in the renal tubules; urine output is about 1–1.5 L/day. After filtration, fluid traverses in the renal tubules. The tubular fluid contains Na^+ , K^+ , Cl^- , HCO_3^- , amino acids, glucose, etc.

Proximal convoluted tubule: Site 1 (Fig. 5.1)

Most of the filtered Na^+ is actively reabsorbed; chloride is reabsorbed passively along with sodium. Carbonic anhydrase plays an important role in Na^+ – H^+ exchange (Na^+ – H^+ antiporter) and helps in the reabsorption of HCO_3^- . Potassium, glucose, amino acids, etc. are also reabsorbed in the proximal convoluted tubule (PCT). Proportionately, water also gets reabsorbed—so the tubular fluid in the PCT remains isotonic.

Loop of Henle

The descending limb is impermeable to Na^+ and urea, and highly permeable to water. Hence, fluid in the loop becomes hypertonic.

Thick ascending limb of loop of Henle: Site 2 (Fig. 5.1)

The thick ascending limb is impermeable to water but highly permeable to Na^+ and Cl^- . Active reabsorption of sodium and chloride occurs by Na^+ – K^+ – 2Cl^- cotransporter. This is selectively blocked by loop diuretics. Ca^{2+} and Mg^{2+} are also reabsorbed at this site.

Early distal tubule: Site 3 (Fig. 5.1)

It is impermeable to water, but sodium and chloride are reabsorbed with the help of Na^+ – Cl^- symporter. This is blocked by thiazides.

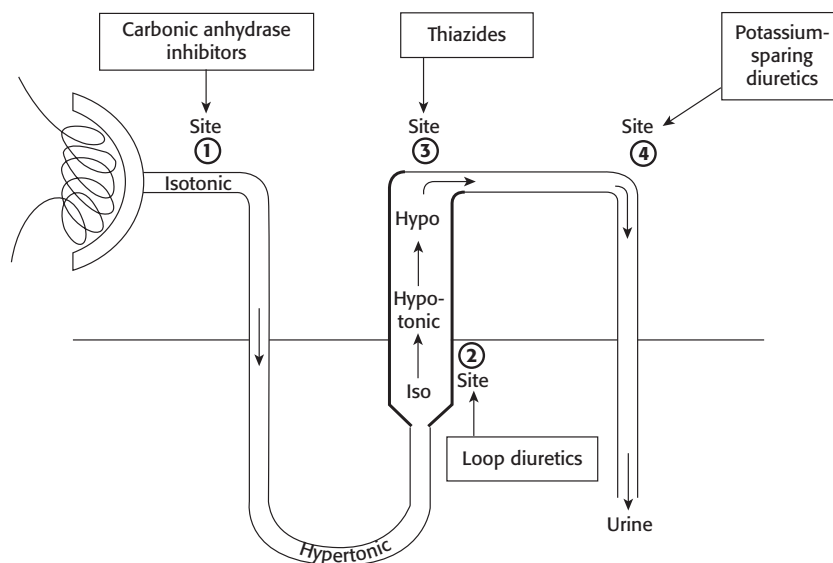

Fig. 5.1 Nephron showing various sites of action of diuretics.

Late distal convoluted tubule and collecting duct: Site 4 (Fig. 5.1)

Sodium is actively reabsorbed; chloride and water diffuse passively. Exchange of Na^+/K^+ , H^+ ions occur. The Na^+-K^+ exchange is under the influence of aldosterone (aldosterone promotes Na^+ absorption and K^+ excretion). Absorption of fluid in the collecting duct (CD) is under the influence of antidiuretic hormone (ADH). In the absence of ADH, the CD becomes impermeable to water and a large amount of dilute urine is excreted. Normally, H^+ ions present in urine convert NH_3 to NH_4^+ , which is excreted.

DIURETICS

Diuretics are drugs that promote the excretion of Na^+ and water in urine.

Classification according to primary site of action in the nephron (Fig. 5.1)

- Drugs acting at proximal convoluted tubule (PCT) (Site 1)**
 - Carbonic anhydrase inhibitor:* Acetazolamide.
- Drugs acting at thick ascending limb of loop of Henle (Site 2)**
 - Loop diuretics:* Furosemide, bumetanide, torsemide.
- Drugs acting at early distal tubule (Site 3)**
 - Thiazides:* Chlorothiazide, hydrochlorothiazide, benzthiazide, polythiazide.
 - Thiazide like diuretics:* Chlorthalidone, indapamide, metolazone.
- Drugs acting at late distal tubule and collecting duct (CD) (Site 4)**
 - Aldosterone antagonist:* Spironolactone.
 - Direct inhibitors of Na^+ channels:* Amiloride, triamterene.
- Drugs acting on entire nephron (main site of action is loop of Henle)**
 - Osmotic diuretics:* Mannitol, glycerol, isosorbide.

Carbonic Anhydrase Inhibitors

Mechanism of action (Fig. 5.2)

Both CO_2 and H_2O diffuse into the tubular cell where H_2CO_3 is formed under the influence of carbonic anhydrase. Carbonic acid (H_2CO_3) dissociates into H^+ and HCO_3^- . The H^+ ions exchange with luminal Na^+ (Na^+-H^+ antiporter). In the lumen, H^+ ions combine with HCO_3^- and form H_2CO_3 . The H_2CO_3 dissociates into CO_2 and H_2O with the help of carbonic anhydrase, which is present near the brush border (Fig. 5.2). The main site of action of acetazolamide is proximal tubule (site 1); it also acts in the collecting duct. Acetazolamide, by inhibiting carbonic anhydrase enzyme, prevents the formation of H^+ ions. Thus, Na^+-H^+ exchange is prevented. Na^+ is excreted along with HCO_3^- in urine.

In the distal convoluted tubule (DCT), increased Na^+-K^+ exchange leads to loss of K^+ . The net effect is loss of Na^+ , K^+ and HCO_3^- in urine, resulting in alkaline urine.

Uses

Acetazolamide is not used as diuretic because of its low efficacy. It is used in the following:

1. **Glaucoma:** Carbonic anhydrase inhibitors decrease intraocular pressure (IOP) by reducing the formation of aqueous humour. Acetazolamide is used in acute congestive glaucoma by oral and i.v. routes. Topical carbonic anhydrase inhibitors are used in chronic simple glaucoma (see p. 59).
2. To alkalinize urine in acidic drug poisoning.
3. **Acute mountain sickness:** Acetazolamide can be used both for symptomatic relief and prophylaxis of acute mountain sickness.
4. **Miscellaneous:** As an adjuvant in epilepsy; treatment of metabolic alkalosis resulting from use of diuretics in congestive heart failure.

Adverse effects

These include hypersensitivity reactions (skin rashes, fever, nephritis, etc.), headache, drowsiness, paraesthesia, hypokalaemia, metabolic acidosis and renal stones.

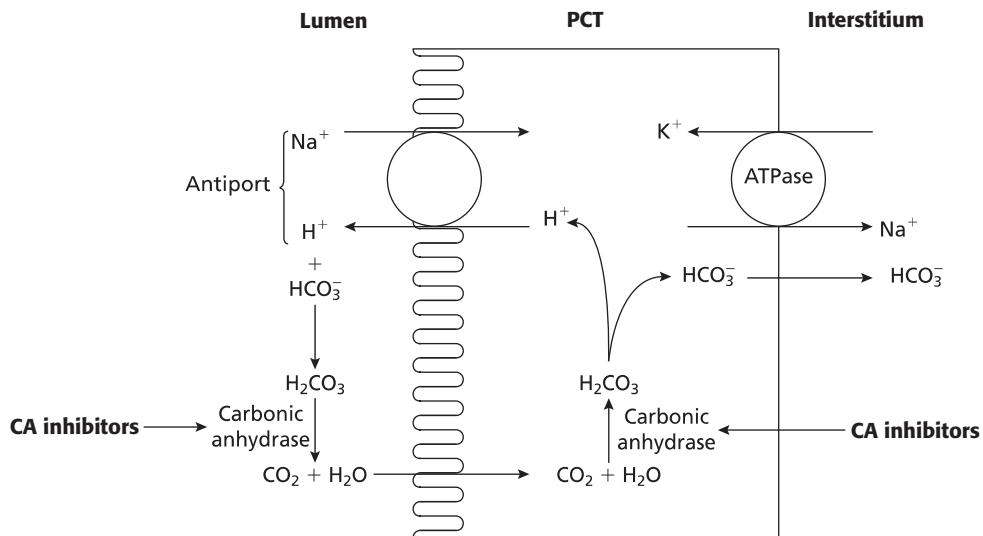

Fig. 5.2 Mechanism of action of carbonic anhydrase (CA) inhibitors.

Contraindications

1. **Liver disease:** Hepatic coma may be precipitated in patients with cirrhosis due to decreased excretion of ammonia (NH_3) in alkaline urine.
2. **Chronic obstructive pulmonary disease (COPD):** Worsening of metabolic acidosis is seen in patients with chronic obstructive pulmonary disease.

Osmotic Diuretics

These include mannitol, glycerol and isosorbide.

Mannitol: Mannitol is administered intravenously. It is neither metabolized in the body nor reabsorbed from the renal tubules. It is pharmacologically inert and is freely filtered at the glomerulus.

Glycerol: Glycerol can be used orally to reduce IOP in acute congestive glaucoma.

Mechanism of action

Osmotic diuretics draw water from tissues by osmotic action. This results in increased excretion of water and electrolytes. Their main site of action is the loop of Henle and proximal tubule.

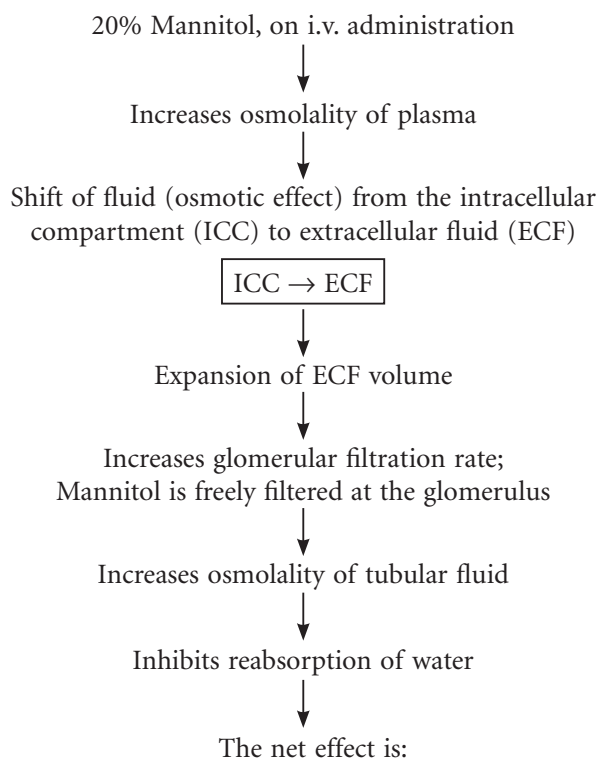

- Increase in urine volume
- Increased urinary excretion of Na^+ , K^+ , Ca^{2+} , Mg^{2+} , Cl^- , HCO_3^- and PO_4^{3-}

Uses of osmotic diuretics

1. Mannitol is used to prevent acute renal shutdown in shock, cardiovascular surgery, haemolytic transfusion reactions, etc.

2. Mannitol is used to reduce elevated intracranial tension (ICT) following head injury or tumour. It draws fluid from the brain into the circulation by osmotic effect, thus lowering ICT.
3. Mannitol 20% (i.v.), glycerol 50% (oral) and isosorbide (oral) are used to reduce elevated IOP in acute congestive glaucoma. They draw fluid from eye, by osmotic effect, into blood—IOP is decreased.

Adverse effects

1. Too rapid and too much quantity of i.v. mannitol can cause marked expansion of ECF volume, which can lead to pulmonary oedema.
2. Headache, nausea and vomiting may occur.
3. Glycerol can cause hyperglycaemia.

Contraindications

Mannitol is contraindicated in congestive cardiac failure (CCF) and pulmonary oedema because it expands ECF volume by increasing the osmolality of extracellular compartment and increases the load on the heart, thus, aggravating the above condition. Other contraindications are chronic oedema, anuric renal disease and active intracranial bleeding.

Loop Diuretics (High-Ceiling Diuretics)

Loop diuretics are called *high-ceiling diuretics* because they are highly efficacious—have maximal Na^+ excreting capacity when compared to thiazides and potassium-sparing diuretics.

Mechanism of action (Fig. 5.3)

The site of action of loop diuretics is the thick ascending limb of loop of Henle (site 2).

Loop diuretics bind to luminal side of $\text{Na}^+-\text{K}^+-2\text{Cl}^-$ cotransporter and block its function. There is an increased excretion of Na^+ and Cl^- in urine. The tubular fluid reaching the DCT contains large amount of Na^+ . Hence, more Na^+ exchanges with K^+ leading to K^+ loss. Furosemide has weak carbonic anhydrase inhibiting activity, hence increases the excretion of HCO_3^- and PO_4^{3-} . Loop diuretics also increase the excretion of Ca^{2+} and Mg^{2+} .

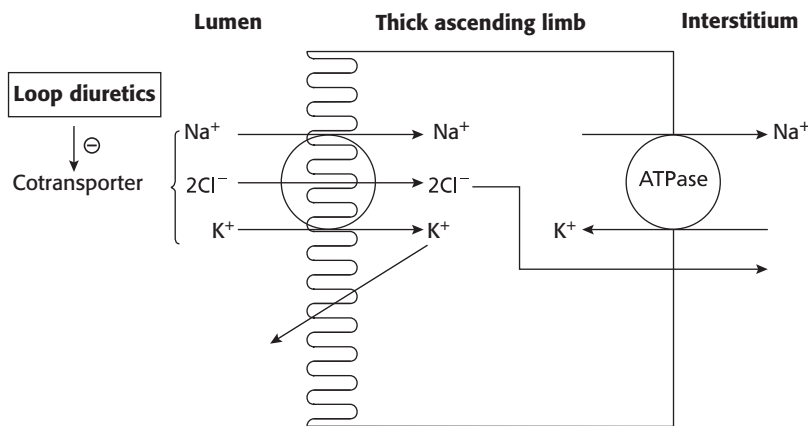
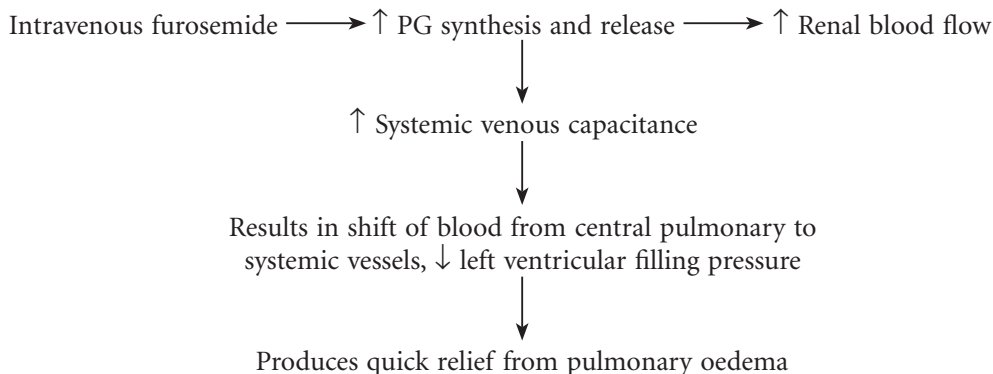

Fig. 5.3 $\text{Na}^+-\text{K}^+-2\text{Cl}^-$ cotransport system in thick ascending limb and the mechanism of action of loop diuretics.

Loop diuretics are rapidly absorbed through the gastrointestinal tract. Furosemide and bumetanide are administered by oral, i.v., and i.m. routes. Torsemide is given orally. Furosemide has a rapid onset of action—within 2–5 min of i.v., 10–20 min after i.m. and 30–40 min after oral administration. The duration of action of furosemide is short (2–4 hours).

Therapeutic uses

1. During the initial stages of renal, hepatic and cardiac oedema, loop diuretics are preferred.
2. Intravenous furosemide is used in hypercalcaemia as it promotes excretion of Ca^{2+} in urine.
3. Acute pulmonary oedema—loop diuretics act in the following way:



4. Loop diuretics may be used in cerebral oedema but i.v. mannitol is the preferred drug.
5. Hypertension: Loop diuretics can be used in hypertension associated with CCF/renal failure and in hypertensive emergencies. Furosemide is not preferred in uncomplicated primary hypertension because of its short duration of action.
6. Loop diuretics can be used in mild hyperkalaemia.

Adverse effects

1. **Electrolyte disturbances** are the common adverse effects seen with loop diuretics. They are:
 - a. **Hypokalaemia:** It is the most important adverse effect. It can cause fatigue, muscular weakness and cardiac arrhythmias, especially in patients taking digitalis. Hypokalaemia can be prevented by using a combination of loop diuretic with potassium-sparing diuretic. It can be treated by K^+ supplementation.
 - b. **Hyponatraemia:** Loop diuretics can cause depletion of sodium from the body.
 - c. **Hypokalaemic metabolic alkalosis:** As less K^+ is available (due to hypokalaemia) for exchange with Na^+ in the DCT, more Na^+/H^+ exchange takes place leading to H^+ loss, thus, causing hypokalaemic alkalosis.
 - d. **Hypocalcaemia and hypomagnesaemia:** These are due to the increased urinary excretion of Ca^{2+} and Mg^{2+} , respectively.
2. The **metabolic disturbances** include:
 - a. **Hyperglycaemia:** This can occur due to decreased insulin secretion.
 - b. **Hyperuricaemia:** These drugs decrease renal excretion of uric acid and may precipitate attacks of gout.
 - c. **Hyperlipidaemia:** They increase plasma triglycerides and LDL cholesterol levels.

3. **Ototoxicity** manifests as deafness, vertigo and tinnitus. Symptoms are usually reversible on stoppage of therapy. The risk of ototoxicity is increased in patients with renal impairment and in those receiving other ototoxic drugs like cyclosporine, aminoglycosides, etc.
4. **Hypersensitivity:** Skin rashes, eosinophilia, photosensitivity, etc. may occur.

Drug interactions

1. Furosemide/thiazides \times digoxin: These diuretics cause hypokalaemia, which increases the binding of digoxin to $\text{Na}^+\text{K}^+\text{-ATPase}$ leading to digoxin toxicity.
2. Furosemide \times aminoglycosides: Both are ototoxic drugs and cause enhanced toxicity when used together.
3. Furosemide \times nonsteroidal antiinflammatory drugs: Nonsteroidal antiinflammatory drugs (NSAIDs) inhibit prostaglandin (PG) synthesis and block prostaglandin-mediated haemodynamic changes of loop diuretics. Chronic use of NSAIDs leads to Na^+ and H_2O retention and diminish the antihypertensive effect of loop diuretics/ thiazides.
4. Furosemide/chlorthalidone \times amiloride: Furosemide/chlorthalidone causes hypokalaemia, whereas amiloride conserves potassium. The combination of these diuretics does not alter plasma potassium levels and also improve diuretic response—synergistic effect.

Thiazides (Benzothiadiazides) and Thiazide-like Diuretics

Thiazides are medium-efficacy diuretics.

Mechanism of action (Fig. 5.4)

Thiazides inhibit $\text{Na}^+\text{-Cl}^-$ symport in early distal tubule (site 3) and increase Na^+ and Cl^- excretion. There is increased delivery of Na^+ to the late distal tubule. Hence, there is increased exchange of $\text{Na}^+\text{-K}^+$, which results in K^+ loss. Some of the thiazides also have weak carbonic anhydrase inhibitory action and increase HCO_3^- loss. Therefore, there is a net loss of Na^+ , K^+ , Cl^- , HCO_3^- in urine. Unlike loop diuretics, thiazides decrease Ca^{2+} excretion.

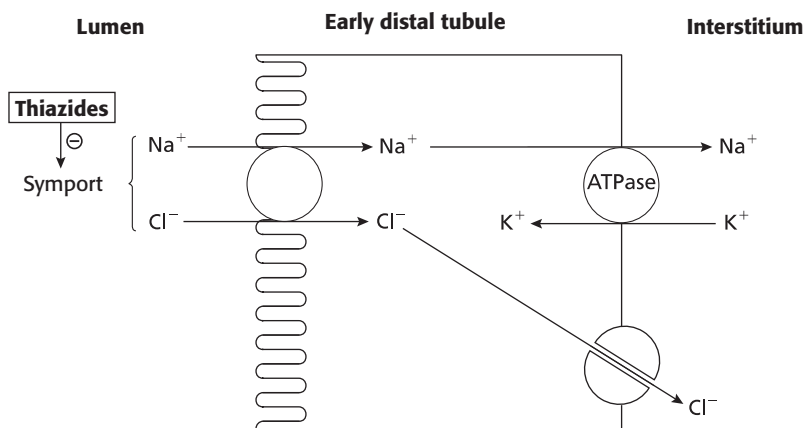

Fig. 5.4 NaCl reabsorption in DCT and mechanism of action of thiazides.

Pharmacokinetics

Thiazides are administered orally. They have a long duration of action and are excreted in urine.

Uses

1. **Hypertension:** Thiazides are used in the treatment of essential hypertension (see p. 102).
2. **Heart failure:** Thiazides are used for mild-to-moderate cases of heart failure (see p. 119).
3. **Hypercalciuria:** Thiazides are used in calcium nephrolithiasis as they reduce the urinary excretion of calcium.
4. **Diabetes insipidus** (see p. 139).

Adverse effects

1. Thiazides cause electrolyte disturbances, which include hypokalaemia, hyponatraemia, metabolic alkalosis, hypomagnesaemia and hypercalcaemia.
 - a. Hypokalaemia is more common with thiazides because of its long duration of action.
 - b. Hypercalcaemia is due to decreased urinary excretion of calcium.
2. The metabolic disturbances are similar to that of loop diuretics—hyperglycaemia, hyperlipidaemia and hyperuricaemia.
3. They may cause impotence; hence thiazides are not the preferred antihypertensives in young males.
4. Others: Skin rashes, photosensitivity, gastrointestinal disturbances like nausea, vomiting, diarrhoea, etc. can occur.

Thiazide-like Diuretics

Chlorthalidone is a frequently used thiazide-like diuretic in hypertension as it has a long duration of action. Indapamide and metolazone are more potent, longer acting and produce fewer adverse effects than thiazides. They are used in hypertension.

Potassium-sparing Diuretics

Spironolactone (Aldosterone Antagonist)

Spironolactone is an aldosterone antagonist. It is a synthetic steroid and structurally related to aldosterone.

Aldosterone enters the cell and binds to specific mineralocorticoid receptor (MR) in the cytoplasm of late distal tubule and collecting duct (CD) cells (site 4). The hormone–receptor complex (MR–AL) enters the cell nucleus, where it induces the synthesis of aldosterone-induced proteins (AIPs). The net effect of AIPs is to retain sodium and excrete potassium (Fig. 5.5).

Spironolactone competitively blocks the mineralocorticoid receptor and prevents the formation of AIPs. Therefore, spironolactone promotes Na⁺ excretion and K⁺ retention. Spironolactone is most effective when circulating aldosterone levels are high. It also increases Ca²⁺ excretion.

Pharmacokinetics

Spironolactone is administered orally, gets partly absorbed and is highly bound to plasma proteins; extensively metabolized in liver and forms active metabolite, canrenone, which has long plasma half-life.

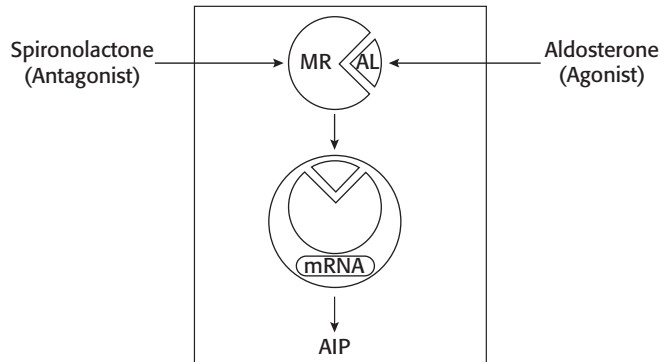

Fig. 5.5 Mechanism of action of spironolactone. MR, mineralocorticoid receptor; AL, aldosterone; AIP, aldosterone-induced protein.

Uses

1. In oedematous conditions associated with secondary hyperaldosteronism (congestive cardiac failure, hepatic cirrhosis and nephrotic syndrome).
2. Spironolactone is often used with thiazides/loop diuretics to compensate K^+ loss.
3. Resistant hypertension due to primary hyperaldosteronism (Conn's syndrome)

Adverse effects

Hyperkalaemia is the major adverse effect of aldosterone antagonists. The risk is greater in patients with renal disease or in those receiving ACE inhibitors, ARBs, β -blockers, NSAIDs, etc.

Other adverse effects include nausea, vomiting, diarrhoea, peptic ulcer, drowsiness, mental confusion, menstrual disturbances, gynaecomastia, decreased libido and impotence.

Drug interaction

ACE inhibitors \times spironolactone: Dangerous hyperkalaemia can occur.

Amiloride and Triamterene (Directly Acting Drugs)

Both are directly acting potassium-sparing diuretics. They directly block the Na^+ channels in the luminal membrane of the cells of the late DCT and CD. The net effect of these drugs is to increase Na^+ excretion and retain potassium; hence these are called K^+ -sparing diuretics. They are administered orally. Both are low-efficacy diuretics. Triamterene is extensively metabolized and excreted in urine, whereas amiloride is excreted unchanged in urine.

Uses

Potassium-sparing diuretics are used with thiazides/loop diuretics for the treatment of hypertension. The combination therapy increases the diuretic and antihypertensive effects of thiazides or loop diuretics. They also correct hypokalaemia due to thiazides/loop diuretics.

Adverse effects

These include hyperkalaemia, nausea, vomiting, diarrhoea, headache, dizziness, muscle cramps, etc.

Various diuretics with their site and mechanism of action are shown in Table 5.1.

Table 5.1 Diuretics with Their Site and Mechanism of Action

Diuretics	Site of Action	Mechanism of Action	Diuretic Efficacy
Acetazolamide	Site 1 (PCT)	Carbonic anhydrase inhibitor	Low
Loop diuretics	Site 2 (thick ascending limb of loop of Henle)	Inhibit $\text{Na}^+ - \text{K}^+ - 2\text{Cl}^-$ cotransport	High
Thiazides	Site 3 (early distal tubule)	Inhibit $\text{Na}^+ - \text{Cl}^-$ symport	Medium
Potassium-sparing diuretics	Site 4 (DT and CD)	Aldosterone antagonist (spironolactone) Directly acting (amiloride and triamterene)	Low
Mannitol	Loop of Henle and PCT	Osmotic effect	High

ANTIDIURETICS

Vasopressin

Vasopressin [arginine vasopressin (AVP); antidiuretic hormone (ADH)] is a peptide hormone synthesized in the supraoptic and paraventricular nuclei of the hypothalamus and stored in posterior pituitary.

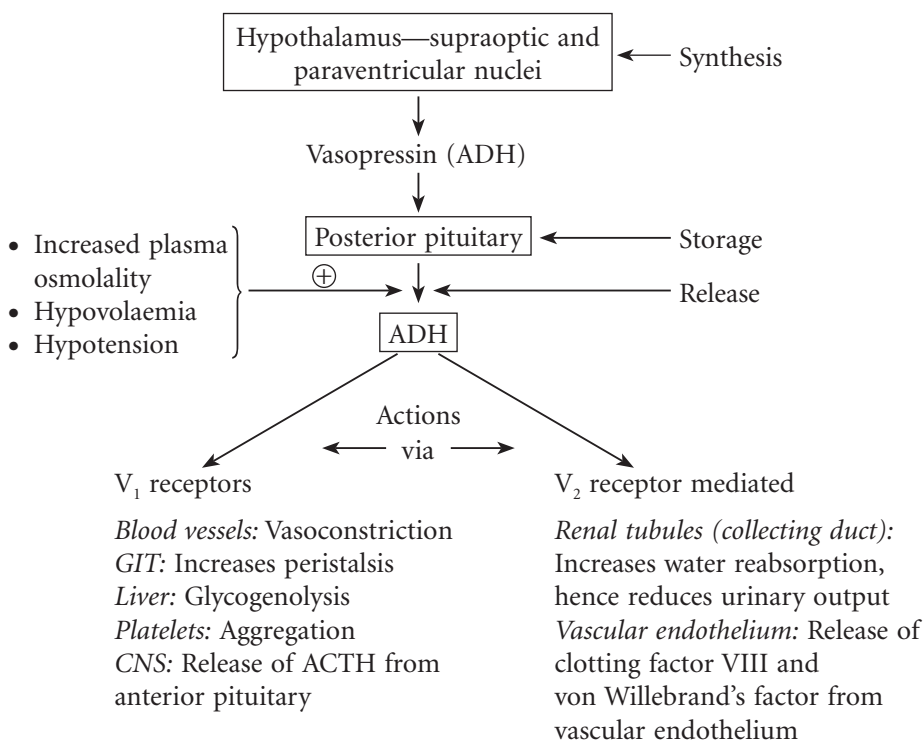

Uterus: Contraction of the smooth muscle by vasopressin is mediated through oxytocin receptors.

Synthetic arginine vasopressin (AVP) is a peptide hormone, hence, is not effective orally. It is administered by i.v., i.m., s.c. or intranasal routes and has a short duration of action.

Vasopressin Analogues

Desmopressin: It is a selective V_2 -receptor agonist and is more potent than vasopressin as an antidiuretic. It has negligible vasoconstrictor action. It is administered by oral, nasal and parenteral routes.

Lypressin: It acts on both V_1 - and V_2 -receptors. It is less potent but longer acting than vasopressin. It is administered parenterally.

Terlipressin: It is a prodrug of vasopressin with selective V_1 action. It is administered intravenously.

Felypressin: It is a synthetic analogue of vasopressin. It is mainly used for its vasoconstrictor (V_1) action along with local anaesthetics to prolong the duration of action. Felypressin should be avoided in pregnancy because of its oxytocic (uterine stimulant) activity.

Uses of vasopressin analogues

1. Due to V_1 -receptor mediated actions

For emergency control of bleeding oesophageal varices: ADH controls bleeding by constricting mesenteric blood vessels.

2. Due to V_2 -receptor-mediated actions

a. **Neurogenic diabetes insipidus (DI):** Desmopressin is the drug of choice.

Diabetes insipidus (DI) is a condition characterized by excretion of large volume of dilute urine either due to decreased secretion of ADH from the neurohypophysis (neurogenic DI) or due to an inadequate renal tubular response to ADH (nephrogenic DI).

- Thiazides are useful for both central and nephrogenic DI.
- Amiloride is used for the treatment of lithium-induced nephrogenic DI.
- Indomethacin reduces urine volume in nephrogenic DI by inhibiting renal prostaglandin synthesis.

b. **Haemophilia and von Willebrand's disease:** Desmopressin, administered intravenously, controls bleeding by increasing factor VIII and von Willebrand's factor.

c. **Primary nocturnal enuresis:** Administration of desmopressin at bedtime reduces nocturnal urine volume.

Adverse effects

1. Nausea, vomiting, diarrhoea, belching and abdominal cramps.
2. Backache is due to uterine contraction.
3. Intranasal administration may cause local irritation and ulceration.
4. Fluid retention and hyponatraemia can occur.

Key Points for Dentists

- Regularly monitor the weight of patients on diuretics.
- Administer diuretics usually in the morning.
- Monitor diet and educate patient about food rich in potassium (banana, fruit juice, tender coconut water, etc.).
- Monitor for possible drug interactions if patient is also on ACE inhibitors, lithium, digoxin, etc.
- Administer syrup of potassium chloride diluted in a tumbler full of water to avoid intestinal ulceration.
- Slowly administer i.v. potassium chloride, as it has a cardiac-depressant effect.
- Monitor serum electrolytes, BP and pulse when the patient is on diuretics.

This page intentionally left blank

Drugs Acting on Central Nervous System

6

NEUROTRANSMITTERS AND CENTRAL NERVOUS SYSTEM

Neurotransmitters in CNS (Fig. 6.1)

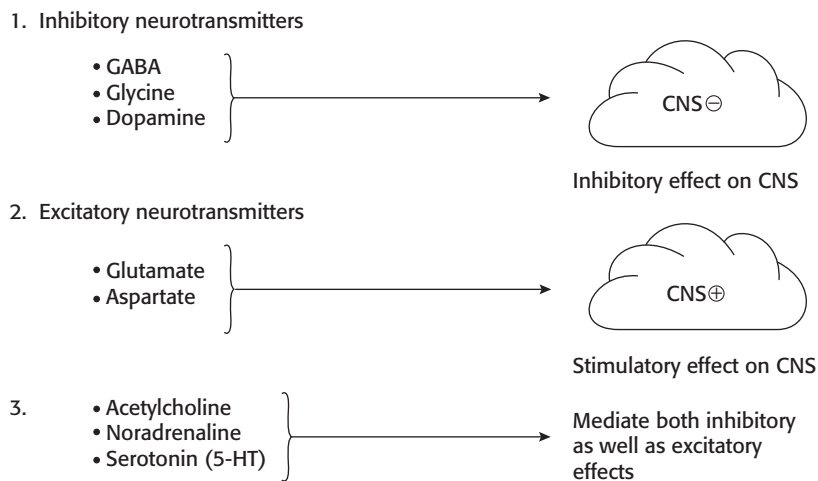

Fig. 6.1 Neurotransmitters in CNS: GABA, γ -aminobutyric acid; 5-HT, 5-hydroxytryptamine; \ominus : inhibition; \oplus : stimulation.

Inhibitory postsynaptic potential (IPSP)

When an inhibitory transmitter binds and interacts with specific receptors on postjunctional membrane, the membrane permeability to K^+ or Cl^- increases (Fig. 6.2).

Excitatory postsynaptic potential (EPSP)

When an excitatory neurotransmitter binds and interacts with the specific receptors on the postjunctional membrane, the membrane permeability to cations increases (Fig. 6.3).

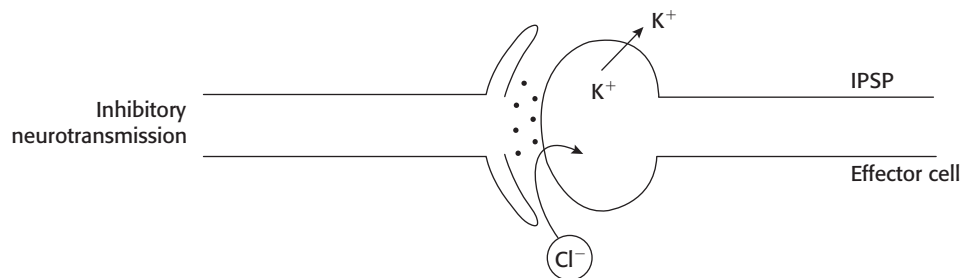

Fig. 6.2 K^+ ions move out and Cl^- ions move in resulting in hyperpolarization (IPSP).

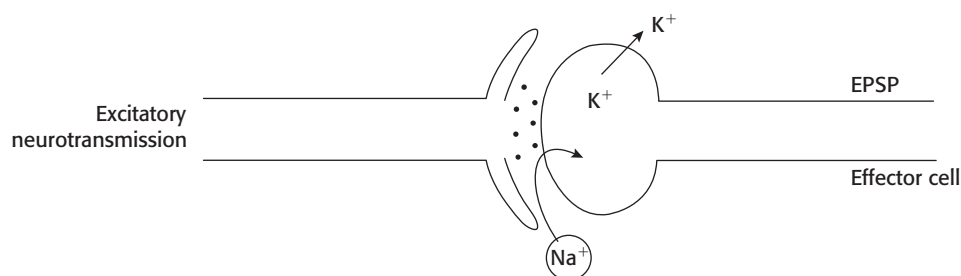

Fig. 6.3 Na^+ ions move in (Na^+ influx) resulting in depolarization followed by K^+ efflux.

Manifestations of CNS depression and stimulation

CNS depression	CNS stimulation
Drowsiness	Excitement
Sedation	Euphoria
Hypnosis	Insomnia
Disorientation	Tremors
Confusion	Twitching
Unconsciousness	Convulsions
Coma	Coma
Death	Death

SEDATIVES AND HYPNOTICS

Sedative is a drug that reduces excitement and calms the person. Hypnotic is a drug that produces sleep resembling normal sleep.

Sleep: The phases of sleep include non-rapid eye movement (NREM) sleep and rapid eye movement (REM) sleep. NREM sleep is divided into stage 0, 1, 2, 3, and 4. Normally, about 50% of sleep time is spent in stage 2. Slow-wave sleep includes stage 3 and 4. REM sleep constitutes about 30% of the sleep time and lasts for 5–30 min in each cycle of sleep.

Types of sleep disorders and their treatment are depicted in Table 6.1.

Table 6.1 Types of Sleep Disorders and Their Treatment

Sleep Disorder	Treatment
Lack of sleep (insomnia) <ul style="list-style-type: none"> • Transient insomnia (<3 days) • Short-term insomnia (3 days to 3 weeks) • Long-term insomnia (>3 weeks) 	Sedatives and hypnotics
Hypersomnia (narcolepsy)	Amphetamine
Nocturnal enuresis (bed wetting)	Tricyclic antidepressants

Classification of sedatives and hypnotics

- Benzodiazepines:** Diazepam, oxazepam, lorazepam, flurazepam, nitrazepam, temazepam, clonazepam, clobazam, chlordiazepoxide, triazolam, midazolam, alprazolam (Table 6.2).
- Barbiturates:**
 - Long acting:* Phenobarbitone, mephobarbitone.
 - Short acting:* Pentobarbitone, secobarbitone.
 - Ultra-short acting:* Thiopentone, methohexitone.
- Non-benzodiazepine hypnotics:** Zolpidem, zopiclone, zaleplon, eszopiclone.
- Miscellaneous:** Chloral hydrate, promethazine, neuroleptics, opioids, etc.

BENZODIAZEPINES

All benzodiazepines (BZDs) have a benzene ring fused to a seven-membered diazepine ring.

Sites of action

BZDs act at midbrain, limbic system, ascending reticular activating system (ARAS), brain stem, cerebellum, etc.

Mechanism of action

Benzodiazepines facilitate action of gamma-aminobutyric acid (GABA)—**they potentiate inhibitory effects of GABA.**

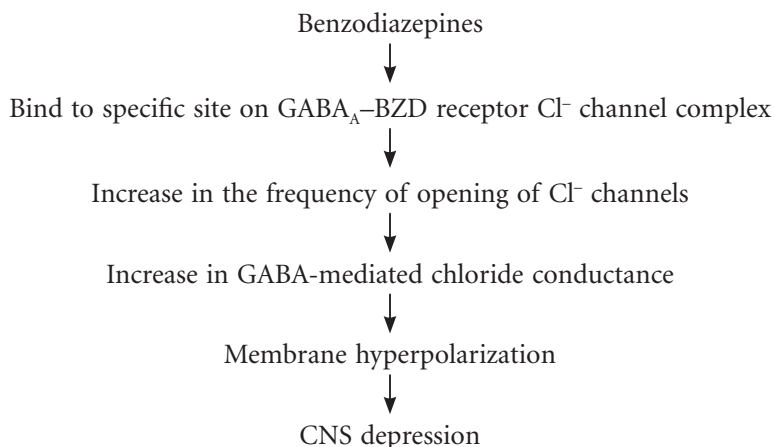

Benzodiazepines have no GABA-mimetic action.

Pharmacological actions and therapeutic uses

1. **Sedation and hypnosis:** Benzodiazepines decrease time required to fall asleep (sleep latency). The total sleep time is increased. They shorten all stages of NREM sleep except stage 2, which is prolonged. The duration of REM sleep is usually decreased. BZDs reduce night awakenings and produce refreshing sleep.

At present, BZDs are the preferred drugs for treatment of short-term insomnia because:

- They have a wide therapeutic index.
- They cause near-normal sleep; less rebound phenomena on withdrawal.
- They produce minimal hangover effects (headache and residual drowsiness on waking).
- They cause minimal respiratory depression.
- They are less likely to cause tolerance and dependence when used for short period.
- They have no enzyme-inducing property; hence drug interactions are less.
- They have a specific BZD receptor antagonist, flumazenil, for the treatment of overdose.

Long-term use of BZDs for insomnia is not recommended because of tolerance, dependence and hangover effects; but for occasional use by air travellers, shift workers, etc. these drugs are ideal.

2. **Anticonvulsant:** Diazepam, lorazepam, clonazepam, clobazam, etc. have selective anticonvulsant effect. Intravenous (i.v.) diazepam/lorazepam is used to control life-threatening seizures in status epilepticus, tetanus, drug-induced convulsions, febrile convulsions, etc. Clonazepam is used in the treatment of absence seizures.
3. **Diagnostic (endoscopies) and minor operative procedures:** Intravenous BZDs are used because of their sedative–amnesic–analgesic and muscle-relaxant properties.
4. **Preanaesthetic medication:** These drugs are used as preanaesthetic medication because of their sedative–amnesic and anxiolytic effects. Hence, the patient cannot recall the perioperative events later.
BZDs do not cause true general anaesthesia (GA). Intravenous diazepam, lorazepam, midazolam, etc. are combined with other central nervous system (CNS) depressants to produce GA.
5. **Antianxiety (anxiolytic) effect:** Some of the BZDs (diazepam, oxazepam, alprazolam, lorazepam, chlordiazepoxide, etc.) have selective antianxiety action at low doses. The anxiolytic effect is due to their action on limbic system.
6. **Muscle relaxant (centrally acting):** They reduce skeletal muscle tone by inhibiting polysynaptic reflexes in the spinal cord. The relaxant effect of BZDs is useful in spinal injuries, tetanus, cerebral palsy and to reduce spasm due to joint injury or sprain.
7. **To treat alcohol-withdrawal symptoms.**
8. **Conscious sedation:** See p. 156.

The above-mentioned uses can be summarized as follows:

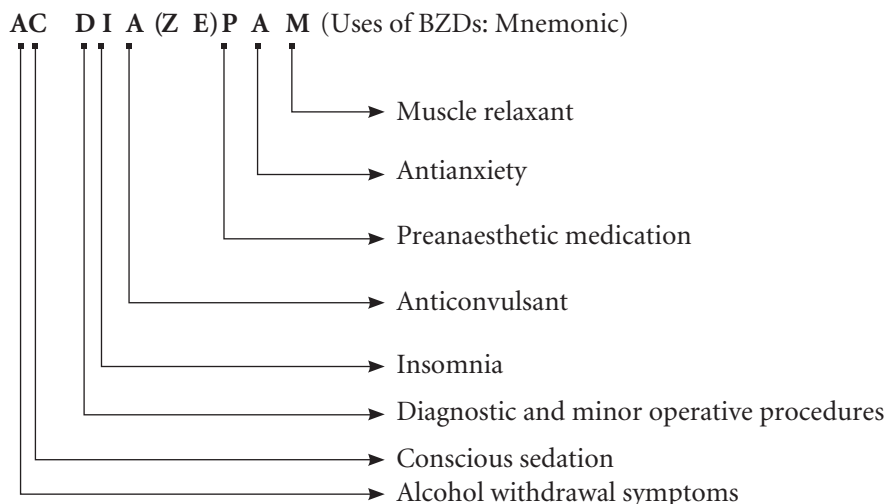

Pharmacokinetics

Benzodiazepines are usually given orally or intravenously and occasionally by rectal route (diazepam) in children. The rate of absorption following oral administration is variable; absorption is erratic from intramuscular (i.m.) site of administration; hence rarely used. They have a large volume of distribution. They have a short duration of action on occasional use because of rapid redistribution, hence are free of residual (hangover) effects, even though elimination half-life is long. Benzodiazepines are metabolized in liver. Some of them produce active metabolites that have long half-life; hence cumulative effects may be seen. The metabolites are excreted in urine. BZDs can cross placental barrier.

Adverse effects

Benzodiazepines have a wide margin of safety. They are generally well tolerated. The common side effects are drowsiness, confusion, blurred vision, amnesia, disorientation, tolerance and drug dependence. Withdrawal after chronic use causes symptoms like tremor, insomnia, restlessness, nervousness and loss of appetite. Use of BZDs during labour may cause respiratory depression and hypotonia in the newborn (Floppy baby syndrome). In some patients, these drugs may produce paradoxical effects, i.e. convulsions and anxiety.

Some of the important features of BZDs have been listed in Table 6.2.

Table 6.2 Important Features of Benzodiazepines

Drug	Formulations with Oral Dose	Important Points
Diazepam (prototype drug)	Oral, i.v., i.m., rectal 5–10 mg	<ul style="list-style-type: none"> • Rapidly absorbed from GI tract • Produces active metabolites • No residual effects on occasional use due to redistribution • It is used to control convulsions but not for long-term therapy of epilepsy because of its sedative effect and rapid development of tolerance to anticonvulsant effect. • It can be used rectally to control convulsions • Other points: See text
Flurazepam	Oral, 15 mg	<ul style="list-style-type: none"> • Has a long duration of action • Useful in insomnia
Nitrazepam	Oral, 5–10 mg	<ul style="list-style-type: none"> • Has a long duration of action • Useful in insomnia • Residual effects are less on occasional use
Oxazepam	Oral, 15 mg	<ul style="list-style-type: none"> • Can be used in patients with liver disease • Mainly used as antianxiety agent
Lorazepam	Oral, i.m., i.v., 0.5–2 mg	<ul style="list-style-type: none"> • Anticonvulsant effect lasts longer than with diazepam because it is less lipid soluble and redistribution is slow • Mainly used as anticonvulsant, antianxiety and preanaesthetic medication
Alprazolam	Oral, 0.5–2 mg	<ul style="list-style-type: none"> • Has antianxiety and antidepressant effects
Temazepam	Oral, 7.5–30 mg	<ul style="list-style-type: none"> • Is short acting • Mainly used for insomnia
Triazolam	Oral 0.125–0.25 mg	<ul style="list-style-type: none"> • Has rapid onset of action; short acting • Mainly used for insomnia —reduces sleep latency
Midazolam	i.v., i.m., 1–2.5 mg (i.v.)	<ul style="list-style-type: none"> • Has rapid onset of action; short acting • Used as preanaesthetic medication, i.v. general anaesthesia with other drug; status epilepticus not responding to other drugs
Chlordiazepoxide	Oral, i.m., i.v. 50–100 mg	<ul style="list-style-type: none"> • Is long acting • Used in alcohol withdrawal and anxiety

■ Inverse Agonists (β -Carboline)

Their interaction with BZD receptors will produce anxiety and convulsions.

■ Benzodiazepine Antagonist (Flumazenil)

Flumazenil competitively reverses the effects of both BZD agonists (CNS depression) and BZD-inverse agonists (CNS stimulation). Flumazenil is not used orally because of its high first-pass metabolism. It is given by i.v. route and has a rapid onset of action. Flumazenil is used in the treatment of BZD overdose and to reverse the sedative effects of BZDs during general anaesthesia. Adverse effects include confusion, dizziness and nausea. It may precipitate withdrawal symptoms (anxiety and convulsions) in dependent subjects (Fig. 6.4).

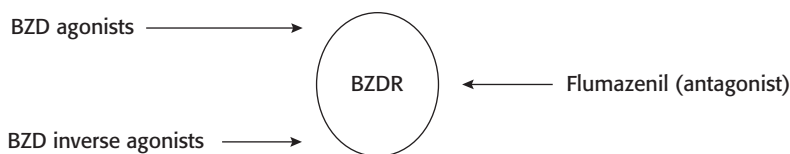

Fig. 6.4 Competitive antagonism. BZDR, benzodiazepine receptor.

BARBITURATES

All barbiturates are derivatives of barbituric acid. They are nonselective CNS depressants and act at many sites, ascending reticular activating system (ARAS) being the main site.

Mechanism of action

Barbiturates have GABA-facilitatory action—they potentiate inhibitory effects of GABA.

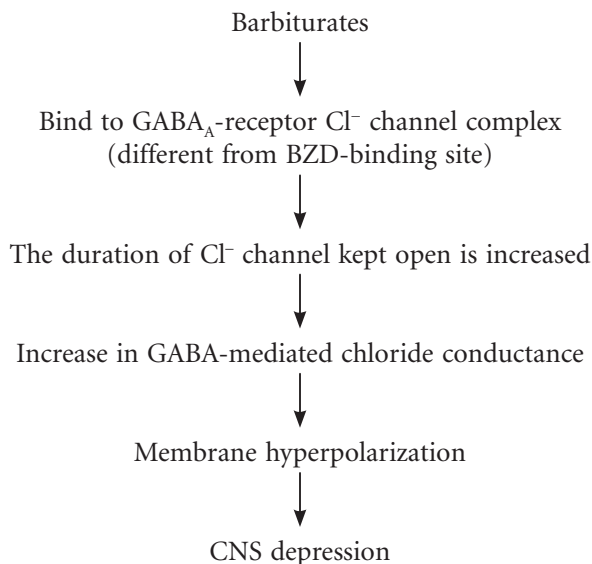

At high concentrations, barbiturates have *GABA-mimetic effect* (i.e. barbiturates can directly increase Cl⁻ conductance into the neuron).

Pharmacological actions and uses

1. **Sedation and hypnosis:** Barbiturates were used in the treatment of insomnia. They decrease sleep latency, duration of REM sleep, stage 3 and 4 of NREM sleep. They cause marked alteration of sleep architecture. At present, barbiturates are not recommended because:
 - They have a low therapeutic index.
 - They cause rebound increase in REM sleep on stoppage of therapy.
 - They cause marked respiratory depression.
 - They produce marked hangover effects (headache and drowsiness on waking).
 - They cause high degree of tolerance and drug dependence.

- They are potent enzyme inducers and cause many drug interactions.
 - They have no specific antidote.
2. **General anaesthesia (GA):** Ultra-short-acting barbiturates (thiopentone and methohexitone) are used for the induction of GA (see p. 151).
 3. **Anticonvulsant:** Phenobarbitone has anticonvulsant effect and is used in the treatment of status epilepticus and generalized tonic–clonic seizures (GTCS).

Adverse effects

1. The common side effects are drowsiness, confusion, headache, ataxia, hypotension and respiratory depression.
2. Hypersensitivity reactions like skin rashes, itching and swelling of face may occur.
3. Tolerance develops to their sedative and hypnotic actions on repeated use.
4. Physical and psychological dependence develops on repeated use.
5. Prolonged use of phenobarbitone may cause megaloblastic anaemia by interfering with absorption of folic acid from the gut.
6. They may precipitate attacks of acute intermittent porphyria; hence barbiturates are contraindicated in porphyria.
7. In case of acute barbiturate poisoning, the signs and symptoms are drowsiness, restlessness, hallucinations, hypotension, respiratory depression, convulsions, coma and death.

Treatment of acute barbiturate poisoning

- Maintain airway, breathing and circulation.
- Maintain electrolyte balance.
- Gastric lavage: After stomach wash, administer activated charcoal that may enhance the elimination of phenobarbitone. Endotracheal intubation is performed before gastric lavage to protect the airway in unconscious patients.
- Alkaline diuresis: There is no specific antidote for barbiturates; main treatment is alkaline diuresis. Intravenous sodium bicarbonate alkalinizes urine. Barbiturates are weakly acidic drugs. In alkaline urine, barbiturates exist in ionized form; so they are not reabsorbed while passing through renal tubules and are rapidly excreted in urine.
- Haemodialysis is employed in severe cases.

Drug interactions

Barbiturates are potent inducers of hepatic microsomal enzymes and reduce the effectiveness of coadministered drugs (e.g. oral contraceptives, oral anticoagulants, oral hypoglycaemics, etc.).

NON-BENZODIAZEPINE HYPNOTICS

Zolpidem: Zolpidem mainly produces hypnotic effect—decreases sleep latency and increases duration of sleep time in insomnia. It produces near-normal sleep like BZDs with minimal alteration in REM sleep; causes minimal hangover effects and rebound insomnia; less likely to produce tolerance and drug dependence; lacks anticonvulsant, antianxiety and muscle-relaxant effects. It is given orally, well absorbed, metabolized in liver and excreted in urine. It has a short duration of action and is used for short-term insomnia. The actions of zolpidem are antagonized by flumazenil. The common side effects are headache, confusion, nausea and vomiting.

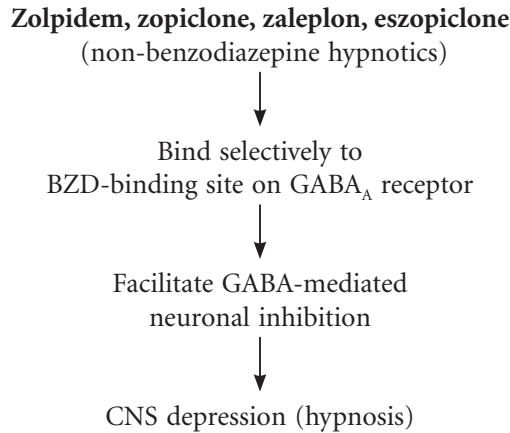
Mechanism of action

Zopiclone: Zopiclone is orally effective and is used for short-term treatment of insomnia. It produces near-normal sleep like BZDs. The side effects are headache, drowsiness, GI disturbances and metallic taste.

Zaleplon: It is useful in sleep-onset insomnia. It is the shortest-acting non-BZD hypnotic.

Eszopiclone: It is used orally for long-term treatment of insomnia.

Key Points for Dentists

- Repeated use of BZDs can cause drug tolerance and dependence.
- Alcohol and tricyclic antidepressants can potentiate the CNS-depressant effect of BZDs, barbiturates, etc.
- Instruct patients to report adverse effects, if any.
- Patients should avoid driving or operating heavy machinery when they are on sedative-hypnotics.

GENERAL ANAESTHETICS

General anaesthesia refers to drug-induced reversible loss of consciousness and all sensations. The features of GA are:

1. Reversible loss of consciousness.
2. Reversible loss of sensation.
3. Analgesia and amnesia.
4. Muscle relaxation and abolition of reflexes.

There is no single anaesthetic agent that can produce all the above effects. Hence, the anaesthetic protocol includes:

1. Premedication.
2. Induction of anaesthesia (e.g. thiopentone and propofol).
3. Maintenance of anaesthesia (N₂O + isoflurane/halothane).
4. Skeletal muscle relaxation.
5. Analgesia—as premedication, during and after the operation.
6. Use of other drugs:
 - To reverse neuromuscular blockade.
 - To reverse the residual effects of opioids (naloxone) and BZDs (flumazenil).

Minimal alveolar concentration (MAC) is the minimum concentration of an anaesthetic in alveoli required to produce immobility in response to a painful stimulus in 50% patients. It indicates the potency of inhalational general anaesthetics.

Mechanism of action of general anaesthetics

The main site of action of anaesthetics is reticular formation, which normally maintains a state of consciousness. Most anaesthetics depress reticular formation by enhancing the activity of inhibitory transmitters and blocking the activity of excitatory transmitters.

Table 6.3 Stages of Anaesthesia

I. Stage of Analgesia	II. Stage of Excitement	III. Stage of Surgical Anaesthesia				IV. Stage of Medullary Paralysis
		Plane 1	Plane 2	Plane 3	Plane 4	
<ul style="list-style-type: none"> The patient is conscious but drowsy 	<ul style="list-style-type: none"> Patient loses consciousness Sympathetic activity is increased; ↑Heart rate (HR), ↑blood pressure (BP), pupils are dilated; muscle tone is increased; breathing is irregular 	<ul style="list-style-type: none"> Respiration becomes regular Muscles relax Reflexes are gradually lost Intercostal muscles are paralysed 			<ul style="list-style-type: none"> Respiration and vasomotor centre are depressed; death occurs within a few minutes 	

Stage II is the most dangerous period. All these stages (Table 6.3) are seen mainly with ether because of slow action. Surgical procedures are performed in stage III. The aim of induction is to reach stage III as early as possible followed by maintenance anaesthesia and muscle relaxation.

Indications for general anaesthesia in dentistry

In dental practice, need for general anaesthesia is determined on an individual basis. It is indicated in:

- **Acute dentoalveolar abscess and severe pulpitis:** It may be difficult to achieve adequate local anaesthesia in these conditions. Management of these conditions may require general anaesthesia.
- **Mentally challenged patients:** In these patients, conduct of dental procedures safely under local anaesthesia could be difficult.
- **Children:** In small children where attempts to use local anaesthesia alone or with conscious sedation has been unsuccessful or the child does not cooperate, dental procedures need to be carried out under general anaesthesia.
- **Patients allergic to local anaesthetics.**
- **Extensive dental procedures.**

General anaesthesia in dental practice

Depending on the health status of the individual and nature of dental procedure to be undertaken, general anaesthesia when indicated can be administered as:

- **Dental chair anaesthesia** (on outpatient basis).
- **Day care anaesthesia** (patient is admitted and discharged on the same day) for oral surgical procedures lasting not more than 1 h.
- **Inpatient anaesthesia** for extensive procedures.

Classification

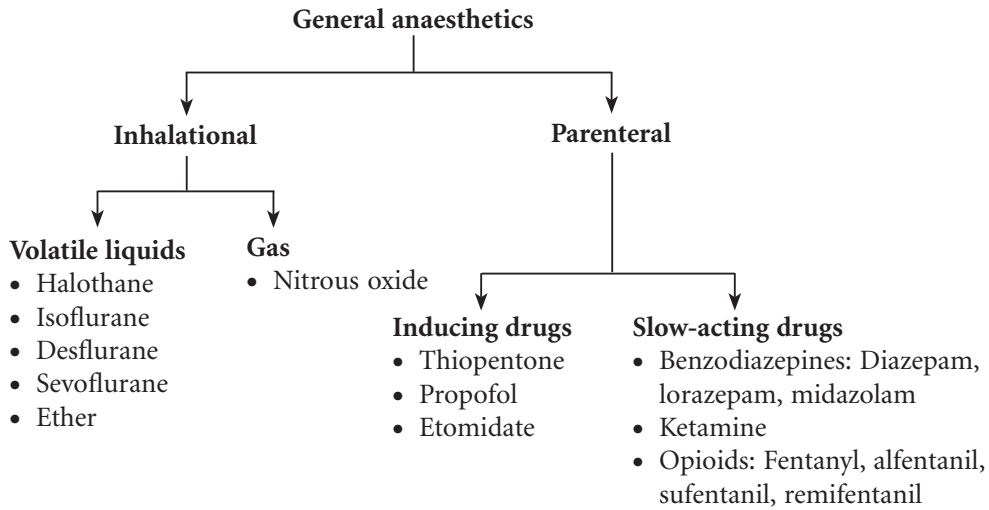

Inhalational Anaesthetics

These are discussed under the following headings (Table 6.4).

1. Gas/volatile liquid
2. Non-inflammable/inflammable
3. Margin of safety
4. Induction and recovery
5. Skeletal-muscle relaxation
6. Analgesia
7. Sensitization of myocardium
8. Hepatotoxicity
9. Irritation of respiratory passages
10. Postoperative nausea and vomiting
11. Other points

Table 6.4 Comparative Features of Ether, Halothane and Nitrous Oxide

Ether	Halothane	Nitrous Oxide
Volatile liquid	Volatile liquid	Gaseous general anaesthetic
Induction and recovery are slow because of its high solubility in blood	Induction and recovery are faster than ether	Induction and recovery are rapid because of low blood solubility
Irritant, inflammable and highly explosive	Non-irritant and non-inflammable	Non-irritant and non-inflammable
Has wide margin of safety	Margin of safety is not wide	Very wide margin of safety
Potent anaesthetic	Potent anaesthetic	Poor anaesthetic
Excellent analgesia	Poor analgesia	Excellent analgesia
Has curarimimetic effect on skeletal muscles, so the dose of d-tubocurarine (d-TC) required is less	Muscular relaxation is inadequate but potentiates the action of d-TC	Poor skeletal muscle relaxant

(Contd....)

Table 6.4 Continued...

Ether	Halothane	Nitrous Oxide
Does not sensitize the heart to catecholamines	Sensitizes the myocardium to catecholamines and may precipitate arrhythmias	Has little effect on heart, respiration and BP
Cheap	Expensive	Cheap
Irritant anaesthetic, increases salivary, respiratory secretions—may induce cough and laryngeal spasm. Therefore, pre-anaesthetic atropine is used to overcome these effects	Causes bronchodilatation—preferred in asthmatics	–
Postoperative nausea and vomiting are common	Nausea and vomiting rare	–
No hepatotoxicity	Hepatotoxicity, especially if used repeatedly (halothane hepatitis)	–
<i>Other points:</i> On exposure to light, it forms ether peroxide, which is an irritant. To avoid this, ether is supplied in amber-coloured bottles covered with black paper. Ether is inflammable and highly explosive; hence electric cautery cannot be used.	<i>Adverse effects: (Note: 'H's')</i> Hypotension: It has direct depressant effect on the myocardium and causes hypotension. Respiratory depression. Both Hepatotoxicity and malignant Hyperthermia are rare. Heart: Halothane sensitizes the myocardium to adrenaline and can cause arrhythmias	Second gas effect and diffusion hypoxia occur with N ₂ O only

Comparative features of halogenated anaesthetics are depicted in Table 6.5.

Table 6.5 Comparative Features of Halogenated Anaesthetics

Halothane	Isoflurane	Desflurane	Sevoflurane
Volatile liquid	Volatile liquid	Volatile liquid	Volatile liquid
Non-inflammable and non-explosive	Non-inflammable and nonexplosive	Non-inflammable and nonexplosive	Non-inflammable and nonexplosive
Induction and recovery are slow	Induction and recovery are rapid than halothane	Induction and recovery are rapid	Induction and recovery are rapid
Hypotension +	Hypotension +	Hypotension +	Hypotension +
Sensitizes the heart to catecholamines and may cause cardiac arrhythmias	–	–	–
Respiratory depression +	Respiratory depression +	Respiratory depression +	Respiratory depression +
Poor muscle relaxant	Skeletal muscle relaxation +	Skeletal muscle relaxation +	Skeletal muscle relaxation +

(Contd...)

Table 6.5 Continued...

Halothane	Isoflurane	Desflurane	Sevoflurane
Non-irritant to respiratory passages, causes bronchodilatation and is preferred in asthmatics	Causes bronchodilatation; irritates air passages	Causes bronchodilatation; irritates air passages	Does not irritate airways and is a potent bronchodilator
Hepatotoxicity on repeated use	No hepatotoxicity	No hepatotoxicity	No hepatotoxicity
<ul style="list-style-type: none"> • Not pungent, well tolerated—preferred for induction and maintenance in children 	<ul style="list-style-type: none"> • Commonly used for maintenance anaesthesia • Pungent odour—hence not commonly used for induction • Does not cause seizures • Can be used for neurosurgical procedures • No renal toxicity 	<ul style="list-style-type: none"> • Irritates airways—not used for Induction • Does not cause seizures • No renal toxicity • Can be used in outpatients because of rapid onset of action and rapid recovery 	<ul style="list-style-type: none"> • Nonirritant to airways—can be used for induction • Suitable for induction and maintenance of anaesthesia in children • Can be used even in outpatients because of rapid recovery • Interacts with soda lime—should not be used in closed circuit system

Halogenated anaesthetics: The newer agents like isoflurane, desflurane and sevoflurane are expensive.
+, Present; –, Absent.

- Use of ether is obsolete but is still in use where there are no other facilities available.
- Halothane sensitizes the myocardium to the arrhythmogenic effects of catecholamines.
- Speed of induction and recovery depends on the solubility of the anaesthetic agent in blood and fat.
- Anaesthetics with low blood solubility produce rapid induction and recovery (e.g. N₂O and desflurane).
- Anaesthetics with high solubility in blood produce slow induction and recovery (e.g. ether).
- **The basis for combining halothane/isoflurane/sevoflurane and nitrous oxide:**
 - a. The minimum alveolar concentration (MAC) of halothane/isoflurane required to produce anaesthesia is reduced when given with N₂O because of second gas effect. As the concentration of halothane/isoflurane required is reduced, the side effects of halothane/isoflurane (hypotension and respiratory depression) are reduced.
Second gas effect: N₂O rapidly diffuses whereas halothane/isoflurane diffuses poorly (Alveoli ↔ Blood ↔ Brain) into the blood. When these (halothane/isoflurane and N₂O) anaesthetics are administered simultaneously, halothane/isoflurane also enters the blood rapidly along with rapidly diffusible gas (N₂O). This is known as 'second gas effect'.
 - b. Because of reduction in the dosage, recovery will be faster.
 - c. Halothane/isoflurane is a potent anaesthetic and poor analgesic whereas N₂O is a good analgesic and poor anaesthetic; hence the combined effect of these two results in potent anaesthesia and good analgesia.

Diffusion hypoxia: Nitrous oxide has low blood solubility – when the administration of N₂O is discontinued; it rapidly diffuses from the blood into the alveoli and causes marked reduction of PaO₂

in the alveoli resulting in hypoxia, which is known as diffusion hypoxia. It can be avoided by giving 100% O₂ for a few minutes immediately after N₂O is discontinued.

Parenteral General Anaesthetics

Inducing Drugs

Thiopentone Sodium (Fig. 6.5)

It is an ultra-short-acting barbiturate. It is a commonly used i.v. anaesthetic for induction of anaesthesia. It is **highly** lipid soluble, hence has a rapid onset and short duration (5–8 min) of action. It is **highly** alkaline (pH 10.5–11), hence **highly** irritant. It should be prepared as a fresh solution before injection. It is injected as 2.5% solution.

After a single i.v. dose, it rapidly enters the **highly** perfused organs like brain, liver, heart, etc. and produces anaesthesia. As blood level of the drug falls rapidly, it diffuses out of the central nervous system into the blood and then to the less-perfused organs like skeletal muscle and adipose tissue. This redistribution results in termination of drug action. Repeated doses will result in accumulation and delayed recovery.

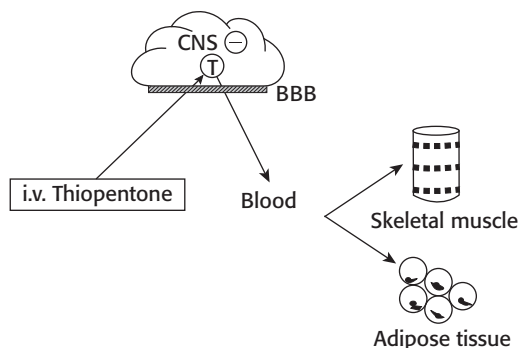

Fig. 6.5 Redistribution of thiopentone: CNS, central nervous system; BBB, blood–brain barrier; T, thiopentone; ⊖, inhibition.

Uses

1. Thiopentone sodium is used for induction of anaesthesia.
2. It is occasionally used as anticonvulsant in cases not controlled by other drugs.

Advantages of thiopentone

1. Rapid induction of anaesthesia and rapid recovery.
2. Does not sensitize the myocardium to circulating catecholamines.

Disadvantages/adverse effects of thiopentone

1. Depresses the respiratory centre.
2. Depresses the vasomotor centre and myocardium.
3. Poor analgesic.
4. Poor muscle relaxant.
5. Causes laryngospasm
6. Accidental intra-arterial injection causes vasospasm and gangrene of the arm.

7. It can precipitate acute intermittent porphyria, hence contraindicated in susceptible individuals (absolute contraindication).

Propofol

It is available as 1% emulsion for intravenous administration. Propofol is a commonly used, popular, rapidly acting anaesthetic.

1. Induction of anaesthesia and recovery are rapid. Residual symptoms are less.
2. Most suitable for out-patient surgical procedures
3. No irritation of air passages.
4. Postoperative nausea and vomiting are rare.
5. Causes respiratory depression and fall in BP.
6. Pain on injection occurs—can be reduced with lignocaine
7. Intravenous propofol is useful for the induction of anaesthesia in adults. Controlled i.v. infusion of propofol can be used for the maintenance of anaesthesia for short procedures.
8. Frequently used to sedate patients in intensive care unit (ICU) who are intubated.

Note: Propofol—Popular, Rapid acting, preferred for **OP** surgical pr**O**cedures, causes **FOL** (fall) in BP.

Slow-acting Drugs

Ketamine

It produces 'dissociative anaesthesia', which is characterized by sedation, amnesia, marked analgesia, unresponsiveness to commands and dissociation from the surroundings. It acts by blocking N-methyl-D-aspartate (NMDA) type of glutamate receptors. It is commonly given by i.v. route; other routes are i.m., oral and rectal. Ketamine is the only i.v. anaesthetic that has **analgesic effect** and causes **sympathetic stimulation**. Heart rate, BP, cardiac output and skeletal muscle tone are usually increased; causes bronchodilatation—suitable for use in asthmatics. It is used in patients with hypovolaemia.

Uses

1. For operations on the head, neck and face.
2. In children for minor surgical and diagnostic procedures.
3. For dressing burn wounds.
4. Combined with diazepam, it has been used in angiographies and cardiac catheterization.

Adverse effects and contraindications

1. Increases BP and heart rate, hence, contraindicated in patients with hypertension and ischaemic heart disease.
2. Increases intracranial pressure.
3. Causes emergence delirium and hallucinations.

Benzodiazepines

Benzodiazepines are slow-acting parenteral anaesthetics. They include diazepam, lorazepam and midazolam. Use of large doses delays recovery and prolongs amnesia. They have poor analgesic effect; do not cause postoperative nausea and vomiting. The effects of BZDs can be reversed by flumazenil. They are useful for angiography, endoscopies, fracture reduction, etc.

Opioid Analgesics

They include fentanyl, alfentanil, sufentanil, remifentanil and pethidine. They are potent analgesics and can be used along with anaesthetics—to decrease the requirement of anaesthetic.

Complications of general anaesthesia

- Hypoxia
- Nausea, vomiting
- Dislocation of temporomandibular joint
- Persisting sedation
- Cardiac arrhythmias, especially with halothane
- Subcutaneous emphysema of face can occur rarely
- Hyperthermia

■ Preanaesthetic Medication

It is the use of drugs before the administration of anaesthetics to make anaesthesia more pleasant and safe.

Objectives/aims of premedication

1. **To reduce anxiety and apprehension:** Benzodiazepines like diazepam, lorazepam or midazolam are preferred because of their sedative, amnesic, calming, anxiolytic effects and wide margin of safety. They reduce anxiety by acting on limbic system.
2. **To prevent vagal bradycardia and reduce salivary secretions caused by anaesthetics:** Antimuscarinic agents such as atropine or glycopyrrolate may be used to reduce salivary and bronchial secretions. They are used to prevent vagal bradycardia and hypotension. They also prevent laryngospasm by reducing respiratory secretions. Glycopyrrolate is preferred because it rarely causes CNS effects.
3. **To relieve pre- and postoperative pain:** Opioid analgesics such as morphine, pethidine or fentanyl may be used to relieve pain. NSAIDs like diclofenac can also be used.
4. **For antiemetic effect:** Metoclopramide, domperidone or ondansetron may be used to control vomiting.
5. **To prevent acid secretion and stress ulcer:** H₂-Blocker such as ranitidine or proton-pump inhibitor like omeprazole may be used to reduce gastric acid secretion especially before prolonged surgery.
6. **To hasten gastric emptying before emergency surgery:** Metoclopramide or domperidone may be used. They are prokinetic drugs—increase the tone of lower oesophageal sphincter and accelerate gastric emptying, thus prevent aspiration pneumonia.

■ Conscious Sedation

Conscious sedation is a level of CNS depression where a patient does not lose consciousness but is able to communicate and cooperate during the procedure/treatment.

Indications

- Uncooperative patients.
- Anxious patients.
- Emotionally compromised patients.

Conscious sedation should be avoided in:

- Chronic obstructive pulmonary disease.
- Pregnancy.
- Prolonged surgery.
- Psychoses.

Drugs used

1. Benzodiazepines

- Diazepam is the most commonly used drug for conscious sedation. Small doses (1–2 mg) of diazepam is administered intravenously slowly. It can also be administered orally.
- Midazolam is a short-acting benzodiazepine given intravenously.
- Temazepam is given orally. It is safe and has better patient compliance.

2. **Nitrous oxide + Oxygen:** Nitrous oxide is given by inhalational route along with 100% oxygen.

3. **Chloral hydrate** (orally), **propofol** (i.v. infusion), **fentanyl** (i.v.), etc. can also be used for conscious sedation.

Precautions

- Written, informed consent should be obtained from the patient prior to the procedure.
- Conscious sedation should be administered by trained personnel.
- Constant monitoring of the vital signs should be done during and after the procedure.
- The procedure should be documented. Postoperative instructions should be in written form.
- Equipment and emergency drugs should be kept ready to tackle any emergency.
- Patient should be escorted by an attendant.

Key Points for Dentists

- Written informed consent should be obtained from the patient prior to the procedure.
- Monitor vital signs when the patient is under the influence of anaesthetics.
- Constant monitoring of vital signs should be continued after the procedure.
- Equipment and emergency drugs should be kept ready to tackle any emergency.
- Patient should be escorted by an attendant.
- The entire procedure should be documented. Postoperative instructions should be in written form.
- Ketamine should be avoided in epileptics (can precipitate seizures) and in patients with history of psychiatric disorder.
- Thiopentone can cause respiratory depression.
- Sevoflurane/halothane along with nitrous oxide and oxygen can be used for induction and maintenance of anaesthesia in children and adults.
- Isoflurane along with nitrous oxide and oxygen can be used for maintenance of anaesthesia.

LOCAL ANAESTHETICS

Local anaesthetics (LAs) are the drugs that, when applied topically or injected locally, block nerve conduction and cause reversible loss of all sensation in the part supplied by the nerve. The order of blockade of nerve function proceeds in the following manner—pain, temperature, touch, pressure and finally skeletal muscle power.

Chemistry (Fig. 6.6)

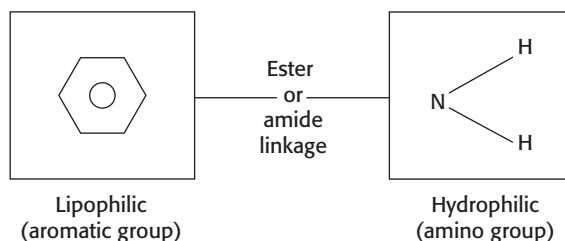

Fig. 6.6 Basic structure of local anaesthetics.

Local anaesthetics are weak bases. They consist of three parts: (i) hydrophilic amino group, (ii) lipophilic aromatic group and (iii) intermediate ester or amide linkage.

Classification of local anaesthetics

1. According to clinical use

a. Surface anaesthetics

Cocaine, lignocaine, tetracaine, benzocaine, oxethazaine, benoxinate, butylaminobenzoate, dyclonine.

b. Injectable anaesthetics

i. *Short acting with low potency*: Procaine, chlorprocaine.

ii. *Intermediate acting with intermediate potency*: Lignocaine, mepivacaine, prilocaine.

iii. *Long acting with high potency*: Tetracaine, bupivacaine, dibucaine, ropivacaine.

2. According to structure

a. *Esters**: Cocaine, procaine, chlorprocaine, benzocaine, tetracaine.

b. *Amides**: Lignocaine, mepivacaine, bupivacaine, prilocaine, articaine, ropivacaine.

Mechanism of action

Main site of action of local anaesthetics is the cell membrane. The LAs in 'unionized' form easily penetrate the nerve sheath and the axon membrane. Within the axoplasm, the molecules become 'ionized' and block the voltage-gated Na^+ channels.

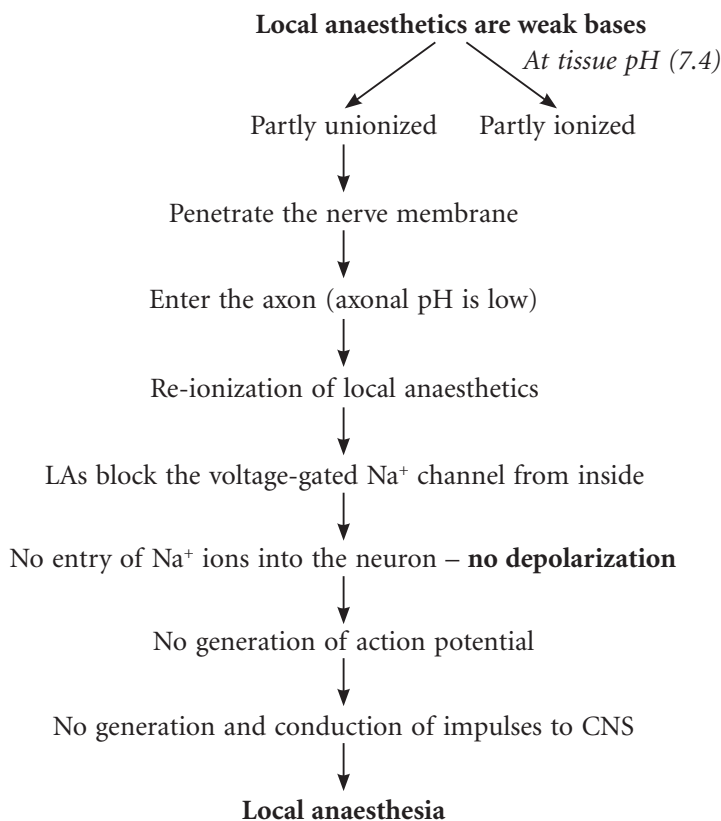

*Note: Esters have one 'i'; amides have two 'i' (i...i).

- Action of local anaesthetic is pH dependent and the penetrability of LA is increased at alkaline pH (i.e. when the unionized form is more). Penetrability is very poor at acidic pH. In infected tissues, pH is low, which causes ionization of the drug. This reduces the penetration of LA through the cell membrane, thus decreases the effectiveness of LAs. Therefore, LAs are **less effective in inflamed and infected areas**.
- Diameter of nerve fibres: LAs block small fibres first followed by larger fibres.
- Myelinated fibres are blocked earlier than nonmyelinated nerve of the same diameter.
- Sensory fibres are blocked earlier than motor fibres because of their high firing rate and longer duration of action potential.
- Fibres in the centre are blocked later than ones located in the circumference of the nerve bundle.

Factors affecting local anaesthetic action

1. **pKa:** Higher the pKa, more is the ionized fraction of the drug at physiological pH. Hence, onset of action is slow and vice versa. For example, the pKa of procaine is 9.1, hence, it has slow onset of action; whereas the pKa of lignocaine is 7.7—it has rapid onset of action.
2. **Degree of plasma protein binding:** Higher the plasma protein binding, longer the duration of action of the drug, e.g. procaine is poorly bound to plasma proteins, hence has a short duration of action; whereas bupivacaine is highly bound and has a longer duration of action.
3. **Rate of diffusion from the site of administration:** It depends on the initial concentration gradient of the drug. Higher the concentration, rapid is the onset of action.
4. **Lipid solubility:** Higher the lipid solubility more is the potency of the drug, e.g. lignocaine is more potent than procaine as it is more lipid soluble.
5. **Presence of vasoconstrictor:** Prolongs the duration of local anaesthetics. The commonly used vasoconstrictor with local anaesthetics is adrenaline. Others are phenylephrine, felypressin, etc.

Combination of vasoconstrictor with local anaesthetic

The commonly used vasoconstrictor with a local anaesthetic is adrenaline. **Addition of a vasoconstrictor (e.g. adrenaline) to the LA has the following advantages:**

1. Slow absorption from the local site, which results in prolonged duration of action of local anaesthesia.
2. Decreased bleeding in the surgical field.
3. Slow absorption of LA reduces its systemic toxicity.

Disadvantages and contraindications of combining vasoconstrictor with LA:

1. Intense vasospasm and ischaemia in tissues with end arteries may cause gangrene of the part (e.g. fingers, toes, penis, ear lobule, tip of the nose, etc.). Hence, use of vasoconstrictors is contraindicated in these sites.
2. Absorption of adrenaline can cause systemic toxicity—tachycardia, palpitation, rise of BP and precipitation of angina or cardiac arrhythmias. Hence, combined preparation (LA with adrenaline) should be avoided in patients with hypertension, congestive cardiac failure (CCF), arrhythmias, ischaemic heart disease and uncontrolled hyperthyroidism.
3. May delay wound healing by reducing the blood flow to the affected area.

Felypressin: It is a synthetic analogue of vasopressin. It can also be used with local anaesthetic to prolong the duration of action. It may be safely used with a local anaesthetic in patients with hyperthyroidism, cardiovascular diseases and those receiving monoamine oxidase (MAO) inhibitors or tricyclic antidepressants. It is contraindicated in pregnant patients because of its oxytocic (uterine stimulant) action on the uterus.

Pharmacological actions

1. *Nervous system*

- a. *Peripheral nerves*: The order of nerve fibres affected is autonomic fibres, pain, temperature, touch, pressure and motor fibres.
- b. *CNS*: Most of the LAs cross the blood–brain barrier (BBB)—initially they cause CNS stimulation and then depression in higher doses. They cause excitement, tremor, twitching, restlessness and convulsions. Large doses can cause respiratory depression, coma and death.

2. *Cardiovascular system*

- a. *Heart*: LAs, by blocking Na⁺ channels, decrease abnormal pacemaker activity, contractility, conductivity, excitability, heart rate, cardiac output and increase effective refractory period.
 - At higher concentrations, the intravenous administration of LAs may precipitate cardiac arrhythmias.
 - Bupivacaine is more cardiotoxic than other LAs—may cause cardiovascular collapse and death.
 - Lignocaine decreases automaticity and is useful in ventricular arrhythmias.
- b. *Blood vessels*: Local anaesthetics produce hypotension due to vasodilatation and myocardial depression.

Pharmacokinetics

Most of the ester-linked LAs are rapidly metabolized by plasma cholinesterase whereas amide-linked drugs are metabolized mainly in liver. LAs (procaine, lignocaine, etc.) are not effective orally because of high first-pass metabolism. In liver diseases, the metabolism of lignocaine may be impaired; hence dose must be reduced accordingly.

Adverse effects

1. **Central Nervous System (CNS)**: LAs initially cause CNS stimulation followed by depression. They are restlessness, tremor, headache, drowsiness, confusion and convulsions followed by respiratory depression, coma and death.
2. **CVS**: Bradycardia, hypotension, cardiac arrhythmias, rarely cardiovascular collapse and death. Bupivacaine is highly cardiotoxic.
3. **Allergic reactions**: These are skin rashes, itching, erythema, urticaria, wheezing, bronchospasm and rarely anaphylactic reaction. The incidence of allergic reactions is more with ester-linked LAs than with amide-linked LAs.
4. Mucosal irritation (cocaine) and methaemoglobinaemia (prilocaine) may be seen.
5. Methylparaben, a preservative in LA solutions, may cause allergic reactions.

■ Some Important Local Anaesthetics (Table 6.6)

Tetracaine

An ester type of LA; has long duration but slow onset of action. It is rarely used for spinal anaesthesia because of its longer duration of action.

Bupivacaine

It is a widely used LA. It is potent and has a long duration of action. It produces more sensory than motor blockade; hence it is very popular for obstetric analgesia. It is highly cardiotoxic and may precipitate ventricular arrhythmias.

Ropivacaine

It is less potent and less cardiotoxic than bupivacaine. Its duration of action is similar to bupivacaine. It is used for both epidural and regional anaesthesia.

Table 6.6 Properties of Local Anaesthetics

Drug	Group	Duration of Action (min)	Potency	Onset	Tissue Penetrability	Other Points
Procaine	Ester	15–30 (short)	Low	Slow	Poor	No surface anaesthesia
Chloroprocaine	Ester	15–30 (short)	Low	Rapid	–	–
Tetracaine	Ester	120–240 (long)	High	Very slow	Moderate	<ul style="list-style-type: none"> • Widely used in spinal and corneal anaesthesia • High systemic toxicity because of slow metabolism
Cocaine	Ester	–	–	Intermediate	Good	<ul style="list-style-type: none"> • Inhibits the reuptake of NA in both central and peripheral nerves • Causes tachycardia, rise of BP, mydriasis and euphoria • Rarely used, only as topical anaesthetic for upper respiratory tract
Lignocaine	Amide	30–60 (intermediate)	Intermediate	Rapid	Good	<ul style="list-style-type: none"> • Most widely used local anaesthetic; also used in ventricular arrhythmias. • Used topically for aphthous ulcers and oral mucositis.
Mepivacaine	Amide	45–90 (intermediate)	Intermediate	Intermediate	–	<ul style="list-style-type: none"> • No surface anaesthesia
Bupivacaine	Amide	120–240 (long)	High	Intermediate	Moderate	<ul style="list-style-type: none"> • Highly cardiotoxic, widely used for spinal, epidural, infiltration and nerve block—because of the long duration of action
Ropivacaine	Amide	120–360 (long)	Intermediate	Intermediate	Moderate	<ul style="list-style-type: none"> • Similar to bupivacaine, less cardiotoxic
Prilocaine	Amide	Intermediate	–	Intermediate	Moderate	<ul style="list-style-type: none"> • Widely used, can cause methaemoglobinaemia
Dibucaine	Amide	180–600 (long)	High	Slow	Good	<ul style="list-style-type: none"> • Useful as topical anaesthetic for anal mucous membrane
Articaine	Amide	60	–	Rapid	–	<ul style="list-style-type: none"> • Used in dentistry for infiltration and nerve block anaesthesia; can cause methaemoglobinaemia, paraesthesia, neuropathy

Prilocaine

It is an amide type of LA. It has intermediate onset and duration of action. It has poor vasodilatory effect, hence can be used without a vasoconstrictor. It is mainly used for infiltration and i.v. regional anaesthesia.

Table 6.7 Comparative Features of Esters and Amides

Ester Type of Local Anaesthetic, e.g. Procaine	Amide Type of Local Anaesthetic, e.g. Lignocaine
Short acting	Intermediate acting
Has poor tissue penetrability, hence no surface anaesthetic effect	Has good tissue penetrability
Has slow onset of action	Has rapid onset of action
Is metabolized by plasma cholinesterase	Is metabolized by hepatic microsomal enzymes
Allergic reactions are common with esters	Allergic reactions are rare
Useful for infiltration and nerve block anaesthesia; at present, it is rarely used	Widely used for all types of anaesthesia—spinal, epidural, i.v. regional block, nerve block, infiltration and surface anaesthesia

Articaine

It is an amide local anaesthetic used in dentistry for infiltration and nerve block anaesthesia. It acts rapidly and has a duration of action of 1 h. It is expensive. It is also available with adrenaline. The adverse effects are methaemoglobinaemia, paraesthesia and neuropathies.

Eutectic Mixture [EMLA—Eutectic Mixture of Local Anaesthetics: Lignocaine (2.5%) and Prilocaine (2.5%)]

The melting point of the mixture is less than that of either compound alone. It can penetrate intact skin. EMLA has to be applied 1 h before the procedure and is used for dermal anaesthesia during venesection and skin graft procedures. It should not be used on mucous membranes or abraded skin. It is contraindicated in patients with methaemoglobinaemia and infants.

Dibucaine

It is a very potent, highly toxic and the longest-acting LA. It is rarely used for spinal anaesthesia; is also available for topical application on mucous membrane and skin.

Benoxinate

It is a surface anaesthetic; useful for corneal anaesthesia.

Benzocaine and butylaminobenzoate

Surface anaesthetics; cause minimal systemic toxicity; available as ointment and lozenges; used for haemorrhoids, anal fissure and sore throat.

Oxethazaine

It is a topical anaesthetic and is used to anaesthetize gastric mucosa. It produces symptomatic relief in gastritis. It is available in combination with antacids.

Dyclonine

It is used topically to relieve pain of radiation/chemotherapy induced oral mucositis.

■ Techniques of Local Anaesthesia (Table 6.8)

◆ Surface Anaesthesia (Topical Anaesthesia)

Local anaesthetic is applied on the abraded skin and mucous membrane of oral cavity, nose, eyes, throat, upper respiratory tract, oesophagus, urethra, ulcers, burns, etc. Tetracaine 2%, lignocaine 2–10%, benzocaine 1–2%, etc. are used for topical application. Surface anaesthetics are available as solution, ointment, gel, patch, cream, spray, lozenges, etc.

Addition of adrenaline does not prolong the duration of surface anaesthesia because of poor penetration. Topical anaesthetics are useful before injecting a local anaesthetic, subgingival and periodontal scaling.

Table 6.8 Methods of Administration and Uses of Local Anaesthetics

LA Technique	Drugs	Therapeutic Application (Uses)
Surface anaesthesia (topical)	<ul style="list-style-type: none"> • Lignocaine (2–10%) • Tetracaine (2%) • Benzocaine 	To anaesthetize mucous membrane of oral cavity before injecting local anaesthetic, subgingival and periodontal scaling
Infiltration anaesthesia	Most of the anaesthetics <ul style="list-style-type: none"> • Lignocaine (0.5–1%) • Procaine (0.5–1%) • Bupivacaine (0.125–0.25%) • Ropivacaine 	<ul style="list-style-type: none"> • Abscess drainage • Excision of small swellings • Suturing of cut wounds • Before root canal treatment— interproximal papillary infiltration • Gingivectomy
Field block	<ul style="list-style-type: none"> • Lignocaine (0.5–1%) • Bupivacaine (0.125–0.25%) 	<ul style="list-style-type: none"> • Maxillary injections above the apex of tooth to be treated
Nerve block anaesthesia	Most of the anaesthetics	<ul style="list-style-type: none"> • Maxillary nerve block for palatal, buccal and pulpal management in one quadrant • Anterior superior alveolar nerve block for management of anterior teeth in one quadrant

◆ Infiltration Anaesthesia

Local anaesthetic is injected directly into tissues to be operated; it blocks small sensory nerve endings in the area. Local anaesthetics are also infiltrated into the skin, subcutaneous tissue or deeper structures. The most frequently used LAs for infiltration are lignocaine (0.5–1%), articaine, procaine (0.5–1%) and bupivacaine (0.125–0.25%). Addition of adrenaline to LA (1:50,000–250,000) prolongs the duration of anaesthesia.

Infiltration anaesthesia is suitable only for small areas. The main disadvantage of infiltration is the requirement of large amounts of the drug to anaesthetize relatively small area. It can be used for drainage of an abscess, gingivectomy, excision of small swelling, suturing of cut wounds, before root canal treatment (interproximal papillary infiltration), etc. Infiltration anaesthesia is contraindicated, if there is local infection and clotting disorders.

Conduction Block

1. Field block anaesthesia

It is achieved by injecting the local anaesthetic near the apex of the tooth—blocks larger terminal nerve endings at the apex. For example, LA is injected into the maxillary region above the apex of tooth to be treated to produce field block. This technique is also used in case of minor procedures of scalp, anterior abdominal wall, upper and lower extremities in which a smaller dose produces larger area of anaesthesia.

2. Nerve-block anaesthesia

Local anaesthetic is injected very close to or around the peripheral nerve or nerve plexuses. It produces larger areas of anaesthesia than field block.

- Maxillary nerve block: For palatal, buccal and pulpal procedures in one quadrant.
- Anterior superior alveolar nerve block: Management of anterior teeth in one quadrant.
- Middle superior alveolar nerve block: For procedures involving premolars in one quadrant.
- Inferior alveolar nerve block: Management of multiple mandibular teeth in one quadrant.
- Buccal nerve block: To anaesthetize buccal soft tissue in the mandibular molar region.

In nerve block anaesthesia, the requirement of LA is less than that of field block and infiltration anaesthesia.

Complications of local anaesthesia

In addition to drug-related adverse effects mentioned above, other complications are:

- Paraesthesia—resulting in trauma to soft tissues due to biting of lips and cheek.
- Pain due to nerve injury and haematoma.
- Facial nerve paralysis following nerve block. Patient should be reassured that it is temporary.

Spinal Anaesthesia

It is one of the most popular forms of anaesthesia. Local anaesthetic is injected into the subarachnoid space to anaesthetize spinal roots.

Site of injection

Spinal anaesthetic is injected into the space between L₂₋₃ and L₃₋₄ below the lower end of the spinal cord. The level of anaesthesia is influenced by: (i) site of injection, (ii) amount of fluid injected, (iii) force of injection, (iv) specific gravity of the drug solution [hyperbaric (in 10% glucose), hypobaric (in distilled water) or isobaric] and (v) position of the patient—lying prone/lateral or tilted with head-down position.

Commonly used LAs for spinal anaesthesia

They are lignocaine, tetracaine, bupivacaine, etc. Addition of adrenaline to spinal anaesthetic increases the duration or intensity of block.

Uses

Spinal anaesthesia can be used for surgical procedures below the level of umbilicus, i.e. lower limb surgery, caesarean section, obstetric procedures, surgery on perineum, appendectomy, etc.

Complications

1. Headache is due to the seepage of CSF and can be reduced by using very fine needles.
2. Hypotension is due to blockade of sympathetic vasoconstrictor fibres to blood vessels. Venous return to the heart is reduced due to paralysis of skeletal muscles in the legs. Hypotension is treated by raising the foot-end and with sympathomimetics such as ephedrine, mephentermine, phenylephrine, etc.
3. Respiratory paralysis: It is due to the paralysis of intercostal muscles. Respiratory failure may occur due to respiratory centre ischaemia as a result of hypotension.
4. Septic meningitis and nerve injury are extremely rare at present because of good anaesthetic practice.
5. Postoperative urinary retention may occur.

Contraindications

The contraindications are young children, vertebral abnormalities, sepsis in the region of lumbar puncture site, hypotension and shock.

► Epidural Anaesthesia

Local anaesthetic is injected into epidural space, where it acts on spinal nerve roots. Lignocaine and bupivacaine are commonly used. It is safer, but the technique is more difficult than spinal anaesthesia. Epidural anaesthesia is slower in onset than spinal anaesthesia. It requires a much larger amount of the drug. It is useful in obstetric analgesia.

■ Drug Interactions

1. **Lignocaine × propranolol:** Propranolol by reducing hepatic blood flow, impairs the clearance of lignocaine, which may result in toxicity.
2. **Procaine × sulphonamides:** Procaine is hydrolysed to PABA—reduces the effect of sulphonamides.
3. **Lignocaine with adrenaline × tricyclic antidepressants:** Can precipitate hypertensive crisis.
4. **Lignocaine with adrenaline × propranolol:** Dangerous rise in BP due to unopposed alpha action of adrenaline.

Key Points for Dentists

- Ask for history of drug allergy.
- Check the local anaesthetic preparation for its concentration before use.
- Combined preparation (local anaesthetic with adrenaline) should be avoided in patients with hypertension, CCF, arrhythmias, ischaemic heart disease and uncontrolled hyperthyroidism.
- Lignocaine with adrenaline should not be used to anaesthetize fingers, toes, penis, ear lobule, tip of the nose, etc.
- Lignocaine is available as a solution for injection (plain and with adrenaline); for topical, solution, cream, gel, spray, ointment, jelly, patch, etc.
- Eutectic mixture (EMLA) should not be applied on abraded skin and mucous membrane.
- Care should be taken to avoid accidental intravenous injection of the local anaesthetic during the technique.

ALCOHOLS (ETHANOL AND METHANOL)

The actions of alcohol are depicted in Fig. 6.7.

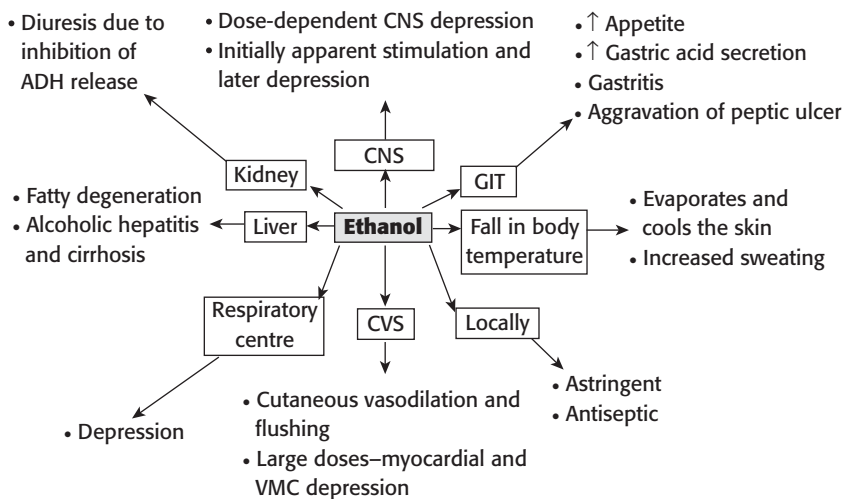

Fig. 6.7 Actions of alcohol. CNS, central nervous system; ADH, antidiuretic hormone; VMC, vasomotor centre (medulla); CVS, cardiovascular system; GIT, gastrointestinal tract.

Therapeutic uses of alcohol

1. **Antiseptic:** 70% alcohol is used as an antiseptic.
2. **Trigeminal and other neuralgias:** Injection of alcohol directly into nerve trunk relieves pain by destroying them.
3. **Prevent bedsores:** Alcohol is used locally to prevent bedsores in bedridden patients.
4. **Methanol poisoning** (see p. 167): Ethanol competes with methanol for metabolic enzymes and saturates them. Hence, prevents the formation of toxic metabolites of methanol (formaldehyde and formic acid).
5. **Fever:** Alcoholic sponges are useful to reduce body temperature.

■ Acute Ethanol Overdosage (Acute alcohol Intoxication)

The signs and symptoms of acute alcohol intoxication are drowsiness, nausea, vomiting, ataxia, hypotension, respiratory depression, hypoglycaemia, etc.

Treatment (Note: A–G)

It is a medical emergency. The main aim of therapy is to prevent severe respiratory depression and aspiration of vomitus.

1. Maintain **A**irway, **B**reathing, **C**irculation, **G**astric lavage, **F**luid and **E**lectrolyte balance.
2. Intravenous **G**lucose to correct hypoglycaemia.
3. Thiamine is administered as i.v. infusion in glucose solution.
4. Haemo**D**ialysis helps to hasten the recovery.

■ Chronic Alcoholism

Drug treatment of chronic alcoholism.

1. **Psychotherapy, occupational therapy and rehabilitation.**
2. **Drug therapy**

- a. **Disulfiram (alcohol aversion therapy):** It causes aversion to alcohol.

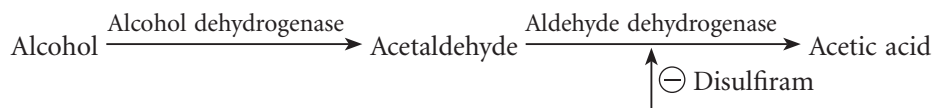

Disulfiram inhibits aldehyde dehydrogenase and causes accumulation of acetaldehyde in blood and tissues (acetaldehyde syndrome). The signs and symptoms include nausea, vomiting, flushing, headache, sweating, tachycardia, palpitation, breathlessness, chest pain, hypotension, hypoglycaemia, confusion, shock and even death. This reaction is unpleasant; hence the person on disulfiram develops aversion to alcohol.

Drugs like metronidazole, griseofulvin, cefoperazone, chlorpropamide, etc. also have disulfiram-like action and produce similar reaction with alcohol. Hence, doctors should warn the patient not to take alcohol when they are on the above mentioned drugs.

- b. **Naltrexone (opioid antagonist):** It reduces alcohol craving and helps to maintain abstinence.
 c. **Acamprosate:** It is an analogue of GABA and decreases consumption of alcohol.
 d. **Ondansetron (5-HT₃ antagonist):** It reduces alcohol consumption.

■ Methanol Poisoning (Methyl Alcohol Poisoning)

This occurs when methylated spirit is consumed or when liquor is adulterated with methyl alcohol. Methanol is a mild CNS depressant. It is metabolized to formaldehyde and formic acid, which in turn causes metabolic acidosis and injury to the retina. The signs and symptoms of methanol poisoning are nausea, vomiting, abdominal pain, headache, vertigo, confusion, hypotension, convulsions and coma. Metabolic acidosis is due to formic acid, which also causes dimness of vision, retinal damage and blindness.

Treatment

1. Patient is kept in a dark room to protect the eyes from light.
2. Maintain airway, breathing and circulation.
3. Gastric lavage is done after endotracheal intubation.
4. Intravenous sodium bicarbonate is given to correct acidosis.
5. Ethanol (10%) is administered via nasogastric tube. Ethanol competes with methanol for the metabolic enzymes and saturates them, thus preventing the formation of toxic metabolites (formaldehyde and formic acid). Methanol is excreted unchanged in urine and breath.

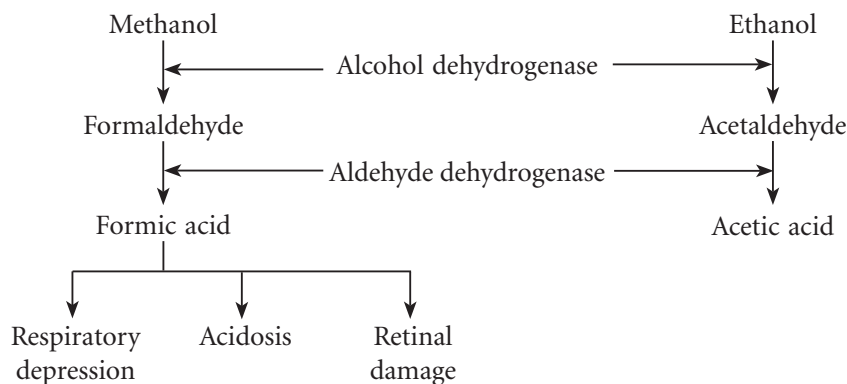

6. Haemodialysis is done to promote the excretion of methanol and its toxic metabolites.
7. Fomepizole, an alcohol dehydrogenase inhibitor, is used in the treatment of methanol and ethylene glycol poisoning.
8. Calcium leucovorin is administered intravenously to enhance the metabolism of formate, thereby decreasing its levels.

Key Points for Dentists

- 70% ethanol is used as an antiseptic.
- Small amount of kerosene or methanol is added to denature spirit (70% ethanol) and to make it unfit for consumption.
- Alcohol causes dose-dependent CNS depression; hence driving should be avoided under the effect of alcohol.
- Alcoholics are more prone to get drug toxicities like:
 - Hepatotoxicity with paracetamol.
 - Peptic ulcer and gastric bleeding with aspirin.
- Metronidazole and some of the cephalosporins may cause disulfiram-like reaction with alcohol; hence the patient should be advised to refrain from alcohol.

ANTIEPILEPTIC DRUGS

Epilepsy is a Greek word that means convulsions. Epilepsy is a disorder of brain function characterized by paroxysmal cerebral dysrhythmia. Major types of epilepsies are shown below.

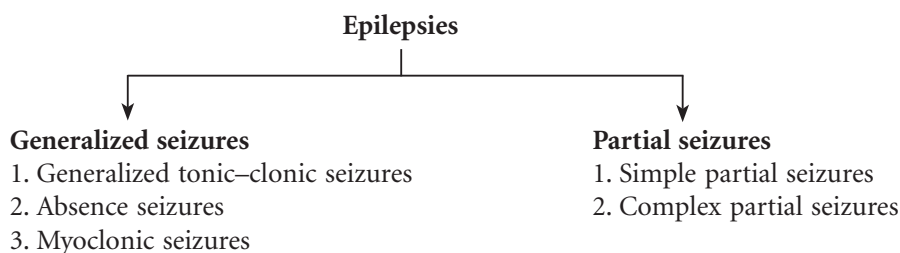

Generalized seizures

1. **Generalized tonic-clonic seizures (GTCS, grand mal epilepsy)**: It is characterized by the following sequence of symptoms: Aura–epileptic cry–loss of consciousness–fall to the ground–tonic phase–clonic phase–period of relaxation–postepileptic automatism with confusional states.
2. **Absence seizures (petit mal epilepsy)**: It is characterized by sudden onset of staring, unresponsiveness with momentary loss of consciousness.
3. **Myoclonic seizures**: It consists of single or multiple sudden, brief, shock-like contractions.

Partial seizures

1. **Simple partial seizures (SPS)**: The manifestations depend on the region of cortex involved. There may be convulsions (focal motor symptoms) or paraesthesia (sensory symptoms) without loss of consciousness.
2. **Complex partial seizures (CPS, temporal lobe epilepsy, psychomotor epilepsy)**: It is characterized by aura–amnesia–abnormal behaviour and automatism with impaired consciousness.

Chemical classification of antiepileptic drugs

1. **Hydantoins**: Phenytoin, fosphenytoin.
2. **Barbiturate**: Phenobarbitone.

3. **Iminostilbenes:** Carbamazepine, oxcarbazepine.
4. **Succinimide:** Ethosuximide.
5. **Benzodiazepines:** Diazepam, lorazepam, clonazepam, clobazam.
6. **Carboxylic acid derivative:** Valproic acid (sodium valproate).
7. **Others:** Vigabatrin, lamotrigine, acetazolamide, gabapentin, pregabalin, topiramate, zonisamide, tiagabine, levetiracetam.

Clinical classification of antiepileptic drugs

The classification of antiepileptic drugs is presented in Table 6.9.

Table 6.9 Antiepileptic Drugs: Clinical Classification

Seizure Type	Preferred Drugs	Alternative Drugs
Generalized tonic–clonic seizures (grand mal epilepsy)	Carbamazepine Sodium valproate Phenytoin Phenobarbitone	Lamotrigine Topiramate Primidone
Simple partial seizures (SPS)	Carbamazepine Phenytoin Sodium valproate	Gabapentin, Lamotrigine, Topiramate, Tiagabine, Levetiracetam, Zonisamide
Complex partial seizures (CPS)	Carbamazepine Sodium valproate Phenytoin	Gabapentin, Lamotrigine, Topiramate, Tiagabine, Levetiracetam, Zonisamide
Absence seizures (petit mal epilepsy)	Sodium valproate Ethosuximide	Clonazepam Lamotrigine
Myoclonic seizures	Sodium valproate	Clonazepam Lamotrigine Topiramate
Status epilepticus	Lorazepam Diazepam Fosphenytoin, Phenobarbitone	General anaesthetics— midazolam, propofol

Mechanism of action of antiepileptic drugs has been depicted in Figures 6.8a and b.

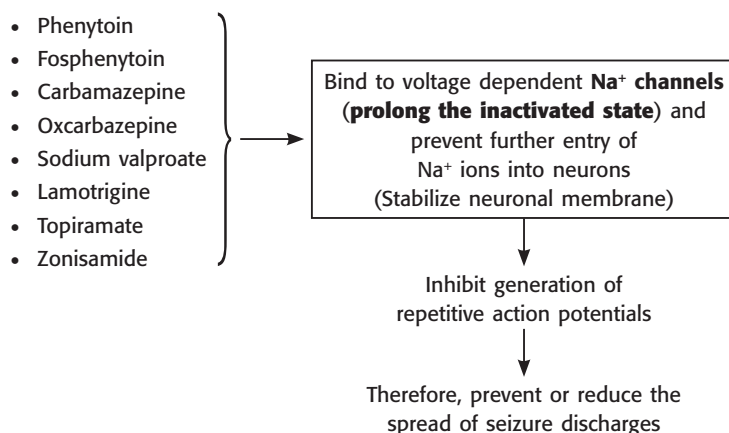

Fig. 6.8(a) Mechanism of action of antiepileptic drugs: effect on sodium channels.

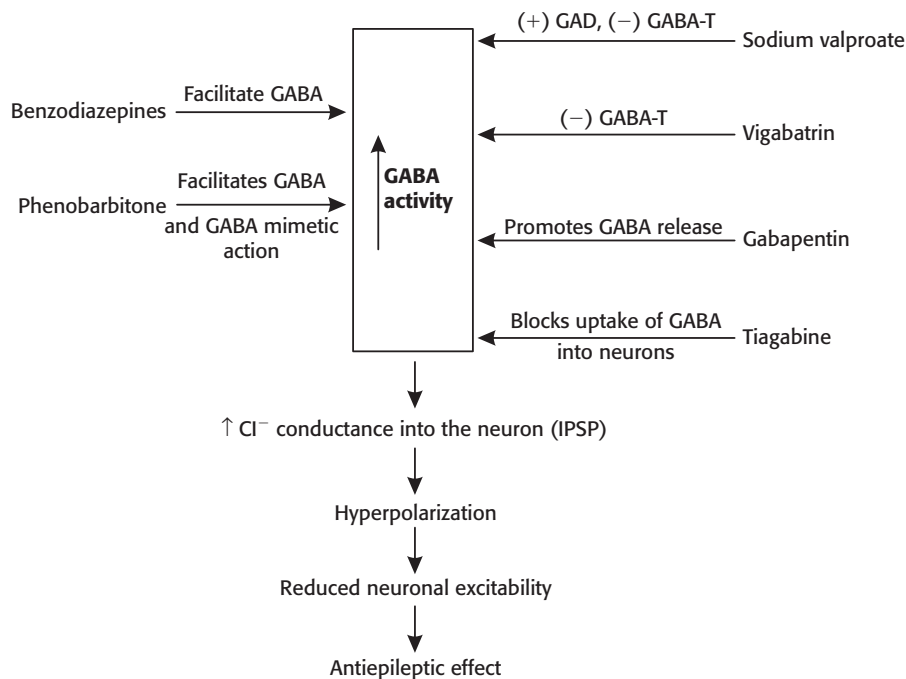

Fig. 6.8(b) Mechanism of action of antiepileptics: effect on GABA. GAD, glutamic acid decarboxylase; GABA-T, GABA transaminase; IPSP, inhibitory postsynaptic potential.

■ Phenytoin (Diphenylhydantoin)

Phenytoin is one of the most commonly used antiepileptic drugs. It has a selective antiepileptic effect and does not produce significant drowsiness.

Mechanism of action

Phenytoin acts by stabilizing the neuronal membrane (Fig. 6.9) and prevents spread of seizure discharges. The sodium channels exist in three forms: resting, activated and inactivated states. Phenytoin delays recovery of Na^+ channels from inactivated state, thereby reduces the neuronal excitability (Fig. 6.9).

At high concentrations, phenytoin inhibits Ca^{2+} influx into the neuron, reduces glutamate levels and increases responses to GABA.

Pharmacokinetics

Phenytoin is absorbed slowly through the GI tract, widely distributed and highly (about 90%) bound to plasma proteins. It is almost completely metabolized in liver by hydroxylation and glucuronide conjugation. Repeated administration of phenytoin causes enzyme induction and increases the rate of metabolism of co-administered drugs. Phenytoin exhibits dose-dependent elimination or saturation kinetics, i.e. at low concentration, elimination occurs by first-order kinetics; as the concentration increases, the metabolizing enzymes get saturated and kinetics changes to zero order. The plasma $t_{1/2}$ of phenytoin increases from 24 h to 60 h. The plasma concentration increases disproportionately with

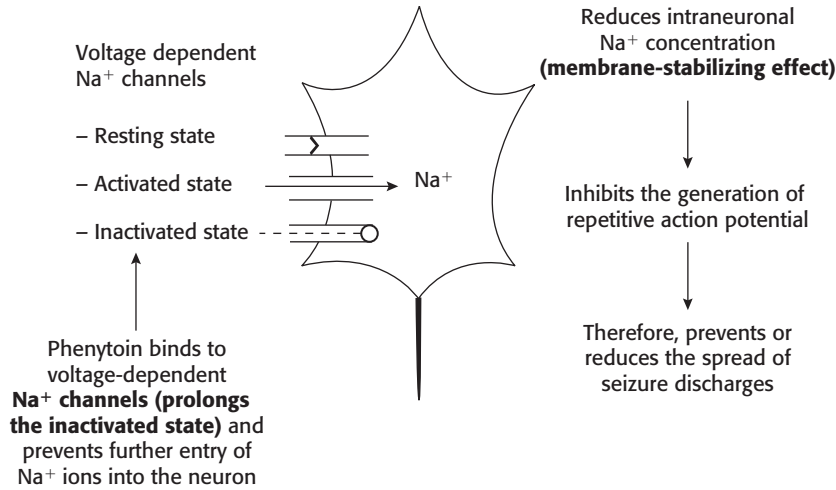

Fig. 6.9 Mechanism of action of phenytoin.

slight increase in dose, resulting in toxicity. Hence, therapeutic monitoring of phenytoin is essential for adjustment of dosage.

Uses

Phenytoin is used for the treatment of:

1. Generalized tonic–clonic seizures (grand mal epilepsy).
2. Partial seizures.
3. Trigeminal and other neuralgias.
4. Status epilepticus: Phenytoin is administered intravenously in normal saline (it precipitates in glucose).

Adverse effects (Note the ‘H’s)

Phenytoin has dose-dependent toxicity. The adverse effects are:

1. **H**ypertrophy and **H**yperplasia of gums: Seen on chronic therapy and can be minimized by proper oral hygiene.
2. **H**ypersensitivity reactions include skin rashes, neutropaenia and rarely **H**epatic necrosis.
3. **H**irsutism: Due to increased androgen secretion.
4. **H**yperglycaemia: Due to decreased insulin release.
5. Megaloblastic anaemia: Due to folate deficiency.
6. Osteomalacia: Due to increased metabolism of vitamin D.
7. **H**ypocalcaemia: Due to decreased absorption of Ca²⁺ from the gut.
8. Foetal **H**ydantoin syndrome: Cleft lip, cleft palate, digital **H**ypoplasia, etc. due to the use of phenytoin during pregnancy.

At high concentrations, phenytoin may cause the following side effects:

1. **CNS:** Vestibulocerebellar syndrome—vertigo, ataxia, tremor, headache, nystagmus, psychological disturbances, etc. occur on chronic therapy.
2. **GIT:** Nausea, vomiting and dyspepsia can be minimized by giving phenytoin after food.
3. **CVS:** Hypotension and cardiac arrhythmias may occur on i.v. administration.

Fosphenytoin

It is a prodrug of phenytoin, which is converted to phenytoin by phosphatases. It is used in status epilepticus. It is available for i.m. and i.v. administration. It is *less* cardiotoxic when compared to phenytoin. Fosphenytoin can be administered in normal saline or glucose. It can be administered at a faster rate than phenytoin. Cardiac monitoring is required during intravenous administration of fosphenytoin.

■ Carbamazepine (Iminostilbene)

Carbamazepine is chemically related to tricyclic antidepressants (TCAs).

Mechanism of action

Like phenytoin, carbamazepine slows the rate of recovery of Na⁺ channels from inactivation, thereby reduces the neuronal excitability.

Pharmacokinetics

Carbamazepine is absorbed slowly and erratically from the GI tract, binds to plasma proteins; well distributed in the body including the cerebrospinal fluid (CSF) and metabolized in liver. Repeated use causes enzyme induction and reduces the effectiveness of the drug itself (autoinduction) as well as that of valproate, phenytoin, lamotrigine, topiramate, oral contraceptive (OC) pills, etc.

Adverse effects

The common adverse effects of carbamazepine include sedation, drowsiness, vertigo, ataxia, diplopia, blurred vision, nausea, vomiting and confusion. Hypersensitivity reactions are skin rashes, eosinophilia, lymphadenopathy and hepatitis. Rarely, it causes bone marrow depression with neutropenia, aplastic anaemia and agranulocytosis. On chronic therapy, it may cause water retention due to the release of antidiuretic hormone (ADH).

Uses

1. Carbamazepine is one of the most commonly used antiepileptic drug. It is the drug of choice in GTCS and partial (SPS and CPS) seizures.
2. Carbamazepine is the drug of choice in the treatment of trigeminal and other neuralgias; it is also useful in other neuropathic disorders. The other drugs useful are phenytoin, gabapentin, TCAs (amitriptyline), etc.
Other treatment options are surgical division, cryosurgery, injection of alcohol or phenol in close proximity to nerve or ganglia.
3. Carbamazepine is used in the treatment of acute mania and bipolar disorder (see p. 196).

■ Oxcarbazepine (Iminostilbene)

Oxcarbazepine is an analogue of carbamazepine. Mechanism of action and therapeutic uses are similar to carbamazepine. It is a prodrug and is converted to active form after administration. Its

enzyme-inducing property is much *less*; hence drug interactions are very few. It is *less* potent and *less* toxic than carbamazepine.

■ Phenobarbitone (Barbiturate)

Phenobarbitone is a barbiturate and was widely used as an antiepileptic drug. Its use has declined because of availability of safer drugs. It acts by potentiating GABA (see mechanism of action of barbiturate on p. 146). Phenobarbitone is absorbed slowly but completely after oral administration; about 50% is bound to plasma proteins. Repeated administration causes enzyme induction and reduces the effectiveness of co-administered drugs.

Adverse effects

The most common side effect of phenobarbitone is sedation, but tolerance develops gradually with continued administration. The other side effects are nystagmus, ataxia, confusion, megaloblastic anaemia and skin rashes. On chronic therapy, it may cause behavioural disturbances with impairment of memory in children.

Uses

Phenobarbitone is effective in GTCS and partial seizures. It is the cheapest antiepileptic drug. It is also useful in the prophylactic treatment of febrile convulsions. In status epilepticus, phenobarbitone is injected intravenously when the convulsions are not controlled with diazepam and phenytoin.

■ Ethosuximide (Succinimide)

It is effective for the treatment of absence seizures. It acts by inhibiting T-type Ca^{2+} currents in thalamic neurons. It is completely absorbed after oral administration. The common side effects are GI disturbances like nausea, vomiting and anorexia. The other side effects are headache, hiccough, eosinophilia, neutropenia, thrombocytopenia with bone marrow depression and rarely skin rashes.

■ Valproic Acid (Sodium Valproate): Carboxylic Acid Derivative

Sodium valproate is a broad-spectrum antiepileptic drug.

Mechanism of action

1. Like phenytoin and carbamazepine, valproate delays the recovery of Na^+ channels from inactivation.
2. Like ethosuximide, it blocks T-type Ca^{2+} current in thalamic neurons.
3. Increases the activity of GABA in the brain by:
 - a. Increased synthesis of GABA by stimulating GAD (glutamic acid decarboxylase) enzyme.
 - b. Decreased degradation of GABA by inhibiting GABA-transaminase (GABA-T) enzyme.

Pharmacokinetics

Valproate is rapidly and almost completely absorbed from the GI tract, highly (about 90%) bound to plasma proteins, metabolized in liver and excreted in urine.

Adverse effects (Note the mnemonic: VALPROATE)

1. The common side effects related to GI tract are nausea, Vomiting, Anorexia and abdominal discomfort.

2. CNS side effects include sedation, ataxia and Tremor.
3. An Elevation in liver enzymes may occur. A rare but serious complication is fulminant hepatitis (Liver), hence, avoided in children below 3 years of age. Monitoring of hepatic function is essential during valproate therapy.
4. Teratogenicity: Orofacial and digital abnormalities; neural tube defects with increased incidence of spina bifida, so it should not be given during pregnancy.
5. The other adverse effects include skin Rashes, Alopecia and curling of hair; acute Pancreatitis may occur rarely.

Uses

Sodium valproate is highly effective in absence, myoclonic, partial (SPS and CPS) and generalized tonic-clonic seizures. Other uses of valproate include mania and bipolar disorder.

■ Diazepam, Lorazepam, Clonazepam (Benzodiazepines)

Diazepam and lorazepam are effective in controlling status epilepticus. Clonazepam, a long-acting benzodiazepine, is used in absence and myoclonic seizures. Intravenous diazepam is used in the emergency treatment of status epilepticus, tetanus, eclamptic convulsions, febrile convulsions, drug-induced convulsions, etc. Diazepam has a rapid onset but short duration of action; hence repeated doses are required. Diazepam can be administered rectally in children during emergency. Lorazepam has a rapid onset and long duration of action, hence preferred in status epilepticus.

For **Mechanism of action** see p. 143.

Adverse effects

Intravenous diazepam and lorazepam may cause hypotension and respiratory depression. The main side effects of clonazepam are sedation and lethargy, but tolerance develops on chronic therapy. Other side effects are hypotonia, dysarthria, dizziness and behavioural disturbances like irritability, hyperactivity, lack of concentration, etc.

■ Gabapentin

It is an analogue of GABA. It freely crosses BBB and acts by releasing GABA. It is orally effective, not metabolized in the body and excreted unchanged in urine. There is no enzyme-inducing property, so drug interactions are rare. It is mainly used as an adjunct in partial (SPS and CPS) seizures. It is also useful in migraine prophylaxis, diabetic neuropathy, bipolar disorder and postherpetic neuralgias. The common side effects are sedation, ataxia, fatigue, headache and tremor.

■ Pregabalin

The mechanism of action is similar to gabapentin. It is useful in partial seizures and neuralgias. Sedation is a common side effect.

■ Lamotrigine

Lamotrigine has a broad spectrum of antiepileptic activity. Like phenytoin and carbamazepine, lamotrigine delays the recovery of Na⁺ channels from inactivation. It is well absorbed after oral administration and

metabolized in liver. It is useful in GTCS, absence, myoclonic and partial (SPS and CPS) seizures. The adverse effects are sedation, ataxia, headache, nausea, vomiting and skin rashes.

■ Topiramate

It has a broad spectrum of antiepileptic activity. Like phenytoin, topiramate delays the recovery of Na⁺ channels from inactivation. It also increases GABA and decreases glutamate activities. It is effective orally in GTCS, myoclonic and partial (SPS and CPS) seizures. Adverse effects are sedation, fatigue, weight loss, nervousness and confusion. It reduces the effectiveness of oral contraceptives.

■ Status Epilepticus

It is a medical emergency and should be treated immediately. It is characterized by recurrent attacks of tonic–clonic seizures without the recovery of consciousness in between or a single episode lasts longer than 30 minutes.

Treatment

1. Hospitalize the patient.
2. Maintain airway and establish a proper i.v. line.
3. Administer oxygen.
4. Collect blood for estimation of glucose, calcium, electrolytes and urea.
5. Maintain fluid and electrolyte balance.

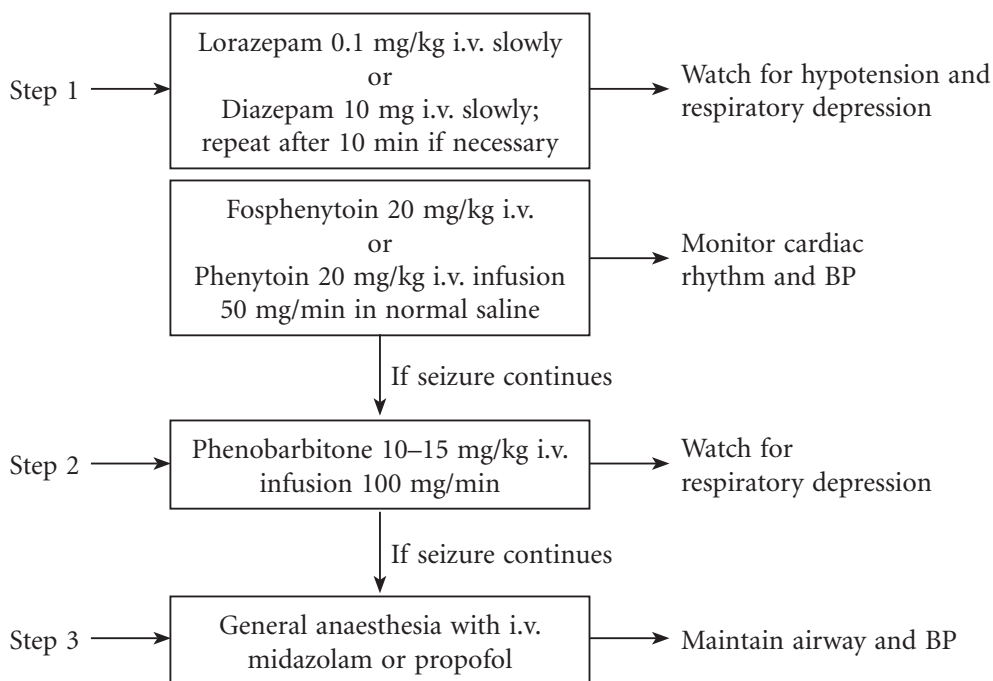

Dose and interactions of antiepileptic drugs are summarised in Table 6.10.

Table 6.10 Doses and Drug Interactions of Antiepileptics

Drug	Dose	Interactions
Phenytoin	200–400 mg	<ol style="list-style-type: none"> 1. <i>Phenytoin</i> × <i>OC pills, steroids, vitamin D, theophylline, etc.</i> Phenytoin induces microsomal enzymes and enhances the breakdown of OC pills, vitamin D, steroids, etc. and reduces the effectiveness of co-administered drug 2. <i>Phenytoin</i> × <i>carbamazepine</i> Mutual induction of metabolism and reduced plasma concentration of both the drugs 3. <i>Chloramphenicol</i> <i>INH</i> <i>Warfarin</i> } × <i>Phenytoin</i> These drugs inhibit the metabolism of phenytoin → plasma concentration of phenytoin increases → phenytoin toxicity may occur
Carbamazepine	600–1200 mg	<ol style="list-style-type: none"> 1. <i>Carbamazepine</i> × <i>phenytoin, phenobarbitone, sodium valproate, OC pills</i> Carbamazepine induces the metabolism of these drugs and reduces their effects 2. <i>INH</i> <i>Erythromycin</i> } × <i>Carbamazepine</i> These drugs inhibit carbamazepine metabolism; carbamazepine toxicity may occur
Phenobarbitone	100–200 mg	<i>Phenobarbitone</i> × <i>OC pills, warfarin, griseofulvin, theophylline</i> Phenobarbitone induces the metabolism of these drugs and reduces their effects
Ethosuximide	500–1500 mg	<i>Ethosuximide</i> × <i>valproate</i> Valproate inhibits the metabolism and increases plasma concentration of ethosuximide
Sodium valproate	1500–2000 mg	—

Key Points for Dentists

- ➔ Intravenous diazepam should be given slowly.
- ➔ Phenytoin should be infused in normal saline as it precipitates in dextrose solution.
- ➔ Antiepileptic drugs should not be discontinued suddenly as seizures may be precipitated.
- ➔ Folic acid should be given to women on antiepileptics to prevent neural tube defects.
- ➔ Patients on antiepileptic drugs should consult the physician before taking other drugs due to the possibility of drug interactions.
- ➔ Ketamine, large doses of lignocaine, metronidazole, fluoroquinolones, tramadol, enflurane, etc. are contraindicated in epileptics as they decrease seizure threshold.

ANALGESICS

Analgesics are drugs that relieve pain without significantly altering consciousness. They relieve pain without affecting its cause.

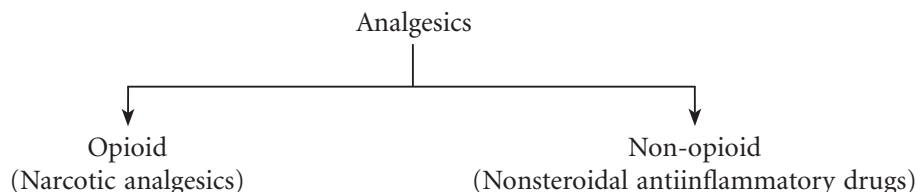

OPIOID ANALGESICS

Morphine is the most important alkaloid of opium—the dried juice obtained from the capsules of *Papaver somniferum*. Opium contains many other alkaloids, e.g. codeine, thebaine, papaverine, etc. The term ‘opiates’ refers to drugs derived from opium poppy, whereas ‘opioid analgesic’ applies to any substance (endogenous peptides or drugs) that produces morphine-like analgesia.

Classification of opioids

1. **Opioid agonists**
 - a. *Natural opium alkaloids*: Morphine, codeine, thebaine*, papaverine*, noscapine*.
 - b. *Semisynthetic opiates*: Heroin, pholcodine*, hydromorphone, oxycodone.
 - c. *Synthetic opioids*: Pethidine, tramadol, methadone, dextropropoxyphene, fentanyl, alfentanil, sufentanil, remifentanil.
2. **Opioid agonist–antagonists**: Pentazocine, butorphanol.
3. **Partial μ -receptor agonist**: Buprenorphine.

Opioid Receptor

The three main types of opioid receptors are μ (mu), κ (kappa) and δ (delta). These receptor-mediated effects are given below.

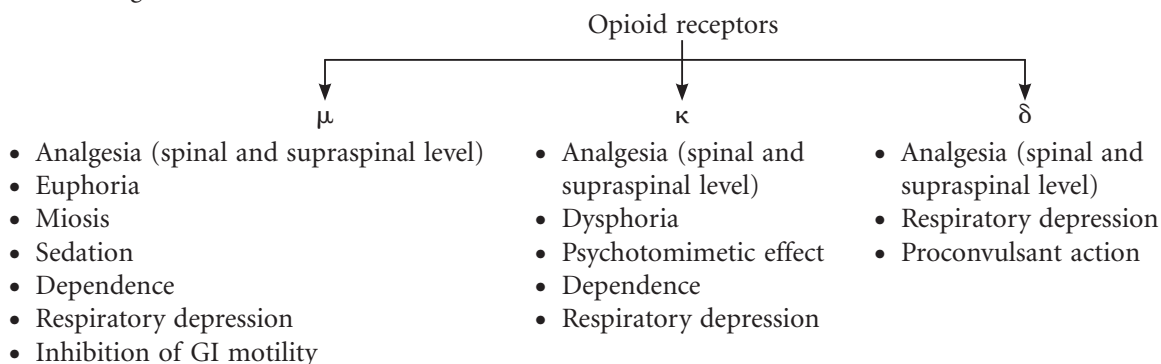

Opioid Agonists

Mechanism of action

Morphine and other opioids produce their actions by interacting with various opioid receptors—mu (μ), delta (δ) and kappa (κ). They are located at spinal and supraspinal levels (medulla, midbrain, limbic system and cortical areas) and peripheral nerves. Morphine is the prototype drug.

* Have no analgesic activity.

Pharmacological actions of morphine

Morphine has mainly CNS depressant effects; it also stimulates certain sites in the CNS.

1. CNS

a. *The depressant effects are:*

- i. Analgesic effect: Mediated mainly through μ -receptors at spinal and supraspinal sites, it is the most important action of morphine. It is a very potent and efficacious analgesic. It causes sedation, drowsiness, euphoria, makes the person calm and raises the pain threshold. Perception of pain and reaction to it (fear, anxiety and apprehension) are altered by these drugs. Moderate doses of morphine relieve dull and continuous pain, whereas sharp, severe intermittent pain such as traumatic or visceral pain requires larger doses of morphine.

MORPHINE CVS*

Miosis
Analgesia
Respiratory depression
Physical and psychological dependence
Histamine release, hypotension, hypothermia
Itching
Nausea and vomiting
Euphoria
Cough suppression, constipation
Vagal stimulation (bradycardia)
Sedation and hypnosis

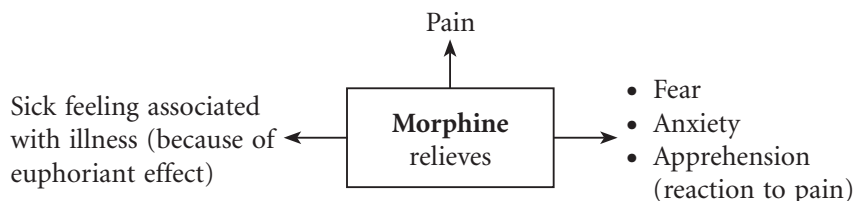

Therefore, morphine relieves 'total pain'.

- ii. *Euphoria (feeling of well-being)*: It is an important component of analgesic effect. Anxiety, fear, apprehension associated with painful illness or injury are reduced by opioids.
 - iii. *Sedation*: Morphine, in therapeutic doses, causes drowsiness and decreases the physical activity.
 - iv. *Respiratory depression*: It depresses respiration by a direct effect on the respiratory centre in the medulla; both rate and depth are reduced because it reduces sensitivity of the respiratory centre to CO_2 . Respiratory depression is the commonest cause of death in acute opioid poisoning.
 - v. *Cough suppression*: It has a direct action on cough centre in the medulla.
 - vi. *Hypothermia*: In high doses, morphine depresses temperature-regulating centre and produces hypothermia.
- ##### b. *The stimulant effects are:*
- i. *Miosis*: Morphine produces constriction of the pupils due to stimulation of III cranial nerve nucleus. Some tolerance develops to this action. Pinpoint pupils are an important feature in acute morphine poisoning. Miosis is not seen on topical application of morphine to the eye.
 - ii. *Nausea and vomiting*: It is due to direct stimulation of the chemoreceptor trigger zone (CTZ) in the medulla. 5-HT₃ antagonists are the drugs of choice to control opioid-induced nausea and vomiting. H₁-blockers, such as cyclizine or prochlorperazine may also be used.
 - iii. *Vagal centre*: It stimulates vagal centre in the medulla and can cause bradycardia.

*Mnemonic for actions of morphine: 'MORPHINE CVS'.

c. Other effects

- i. *Physical and psychological dependence*: Repeated use of opioids causes physical and psychological dependence.
 - ii. *Histamine release*: Morphine is a histamine liberator and causes skin rashes, urticaria, vasodilatation, bronchoconstriction, etc.
 - iii. Itching can occur due to histamine release.
2. **CVS**: Morphine produces vasodilatation and fall of BP.

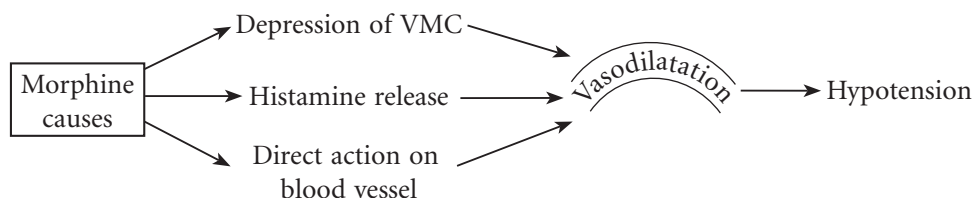

It mainly causes vasodilatation of peripheral vessels, which results in shift of blood from pulmonary to systemic vessels leading to relief of pulmonary oedema associated with acute left ventricular failure.

3. **GIT**: It causes constipation by direct action on the GIT; the CNS action decreases GI motility and increases the tone of the sphincters.
4. **Urinary bladder**: It may cause urinary retention by increasing the tone of urethral sphincter.
5. **Biliary tract**: It increases intrabiliary pressure by increasing the tone of sphincter of Oddi.
6. **Bronchi**: It can cause bronchospasm by releasing histamine from the mast cells.

Pharmacokinetics

On oral administration, morphine is absorbed slowly and erratically. It also undergoes extensive first-pass metabolism; hence oral bioavailability of morphine is poor. Morphine is commonly administered by i.v., i.m. or s.c. routes. It can also be administered by oral, epidural or intrathecal routes. It is widely distributed in the body, crosses placental barrier and is metabolized in liver by glucuronide conjugation. Morphine-6-glucuronide has more potent analgesic action than morphine and is excreted in urine.

Adverse effects

1. Nausea, vomiting and constipation.
2. Respiratory depression.
3. Hypotension due to vasodilatation.
4. Drowsiness, confusion and mental clouding.
5. Itching (due to histamine release) and skin rashes.
6. Difficulty in micturition.
7. Respiratory depression in newborn due to administration of morphine to the mother during labour.
8. Drug tolerance develops to most of the effects of morphine (some tolerance develops to miotic and constipating effects). There is cross-tolerance among the opioids.
9. Drug dependence (physical and psychological dependence) is the main drawback of opioid therapy. Psychological dependence is associated with intense craving for the drug. Physical dependence is associated with the development of withdrawal symptoms (abstinence syndrome) when administration of an opioid is stopped abruptly. The symptoms and signs are irritability, body shakes, jumping and other symptoms like yawning, lacrimation, sweating, fever, diarrhoea,

palpitation, insomnia, rise in BP, loss of weight, etc. (the symptoms are just opposite to morphine actions). Dependence is mediated through μ -receptors.

Treatment of morphine dependence

- a. Hospitalization of the patient.
- b. Gradual withdrawal of morphine.
- c. Substitution therapy with methadone. Opioid agonist like methadone is preferred because:
 - i. It is orally effective.
 - ii. It has longer duration of action.
 - iii. Withdrawal symptoms are mild.

One milligram of methadone will substitute 4 mg of morphine. Later, methadone is gradually reduced and completely stopped within 10 days. Buprenorphine can also be used for treatment of opioid dependence.

- d. Pure opioid antagonist like naltrexone is used after detoxification to produce opioid blockade to prevent relapse in patients who have a sincere desire to leave the habit. It is the preferred antagonist because it is orally effective and has a long duration of action.
 - e. Psychotherapy, occupational therapy, community treatment and rehabilitation.
10. Acute morphine poisoning: The characteristic triad of symptoms are respiratory depression, pinpoint pupils and coma. The other signs and symptoms are cyanosis, hypotension, shock and convulsions. Death is usually due to respiratory depression.

Treatment of acute morphine poisoning

- a. Hospitalization.
- b. Maintain airway, breathing and circulation.
- c. Ventilatory support (positive pressure respiration).
- d. Gastric lavage with potassium permanganate.
- e. Specific antidote: Naloxone 0.4–0.8 mg intravenously, dose is repeated till respiration becomes normal.

Naloxone is a pure antagonist, competitively blocks opioid receptors and rapidly reverses respiratory depression (Fig. 6.10). The duration of action of naloxone is shorter; hence repeated administration is needed.

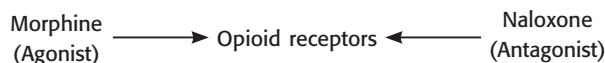

Fig. 6.10 Competitive antagonism.

Note: Administration of naloxone to morphine addicts should be done with caution because it may precipitate severe withdrawal symptoms.

Contraindications

1. **Head injury:** Morphine is contraindicated in cases with head injury because:
 - a. Vomiting, miosis and mental clouding produced by morphine interferes with assessment of progress in head-injury patients.
 - (b) Morphine \rightarrow Respiratory depression \rightarrow CO_2 retention \rightarrow Cerebral vasodilation \rightarrow $\uparrow\uparrow$ Intracranial tension.
2. **Bronchial asthma:** Morphine may precipitate an attack by histamine release.
3. **Chronic obstructive pulmonary disease (COPD):** It should be avoided in patients with low respiratory reserve—emphysema, chronic bronchitis, cor pulmonale, etc.
4. **Hypotensive states:** It should be used cautiously in shock or when there is reduced blood volume.

5. **Hypothyroidism and hypopituitarism:** There is a prolonged and exaggerated response to morphine.
6. **Infants and elderly:** They are more prone to respiratory depressant effect of morphine. In elderly male, there are increased chances of urinary retention.
7. **Undiagnosed acute abdominal pain:** Morphine, if given before diagnosis, interferes with diagnosis by masking the pain. Its spasmogenic effect may aggravate the pain (biliary colic).

Codeine: Natural Opium Alkaloid

1. Codeine has analgesic and cough-suppressant effects; is administered orally.
2. Compared to morphine:
 - a. It is less potent as an analgesic.
 - b. It has less respiratory depressant effect.
 - c. It is less constipating.
 - d. It has low addiction liability.
3. It has selective cough suppressant effect (antitussive); hence it is used to suppress dry cough.
4. It potentiates analgesic effect of aspirin and paracetamol.

Codeine is used for relief of moderate pain. The main **side effects** are constipation and sedation.

Pethidine (Meperidine) (Table 6.11)

Pethidine can be administered by oral, i.v., s.c. and i.m. routes. It is well absorbed from the GI tract, but bioavailability is about 50% because of first-pass metabolism; widely distributed in the body, crosses placental barrier and metabolized in liver. The metabolites are excreted in urine.

Table 6.11 Comparative Features of Morphine and Pethidine

Morphine	Pethidine (Meperidine)
Natural opium alkaloid	Synthetic opioid
Analgesic dose: 10 mg i.m., i.v. (morphine is 10 times more potent)	Analgesic dose: 100 mg i.m., i.v. (1/10 as potent as morphine)
It produces sedation, euphoria, respiratory depression and drug addiction	In equianalgesic doses, pethidine also produces same amount of sedation, euphoria, respiratory depression and drug addiction as morphine At times, pethidine can cause CNS stimulation with tremor, twitches and convulsions due to its metabolite, norpethidine
Effects on smooth muscles: 1. Constipation + 2. Biliary spasm + 3. Urinary retention + 4. Miosis +	Effect on smooth muscles: 1. Spasmodic effects—constipation, biliary spasm, urinary retention, etc. are less prominent 2. Miosis is less prominent
Has antitussive effect	Has no significant antitussive effect
Releases histamine	It causes less histamine release
It has a rapid onset and longer duration of action (6–8 h)	It has a rapid onset but shorter duration of action (3–4 h)
Morphine causes severe respiratory depression in the newborn, when it is given to mother during labour	Pethidine causes less respiratory depression in newborn

Adverse effects

The adverse effects are similar to those of morphine. It can cause tremors, hallucinations, muscle twitches and rarely convulsions due to its metabolite, norpethidine. Tolerance, physical and psychological dependence can also develop with pethidine.

Diphenoxylate: It is a pethidine congener and is used in the treatment of diarrhoea. It is available in combination with atropine. It is rarely used at present because of its dangerous side effect—paralytic ileus.

Loperamide: Loperamide is a pethidine congener. It reduces GI motility and secretions but increases the tone of the anal sphincter. It is used in the symptomatic treatment of diarrhoea. Common side effects are constipation and abdominal cramps.

Therapeutic Uses of Morphine and its Congeners

1. **As analgesic** (Table 6.12 and Figure 6.11): Morphine and other opioids are very potent and efficacious analgesics; hence they are used for moderate-to-severe painful conditions, such as acute myocardial infarction (MI), burns, pulmonary embolism, fracture of mandible and long bones, bullet wound, etc. Opioids are also used to control severe pain in terminal stages of cancer. In renal and biliary colic, atropine is used with morphine to counteract the spasmogenic effect of morphine. Opioids are the preferred analgesics in severe painful conditions.

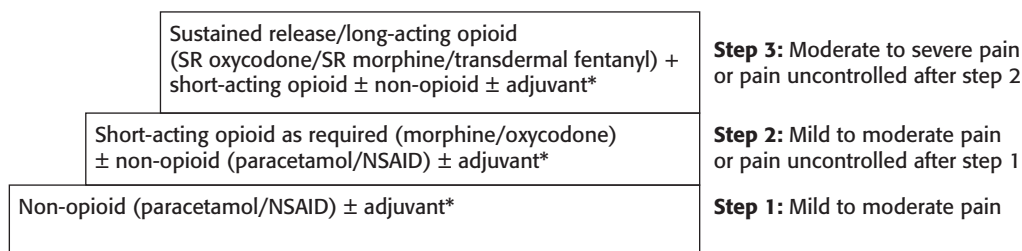

Fig. 6.11 World Health Organization analgesic ladder: *Adjuvants, e.g. carbamazepine, amitriptyline, diazepam, prednisolone, etc.

Patient-controlled analgesia: This allows the patient to control the delivery of s.c., epidural or i.v. analgesic in a safe and effective way through a pump. The patient should inform the nurse when he takes a dose so that it can be replaced.

2. **Preanaesthetic medication:** Opioids like morphine and pethidine are used about half-an-hour before anaesthesia because of their sedative, analgesic and euphoric effects; the dose of anaesthetic required is reduced.
3. **Acute pulmonary oedema (cardiac asthma):** Intravenous morphine relieves breathlessness associated with acute left ventricular failure due to pulmonary oedema by:
 - a. Reducing preload on heart by peripheral vasodilatation.
 - b. Shifting the blood from pulmonary to systemic circulation.
 - c. Reducing anxiety, fear and apprehension associated with the illness.
4. **Postanaesthetic shivering:** Pethidine is effective.
5. **Cough:** Codeine, pholcodine, dextromethorphan, etc. are commonly used for suppression of dry cough.
6. **Diarrhoea:** Synthetic opioids such as diphenoxylate and loperamide are used for symptomatic treatment of diarrhoea.

Other Opioids

The route of administration, uses and some important features are represented in Table 6.12.

Table 6.12 Route of Administration, Uses and Some Important Points of Opioids

Opioid	Route of Administration	Uses	Other Points
Tramadol	Oral, i.v.	<ul style="list-style-type: none"> In mild-moderate pain due to trauma and surgery In labour pain and cancer pain 	<ul style="list-style-type: none"> Should be avoided in epileptics (it decreases seizure threshold) In patients on MAO inhibitors (may precipitate hypertensive crisis)
Fentanyl	Intravenous, epidural, intrathecal, transdermal patch	<ul style="list-style-type: none"> Used as analgesic to supplement anaesthetics (i.v.) In chronic pain and cancer pain (transdermal patch) Postoperative pain 	<ul style="list-style-type: none"> Rapid acting and potent analgesic Minimal histamine release; Slight decrease in HR and BP
Fentanyl analogues <ul style="list-style-type: none"> Alfentanil Sufentanil Remifentanil 	Intravenously	<ul style="list-style-type: none"> As analgesics—perioperatively 	<ul style="list-style-type: none"> Shorter acting than fentanyl More potent as analgesics than morphine
Methadone	Oral, i.m.	<ul style="list-style-type: none"> As substitution therapy in opioid-dependent subjects (see p. 180) For chronic pain 	–
Dextropropoxyphene	Oral	Used with paracetamol in moderate pain	<ul style="list-style-type: none"> Poor antitussive effect Analgesic effect is similar to codeine
Pentazocine	Oral, i.m., s.c.	Traumatic and postoperative pain	<ul style="list-style-type: none"> Acts on κ receptors → Dysphoria, hallucinations, nightmares (psychotomimetic effect)—can be reversed by naloxone Causes sympathetic stimulation → tachycardia, palpitation, ↑BP (contraindicated in patients with hypertension and ischaemic heart disease)
Butorphanol	i.v., i.m.	As an analgesic in postoperative pain	<ul style="list-style-type: none"> Pharmacological actions and adverse effects are similar to pentazocine Causes cardiac stimulation and psychotomimetic effects
Buprenorphine	i.m., i.v., sublingual	<ul style="list-style-type: none"> As an analgesic in postoperative pain, MI, cancer pain and preanaesthetic medication As substitution therapy in opioid dependent subjects 	<ul style="list-style-type: none"> Respiratory depression induced by buprenorphine cannot be reversed completely with naloxone; hence not used in labour pain Has long half-life

Tramadol

It is a synthetic codeine derivative with weak agonistic activity at μ -receptors. It also inhibits the reuptake of noradrenaline and 5-HT.

**Pharmacological actions**

Tramadol causes:

1. Analgesia.
2. Respiratory depression.
3. Physical and psychological dependence.
4. Nausea and vomiting.
5. Euphoria.
6. Constipation.
7. Sedation.

} Less than with equianalgesic doses of morphine

Fentanyl

It is a synthetic opioid with a potent μ -agonistic effect (100 times more potent than morphine as an analgesic).

Pharmacological actions are similar to morphine. Alfentanil, sufentanil and remifentanil are short-acting fentanyl analogues. They are useful for short procedures where intense analgesia is required.

Methadone

It is a synthetic opioid with agonistic effect at μ -receptors; has a long duration of action.

Pharmacological actions are similar to morphine.



1. Miosis
2. Analgesia
3. Respiratory depression
4. Physical and psychological dependence
5. Nausea and vomiting
6. Euphoria
7. Cough suppression, constipation
8. Sedation

} Similar to morphine, but has less addiction liability

Dextropropoxyphene

It is structurally similar to methadone. The side effects are nausea, constipation, sedation, abdominal pain, etc.

*Line with downward arrow indicates that effect is less than morphine. The size of the arrows indicates degree of effect (smaller the size, lesser the effect).

■ Opioid Agonist–Antagonists and Partial Agonists

▶ Pentazocine

Pentazocine is an opioid agonist–antagonist. It has agonistic action at κ - and weak antagonistic action at μ -receptors.

Pharmacological actions: In low doses, its pharmacological actions are almost similar to that of morphine.



1. Analgesia (due to κ action)
 2. Respiratory depression
 3. Physical and psychological dependence
 4. Nausea and vomiting
 5. Constipation
 6. Biliary spasm
- } less than morphine

Adverse effects are sedation, nausea, vomiting, respiratory depression, hallucinations and nightmares. Tachycardia, palpitation and rise in BP are seen with high doses.

▶ Buprenorphine

It is a partial μ -receptor agonist and is about 25 times more potent than morphine as analgesic.

Pharmacological actions: They are qualitatively similar to morphine but has a delayed onset and prolonged duration of action.



1. Miosis.
2. Analgesia (more potent than morphine).
3. Respiratory depression.
4. Physical and psychological dependence (less).
5. Hypotension.
6. Nausea and vomiting.
7. Euphoria.
8. Constipation (less).
9. Sedation.

■ Opioid Antagonists: Naloxone, Naltrexone and Nalmefene (See p. 180—Fig. 6.10)

They are pure opioid antagonists. These drugs have no agonistic activity.

*Line with downward arrow indicates effect is less than morphine. '↓' under alphabet indicates action is similar to morphine. Size of the arrow indicates degree of effect—smaller the size, lesser the effect.

Upward arrow above the alphabet indicates higher potency than morphine.

Naloxone, naltrexone and nalmefene competitively reverse the effects of both natural and synthetic opioids, but they do not completely reverse buprenorphine induced respiratory depression. Naloxone also blocks analgesic effect of placebo and acupuncture, and effects of endogenous opioid peptides. Naloxone is orally not effective because of high first-pass metabolism. It is short acting. On i.v. administration, it immediately antagonizes all actions, especially respiratory depression of morphine and other opioids. Intravenous naloxone precipitates withdrawal symptoms in morphine and heroin addicts.

Uses of naloxone

1. Main therapeutic use of naloxone is for the treatment of morphine and other opioid poisoning (see p. 180).
2. In the treatment of opioid overdose, intravenous naloxone rapidly reverses the respiratory depression induced by opioids (except buprenorphine where it causes partial reversal of respiratory depression).
3. To treat neonatal asphyxia due to use of opioids in the mother during labour.

Uses of naltrexone

Naltrexone is orally effective and has longer duration of action.

1. Naltrexone is used for opioid-blockade therapy to prevent relapse in opioid-dependent individuals.
2. It is also used for the treatment of alcoholism, as it reduces the urge to drink.

Nalmefene

- It is administered intravenously.
- It is long acting.
- Useful in the treatment of opioid overdose.

■ Endogenous Opioid Peptides

Endorphins, enkephalins and dynorphins are naturally occurring substances present in the brain and other body tissues. They are called endogenous opiates because they resemble opium alkaloids (e.g. morphine) in their actions. These peptides appear to be involved in placebo and acupuncture-induced analgesia.

Key Points for Dentists

- Morphine can cause vomiting.
- Chronic use of opioids causes dependence.
- Morphine is contraindicated in elderly and patients with head injury.
- Pentazocine is contraindicated in patients with ischaemic heart disease and hypertension.
- Patients receiving opioid analgesics for more than 1 or 2 days should be given a laxative.
- Oral or rectal route is preferred in children if they have to receive opioid analgesics for many days to avoid pain of injection.

PSYCHOPHARMACOLOGY

The major types of psychiatric illnesses are—psychoses and neuroses (Table 6.13).

Table 6.13 Differences Between Psychoses and Neuroses

Psychoses	Neuroses
Major mental illness	Minor mental illness
Insight into the illness is lost	Insight is present
Judgement is lost (capacity to discriminate between right and wrong, good and bad)	Judgement is not lost
Disturbance of mental function (thinking, emotion, etc.)	Rare
Disturbance of thought: Present, e.g. schizophrenia	Disturbance of thought: Rare, e.g. anxiety neurosis, phobic states (abnormal fear), obsessive compulsive disorder, hysterical attacks, reactive depression, etc.

■ Antipsychotic Drugs

Antipsychotic drugs are also known as neuroleptic drugs or antischizophrenic drugs. Neuroleptic drugs are mainly used in schizophrenia, acute mania and other acute psychotic states.

Classification

1. **Phenothiazines:** Chlorpromazine, triflupromazine, trifluoperazine, thioridazine, fluphenazine.
2. **Thioxanthenes:** Thiothixene.
3. **Butyrophenones:** Haloperidol.
4. **Atypical antipsychotics:** Clozapine, risperidone, olanzapine, aripiprazole, ziprasidone, quetiapine.
5. **Others:** Loxapine, pimozide.

Mechanism of action of antipsychotics

- **Conventional antipsychotics** → Mainly block dopamine (D₂) receptors in the limbic system and mesocortical areas.
- **Atypical antipsychotics** → Block 5-HT_{2A} receptors in mesolimbic system.

■ Chlorpromazine (Phenothiazines)

Chlorpromazine is the prototype drug.

Pharmacological actions of chlorpromazine (Fig. 6.12)

- **Central nervous system:** In patients with schizophrenia, chlorpromazine:
 - a. Reduces agitation and aggressiveness.
 - b. Reduces spontaneous movements.
 - c. Suppresses hallucinations and delusions.
 - d. Relieves anxiety.
 - e. Corrects disturbed thought and behaviour.
 - f. Does not affect intelligence but impairs vigilance.
- **Endocrine**
Prolactin secretion is under the control of prolactin-releasing factor (PRF) and prolactin-inhibitory factor (PIF). PIF itself is dopamine; hence the blockade of DA-receptors in pituitary may cause increased production of prolactin leading to galactorrhoea, amenorrhoea and infertility in females; gynaecomastia in males.

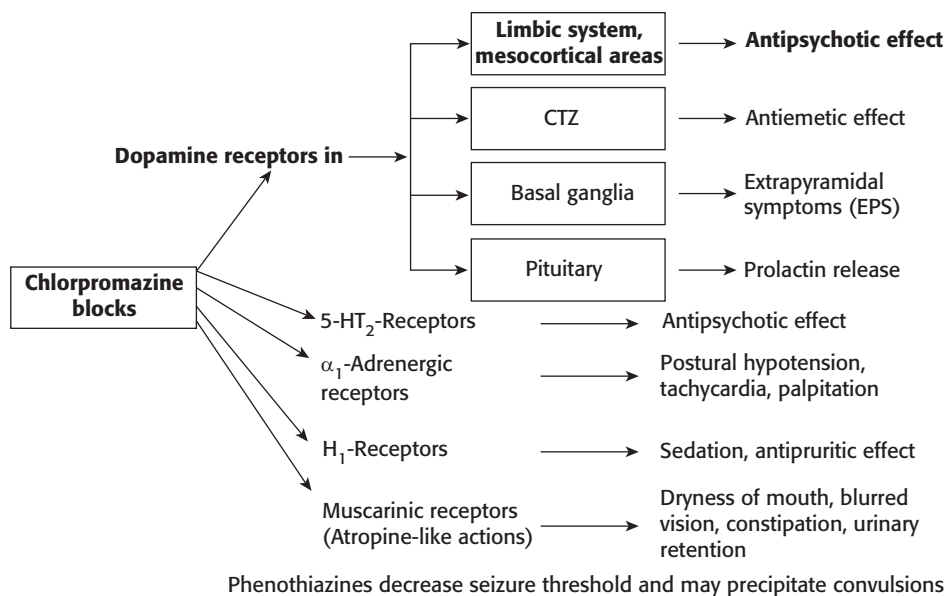

Fig. 6.12 Mechanism of action, pharmacological actions and adverse effects of chlorpromazine. CTZ, chemoreceptor trigger zone.

- Tolerance to sedative, and hypotensive actions develop within a few weeks.
- Other actions (Fig. 6.12).

Pharmacokinetics

Phenothiazines are effective orally and parenterally. Chlorpromazine is highly bound to plasma proteins—reaches high concentration in the brain. It is metabolized in liver and excreted in urine.

Adverse effects of antipsychotics

Important side effects of these drugs are extrapyramidal symptoms (EPS).

1. **Parkinsonism:** They are tremor, rigidity, hypokinesia, etc. Centrally acting anticholinergics (benzhexol, benzotropine and antihistamines like promethazine, diphenhydramine, etc.) are effective in controlling these symptoms.
2. **Acute dystonias:** Uncontrolled muscular movements involving the face, tongue, neck, etc.
3. **Akathisia:** Feeling of restlessness—the person cannot sit at a place and has a desire to move about.
4. **Neuroleptic malignant syndrome:** It is a rare but serious complication characterized by muscular rigidity, hyperpyrexia, mental confusion and coma. It is treated with i.v. dantrolene. The above effects are reversible on stoppage of therapy.
5. **Tardive dyskinesia** (*Tardive*—late occurring): It is characterized by involuntary movements of the mouth, tongue and the upper limbs. It develops in about 20% of patients after months or years of antipsychotic treatment. Treatment is usually unsuccessful.
6. Muscarinic, α₁-adrenergic and H₁-receptor-blocking side effects (Fig. 6.12).
7. Weight gain is common with clozapine and olanzapine.
8. Endocrine side effects are due to increased prolactin level resulting in amenorrhoea, galactorrhoea and infertility in females; gynaecomastia in males.

9. Hypersensitivity reactions can occur—skin rashes, itching, dermatitis, leucopaenia and rarely obstructive jaundice. Agranulocytosis is a serious adverse effect with clozapine.

Haloperidol

- Widely used antipsychotic drug
- Causes severe extrapyramidal symptoms
- Has less seizure potential
- Does not cause weight gain
- Preferred agent for acute schizophrenia

Atypical Antipsychotics

These drugs exert antipsychotic effect mainly by 5-HT₂ blockade. They have weak D₂-blocking effects—low risk of extrapyramidal symptoms. Pharmacological actions and adverse effects of atypical antipsychotics—clozapine, olanzapine, risperidone, aripiprazole, ziprasidone are given in Table 6.14.

Table 6.14 Comparative Features of Antipsychotic Drugs

Drug	Sedative Effect	EPS	Hypotensive Effect	Other Effects
Chlorpromazine	+++	++	++	Anticholinergic effects, hypersensitivity reactions (skin rashes, obstructive jaundice), weight gain, hyperprolactinaemia, seizures
Thioridazine	+++	+	+++	Prominent anticholinergic action
Haloperidol	+	+++	+	Jaundice rare
Clozapine	+++	–	+++	Atypical antipsychotic; EPS are rare; agranulocytosis, seizures, sedation, salivation, weight gain, hyperglycaemia
Risperidone	++	++	+++	Weight gain, EPS at high doses, postural hypotension
Olanzapine	+	+	++	Marked anticholinergic effect, weight gain, seizures, precipitation of diabetes and rarely EPS
Aripiprazole	±	–	±	Partial agonist at D ₂ . Less weight gain and hyperglycaemia; longer duration of action
Ziprasidone	+	+	+	Weight gain is minimal

Therapeutic uses

1. **Schizophrenia:** The neuroleptics are the only efficacious drugs available for the treatment of schizophrenia. The atypical antipsychotics are commonly prescribed owing to the lower risk of EPS. Risperidone and olanzapine are frequently used. Clozapine is reserved for resistant cases of schizophrenia. Of the older agents, high-potency drugs like haloperidol are used.
2. **Mania:** Acute mania can be treated with a neuroleptic (chlorpromazine or haloperidol); lithium is used for maintenance therapy. Atypical antipsychotics can be used for acute mania. Lithium is not preferred in acute mania because of its slow onset of action and narrow margin of safety.
3. **As antiemetic:** These drugs (phenothiazines, haloperidol, etc.) produce antiemetic effect by blocking D₂-receptors in CTZ. However, they are not routinely used as antiemetics because of their side

effects. Phenothiazine, such as prochlorperazine, is used to prevent and treat nausea and vomiting associated with migraine or drug-induced emesis due to morphine, anticancer drugs, etc.

4. **Intractable hiccough** has been treated with chlorpromazine.

Key Points for Dentists

- Dryness of mouth is a common side effect of most of the antipsychotics; hence increased chances of orodental infections.
- Monitor blood pressure for postural hypotension. Patient on antipsychotics should be advised to take care while getting up from dental chair.

ANTI-ANXIETY AGENTS

1. **Benzodiazepines:** Benzodiazepines are the preferred anxiolytic drugs. Chlordiazepoxide, diazepam, lorazepam, oxazepam, alprazolam, etc. are used as anxiolytic agents. They facilitate the inhibitory effect of GABA. They act on limbic system. They are mainly useful for short-term treatment of anxiety. Adverse effects are sedation, impairment of memory, confusion and dependence. Tolerance develops to anxiolytic effect on long-term use.
2. **Buspirone:** Buspirone is a partial agonist of 5-HT_{1A}-receptor and causes selective anxiolytic effect. It has no sedative, anticonvulsant or muscle-relaxant effects. It does not potentiate the central effects of alcohol or other CNS depressants. There is no tolerance or drug dependence. It does not affect GABA transmission. It is mainly used in the treatment of generalized anxiety states. But its effect is delayed and may take 2 weeks to fully develop. So, it is not effective for acute cases.
3. **β-Blockers:** Propranolol and other nonselective β-blockers are used mainly to reduce symptoms of anxiety, such as tachycardia, palpitation, tremor, sweating, etc.
4. **Selective serotonin reuptake inhibitors (SSRIs) and serotonin and noradrenaline reuptake inhibitor (venlafaxine):** They are the preferred agents for most of the anxiety disorders except acute anxiety. Response is delayed.

ANTIDEPRESSANTS

Depression is a very common clinical condition associated with feeling of sadness, loss of interest, self-neglect, anorexia, sleep disturbances, suicidal feelings in severe cases, etc.

Classification

1. **Tricyclic antidepressants (Mnemonic: ANTI-DEP)**

Amitriptyline, Amoxapine	Doxepin
Nortriptyline	E -----
Trimipramine	Protriptyline
Imipramine	
2. **Selective serotonin (5-HT) reuptake inhibitors (SSRIs)**
Fluoxetine, fluvoxamine, citalopram, escitalopram, sertraline, paroxetine.
3. **Atypical antidepressants**
Trazodone, bupropion, mianserin, duloxetine, mirtazapine, venlafaxine.
4. **MAO-A inhibitors**
Moclobemide, clorgyline.

■ Tricyclic Antidepressants

Pharmacokinetics

TCAs are well absorbed through the GI tract and are highly bound to plasma proteins. They are widely distributed in tissues including CNS. They are metabolized in liver. Some of them (imipramine, amitriptyline, etc.) produce active metabolites, which are responsible for the long duration of action of these drugs. These drugs are excreted mainly in urine as inactive metabolites.

Adverse effects and contraindications of tricyclic antidepressants (Fig. 6.13)

1. 'Atropine-like' side effects: Dryness of mouth, blurring of vision, constipation, urinary retention, etc.
2. α_1 -adrenergic blocking effects: Postural hypotension, tachycardia, cardiac arrhythmias, etc.
3. H_1 -blocking effects: Sedation and confusion.
4. Other effects: Increased appetite, weight gain; convulsions may be precipitated (seizure threshold is lowered).

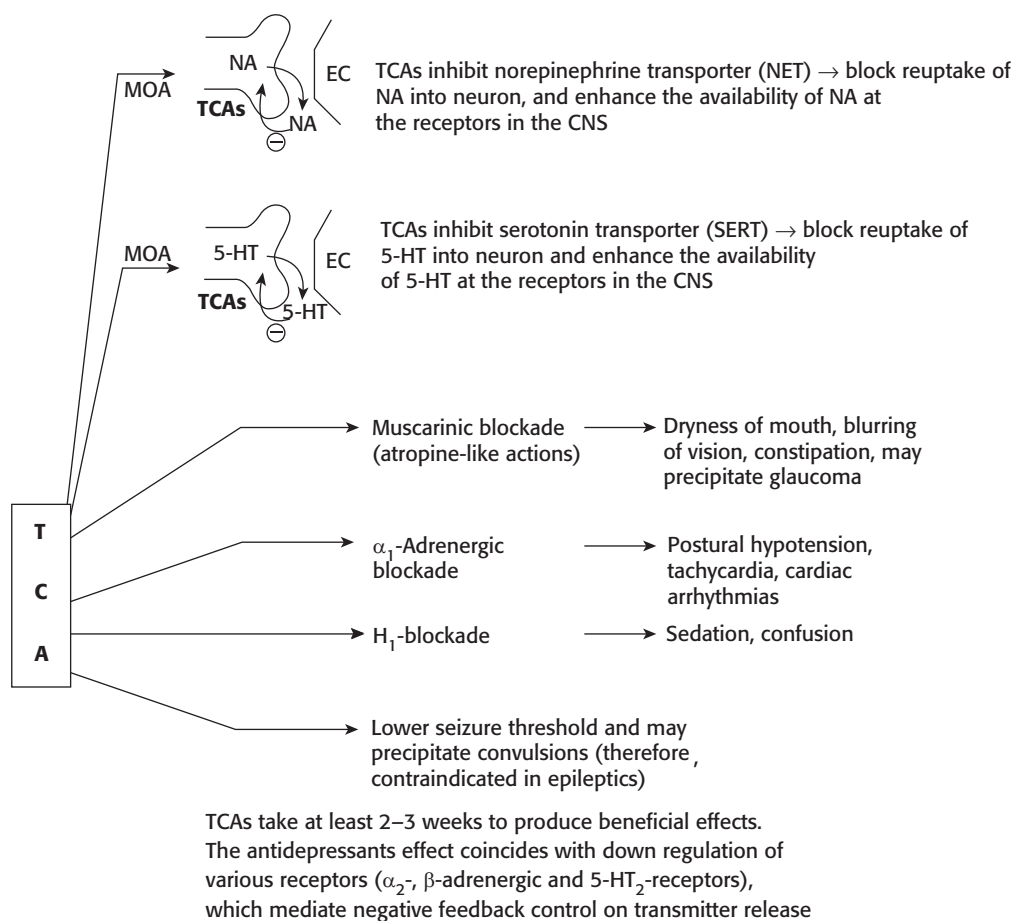

Fig. 6.13 Mechanism of action, pharmacological actions and adverse effects of tricyclic antidepressants (TCAs). MOA, mechanism of action; EC, effector cell; NA, noradrenaline; 5-HT, serotonin; CNS, central nervous system.

Tricyclic antidepressants are **contraindicated** in patients with glaucoma, epilepsy, ischaemic heart disease and enlarged prostate.

Other antidepressants are shown in Table 6.15.

Table 6.15 Comparative Features of Antidepressants

Drug	MOA	Other Points
1. Tricyclic antidepressants	See above	See above
2. Selective serotonin reuptake inhibitors (SSRIs) <ul style="list-style-type: none"> • Fluoxetine • Fluvoxamine • Citalopram • Escitalopram • Paroxetine • Sertraline 	Increase the availability of 5-HT at receptors in the CNS and enhance serotonergic activity <ul style="list-style-type: none"> • No anticholinergic effects • No hypotension • No sedation • No weight gain • Do not precipitate convulsions • Do not cause cardiac arrhythmias • Orally effective • <i>Side Effects:</i> GI symptoms like nausea, vomiting and diarrhoea, headache, insomnia, sexual dysfunction, impotence, loss of libido. SSRIs inhibit drug-metabolizing enzymes and cause interactions with other drugs 	
3. Atypical antidepressants <ul style="list-style-type: none"> • Venlafaxine • Duloxetine } (SNRIs)	Inhibit the reuptake of serotonin and noradrenaline into the neuron	<ul style="list-style-type: none"> • No anticholinergic effects • No sedation • No weight gain • Do not precipitate convulsions • Orally effective • <i>Side Effects:</i> Nausea, sweating, sexual dysfunction, anxiety, hypertension
• Bupropion	Inhibits the reuptake of DA and NA into the neuron	<ul style="list-style-type: none"> • Useful for smoking cessation • No anticholinergic effects • No hypotension • No sedation • May precipitate seizures • <i>Side Effects:</i> Dry mouth, tremor, sweating, convulsions
• Mirtazapine	Increases NA and 5-HT release	<ul style="list-style-type: none"> • Mirtazapine [Noradrenergic and Specific Serotonergic Antidepressant (NaSSA)] • <i>Side Effects:</i> Sedation, weight gain
• Trazodone	Blocks 5-HT reuptake and 5-HT ₂ -antagonist; blocks α_1 -adrenergic receptors	<ul style="list-style-type: none"> • <i>Side Effects:</i> Sedation • Hypotension • Priapism (painful erection of penis)
• Mianserin	Increases NA releases by blocking presynaptic α_2 -receptors	<ul style="list-style-type: none"> • Has antianxiety action • Can precipitate seizures • Anticholinergic and cardiac side effects may occur rarely • Causes sedation

MAO Inhibitors

Monoamine oxidase (MAO) is a mitochondrial enzyme involved in the metabolism of biogenic amines. There are two isoforms of MAO. MAO-A is responsible mainly for the metabolism of NA, 5-HT and tyramine. MAO-B is more selective for dopamine metabolism.

Moclobemide

A selective and reversible inhibitor of MAO-A (RIMA) is relatively free of food and drug interactions. Hence, cheese reaction is rare. It is also devoid of anticholinergic, α_1 -adrenergic blocking and sedative effects.

Drug interactions

a. Involving TCAs

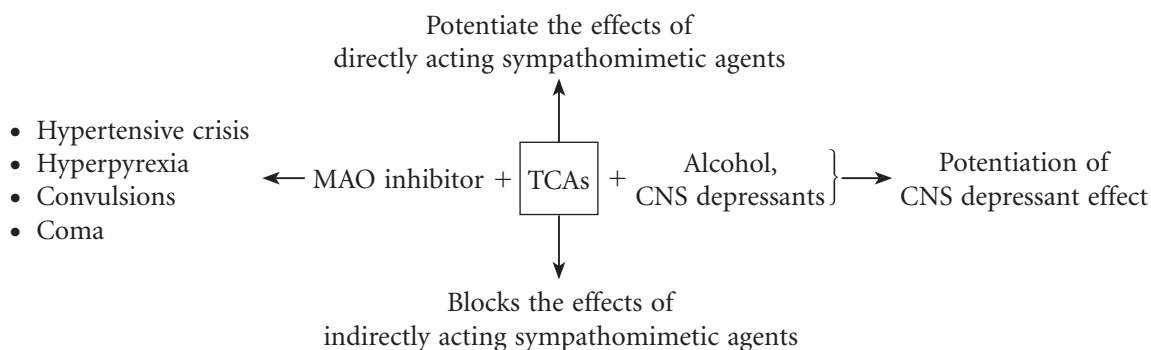

b. Serotonin syndrome

Concomitant administration of SSRIs with MAO inhibitors produces severe undesirable effects like tremor, restlessness, muscle rigidity, hyperthermia, sweating, shivering, seizures and coma due to increased serotonin levels at the synapses, which is termed as serotonin syndrome.

- c. SSRIs inhibit metabolism of a number of drugs such as TCAs, antipsychotics, β -blockers, phenytoin, carbamazepine, etc. and increase their plasma levels.

Cheese reaction

Normally, tyramine in food is metabolized by MAO in gut and liver. So, very little tyramine reaches systemic circulation. When a patient on MAOIs consumes food stuff rich in tyramine, it may result in fatal hypertensive crisis and cerebrovascular accidents. The preferred agent to treat this reaction is i.v. phentolamine (Fig. 6.14).

Uses of Antidepressants

1. **Depression:** Antidepressants are used in the treatment of endogenous depression (major depression) and during the phase of depression in bipolar illness. SSRIs are preferred over TCAs because of:
 - a. Better tolerability.
 - b. Less side effects (do not cause hypotension and sedation; do not have anticholinergic effects; no precipitation of convulsions; do not cause cardiac arrhythmias).
 - c. Longer duration of action.

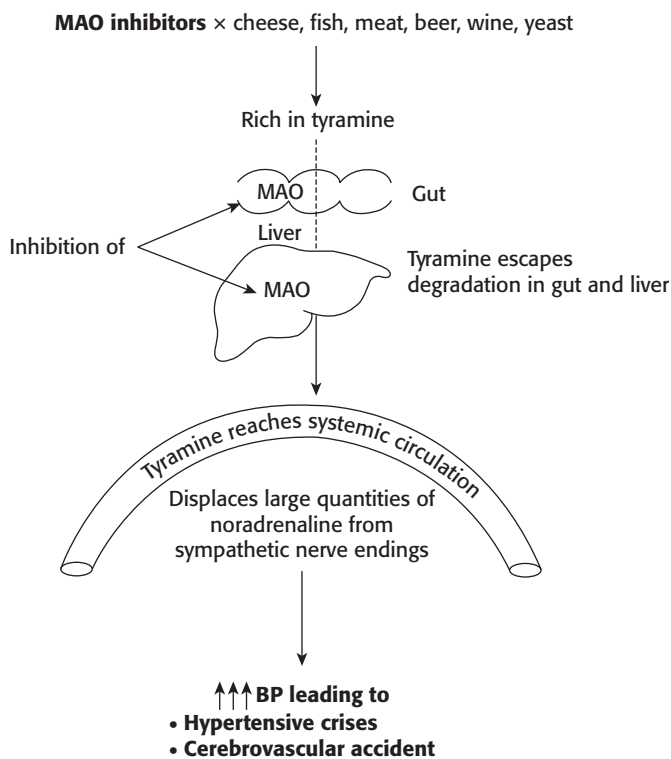

Fig. 6.14 Cheese reaction. MAO, monoamine oxidase; BP, blood pressure.

2. **Panic disorders**
3. **Obsessive compulsive disorders (OCD):** Clomipramine and fluvoxamine are highly effective.
4. **Nocturnal enuresis:** Imipramine is effective.
5. **Prophylaxis of migraine:** Amitriptyline is effective.
6. **Chronic pain including neuralgias:** TCAs are effective in trigeminal, herpetic, post-herpetic neuralgias, etc.

Key Points for Dentists

- ↳ Tricyclic antidepressants can cause dryness of mouth.
- ↳ Most of the antidepressants take 2–3 weeks to produce a clinical response.

DRUGS FOR BIPOLAR DISORDER

Bipolar disorder (manic-depressive illness) is a psychiatric disorder in which depression alternates with mania. Mania is an affective disorder that manifests as elation, agitation, hyperactivity, uncontrolled thought and speech.

Drugs used in bipolar disorder are lithium, carbamazepine, sodium valproate, olanzapine, risperidone, haloperidol, etc.

Lithium

Lithium was the first drug used for the treatment of mania. Recently, antiepileptic drugs such as carbamazepine, sodium valproate and gabapentin have been approved for the treatment of MDP.

Actions and mechanism

Lithium reduces motor activity, decreases euphoria, relieves insomnia and stabilizes the mood.

In the **neuronal membrane**:

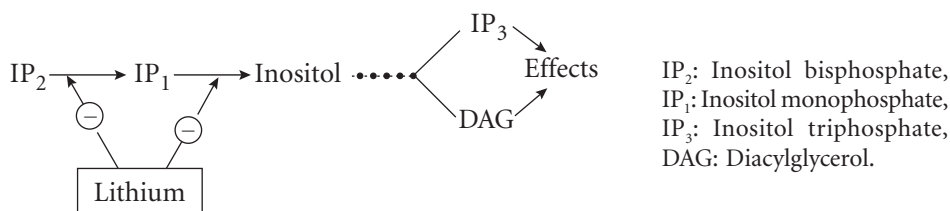

1. Lithium, by inhibiting the above steps, reduces the release of IP₃ and DAG, which are second messengers for both α -adrenergic and muscarinic transmission.
2. Lithium is a monovalent cation that can mimic the role of Na⁺.
3. Lithium also decreases the release of NA and DA in the brain.

Pharmacokinetics

Lithium carbonate is effective orally, does not bind to plasma proteins and is distributed throughout the total body water. It is not metabolized and gets excreted in urine, saliva, sweat, etc. Lithium is a monovalent cation. The kidney handles lithium in the same way as Na⁺. About 80% of the filtered lithium is reabsorbed in the proximal tubules. Sodium depletion reduces the rate of excretion of lithium and thus increases its toxicity. Lithium has low therapeutic index; hence therapeutic drug monitoring (TDM) is essential for optimal therapy (normal 0.5–1.5 mEq/L). Estimation of salivary concentration can be used for noninvasive monitoring of lithium.

Adverse effects

1. **GIT**: Nausea, vomiting and diarrhoea.
2. **CNS**: Tremor, ataxia, drowsiness, headache, muscular weakness and slurred speech.
3. **Renal**: Polyuria, polydipsia due to inhibition of ADH action.
4. **Goitre** with hypothyroidism and weight gain.
5. **Acute lithium toxicity** manifests as confusion, convulsions, cardiac arrhythmias, coma and death.

Lithium should be stopped immediately; patient is treated with intravenous normal saline to restore Na⁺ levels, which in turn promotes the excretion of lithium.

Uses

It is used as a prophylactic agent for bipolar disorder. It decreases the frequency and severity of both manic and depressive attacks; hence it is called as mood stabilizer. Lithium has a slow onset of action, hence, not useful for acute mania. Lithium is also useful in the prophylaxis of unipolar depression.

Drug interactions

1. **Lithium × thiazides/furosemide**: Thiazides and furosemide cause hyponatraemia. As a result, there will be a compensatory increase in the reabsorption of Na⁺ in the PCT. Along with Na⁺, reabsorption of lithium is also increased leading to toxicity. Therefore, readjustment of lithium dosage must be made to compensate it.

2. Lithium prolongs the neuromuscular blockade induced by both depolarizing (succinylcholine) and nondepolarizing (pancuronium) neuromuscular blockers.
3. **Lithium × haloperidol:** Long-term lithium therapy may cause rigidity and potentiates the extrapyramidal symptoms of haloperidol.

■ Other Drugs Used in Mania and Bipolar Disorder

- **Sodium valproate:** It is the preferred drug for the treatment of acute mania because of its rapid action, wider therapeutic index and better tolerability than lithium. It is useful prophylactically for bipolar disorder.
- **Carbamazepine:** Carbamazepine, an antiepileptic drug, has mood-stabilizing effect and is used in the treatment of bipolar disorder. It may be used alone or in combination with lithium or valproate. It is used prophylactically in bipolar disorder.
- **Topiramate** can be used as an adjunct in bipolar disorder.
- **Atypical antipsychotics:** Olanzapine, risperidone, aripiprazole, quetiapine, etc. are preferred agents to control acute attack of mania.
- **Benzodiazepines** like lorazepam or clonazepam are used as adjuncts if patient is agitated.

Key Points for Dentists

- Lithium is a drug with narrow safety margin; hence it requires therapeutic drug monitoring.
- Diarrhoea, vomiting and diuretics like furosemide, thiazides can cause sodium depletion and can result in lithium toxicity.

Autacoids and Respiratory System

The word 'autacoids' comes from the Greek words—*autos* (self) and *akos* (medicinal agent or remedy). Autacoids are produced by cells and act locally. Hence, they are also called 'local hormones'. Various autacoids are histamine, serotonin (5-HT), prostaglandins (PGs), leukotrienes, angiotensin, kinins and platelet activating factor (PAF).

HISTAMINE AND ANTIHISTAMINES

Histamine

Histamine is a biogenic amine present in many animal and plant tissues. It is also present in venoms and stinging secretions. It is synthesized by decarboxylation of the amino acid, histidine. Histamine is mainly present in storage granules of mast cells in tissues like skin, lungs, liver, gastric mucosa, placenta, etc. It is one of the mediators involved in inflammatory and hypersensitivity reactions.

Mechanism of action and effects of histamine

Histamine exerts its effects by binding to histamine (H) receptors.

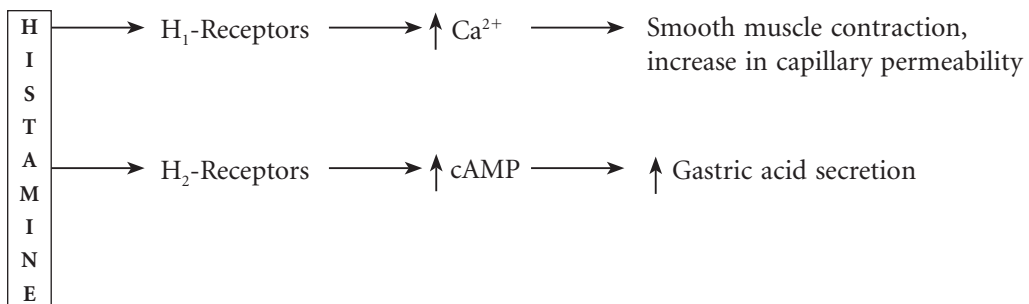

Histamine liberators

Many agents release histamine from mast cells (Fig. 7.1).

Uses

Histamine has no valid clinical use.

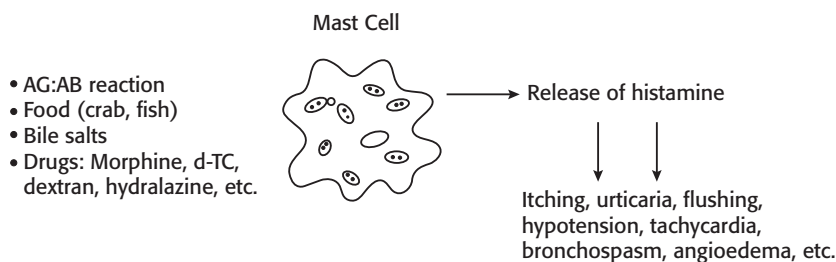

Fig. 7.1 Histamine liberators and its effects.

Betahistine

It is a histamine analogue that is used orally to treat vertigo in Meniere's disease. It probably acts by improving blood flow in the inner ear. The side effects are nausea, vomiting, headache and pruritus. It should be avoided in patients with asthma and peptic ulcer.

H₁-receptor Antagonists (H₁-blockers, Antihistamines)

Classification

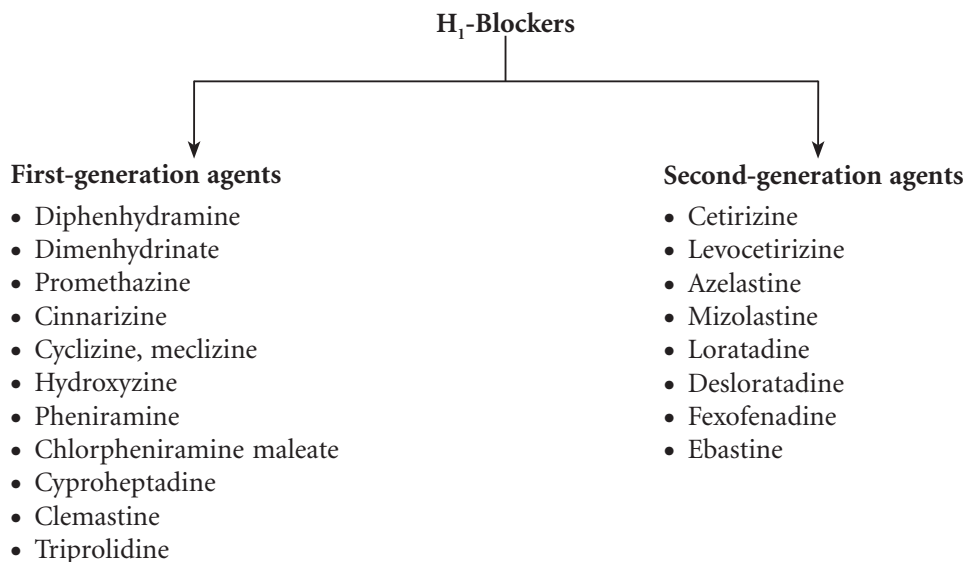

Mechanism of action of H₁-blockers

H₁-antihistamines antagonize the effects of histamine by competitively blocking H₁-receptors (competitive antagonism).



First-generation H₁-blockers

They are the conventional antihistamines.

Pharmacological actions

1. H₁-blockers cause central nervous system (CNS) depression—sedation and drowsiness. Certain antihistamines have antiemetic and antiparkinsonian effects.
2. They have antiallergic action, hence most of the manifestations of Type-I reactions are suppressed.
3. They have anticholinergic actions—dryness of mouth, blurring of vision, constipation, urinary retention, etc.

Pharmacokinetics

H₁-antihistamines are well absorbed after oral and parenteral administration. They are distributed widely throughout the body, metabolized extensively in liver and excreted in urine.

Adverse effects

1. The common adverse effects are sedation, drowsiness, lack of concentration, headache, fatigue, weakness, lassitude, incoordination, etc. Hence, H₁-antihistamines should be avoided while driving or operating machinery. These adverse effects are rare with second-generation antihistamines.
2. Gastrointestinal side effects are nausea, vomiting, loss of appetite and epigastric discomfort.
3. Anticholinergic side effects such as dryness of mouth, blurring of vision, constipation and urinary retention. These effects are not seen with second-generation antihistamines.
4. Teratogenic effects of some H₁-blockers have been observed in animals.
5. Allergic reactions may occur rarely with these agents, especially contact dermatitis on topical application.

Uses

1. **Allergic diseases:** H₁-antihistamines are used to prevent and treat symptoms of allergic reactions. For example, pruritus, urticaria, dermatitis, rhinitis, conjunctivitis and angioneurotic oedema respond to these drugs.
2. **Common cold:** They produce symptomatic relief by sedative and anticholinergic actions.
3. **Preanaesthetic medication:** Promethazine is used for its sedative and anticholinergic effects.
4. **As antiemetic:** Promethazine, diphenhydramine, dimenhydrinate, etc. are useful for prophylaxis of motion sickness because of their anticholinergic action. They act probably on the vestibular apparatus or cortex. Sedative effect also contributes to their beneficial effect. These drugs are useful in morning sickness, drug-induced and postoperative vomiting. Promethazine is used to control vomiting due to cancer chemotherapy and radiation therapy.

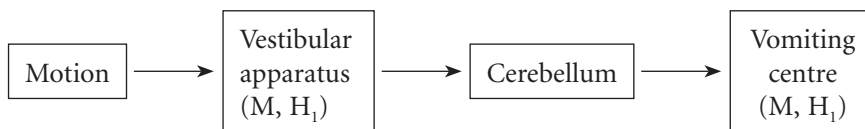

5. **Parkinsonism:** Imbalance between dopamine and acetylcholine (DA and ACh) in the basal ganglia produces parkinsonism. Promethazine, diphenhydramine or orphenadrine are used to control tremors, rigidity and sialorrhoea of parkinsonism due to their anticholinergic and sedative properties. Promethazine and diphenhydramine are also useful for the treatment of extrapyramidal side effects caused by phenothiazines or metoclopramide.

6. H₁-blockers are used to control mild **blood transfusion and saline infusion reactions** (chills and rigors) and as **adjunct in anaphylaxis**.
7. Cinnarizine, dimenhydrinate and meclizine are effective for controlling **vertigo** in Meniere's disease and in other types of vertigo.
8. **Sedative and hypnotic:** H₁-antihistamines (e.g. promethazine and diphenhydramine) are used to induce sleep, especially in children during minor surgical procedures.

Second-generation H₁-blockers (Table 7.1)

Cetirizine, loratadine, azelastine and fexofenadine are highly selective for H₁-receptors and have the following properties. They:

1. Have no anticholinergic effects.
2. Lack antiemetic effect.
3. Do not cross blood–brain barrier (BBB), hence cause minimal/no drowsiness.
4. Do not impair psychomotor performance.
5. Are relatively expensive.

Cetirizine is one of the commonly used second-generation antihistamine. In addition to H₁-blocking effect, it can also inhibit the release of histamine. It causes minimal/no drowsiness. It is not metabolized in the body. Incidence of cardiac arrhythmias is rare with this drug.

Uses

Second-generation H₁-blockers are used in various allergic disorders—rhinitis, dermatitis, conjunctivitis, urticaria, eczema, drug and food allergies.

Table 7.1 Second-generation H₁-antihistamines

Drug	Route and Duration of Action (hours)	Important Features
Cetirizine	PO, 12–24 h	Poorly crosses BBB; may cause drowsiness
Levocetirizine	PO, 12–24 h	More potent than cetirizine
Loratadine Desloratadine Mizolastine Ebastine	PO, 24 h	Non-sedating agents Cardiac arrhythmias have been noticed in animals treated with ebastine
Fexofenadine	PO, 12–24 h	Active metabolite of terfenadine Non-sedating Has no arrhythmogenic potential
Azelastine	Nasal spray, 12–24 h	Has a rapid onset and long duration of action

Key Points for Dentists

- First-generation antihistamines cause drowsiness; hence they should be avoided while driving, operating machinery, etc.
- Most of the second-generation antihistamines are non-sedative. They are ideal antihistamines for drivers and machine operators.

PROSTAGLANDINS AND LEUKOTRIENES (EICOSANOIDS)

■ Prostaglandins

Prostaglandins (PGs) are products of long-chain fatty acids. Arachidonic acid is the precursor for the biosynthesis of all PGs. The enzyme involved in the formation of PGs from arachidonic acid is cyclooxygenase (COX). The main PGs in humans are prostaglandin E₂ (PGE₂), prostaglandin F_{2α} (PGF_{2α}) and prostacyclin (PGI₂). Another class of substances obtained from arachidonic acid by the action of lipoxygenase is leukotrienes.

There are two forms of COX, COX-1 and COX-2 (Fig. 7.2). COX-1 is constitutive (it is always present) and is widely distributed. It participates in various physiological functions such as protection of gastric mucosa, homeostasis, regulation of cell division, etc. COX-2 is induced during inflammation by cytokines and endotoxins.

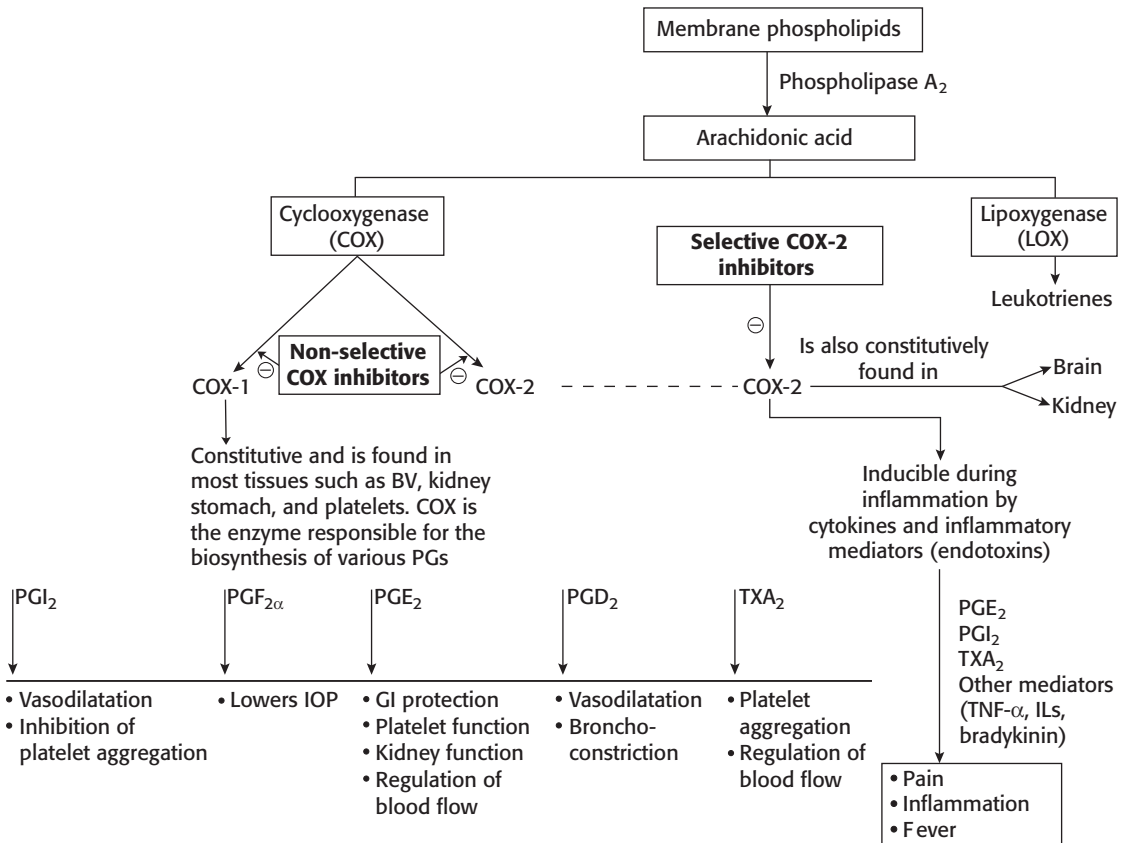

Fig. 7.2 The different roles of cyclooxygenases (COX-1 and COX-2) and drugs inhibiting them. BV, blood vessels.

Pharmacological actions and uses (Fig. 7.3, p. 203)

- Gastrointestinal (GI) tract:** PGE₂ and PGI₂ reduce acid secretion and increase the secretion of mucus in the stomach (cytoprotective action). Misoprostol (PGE₁ analogue) is used for the prevention of nonsteroidal antiinflammatory drug (NSAID)-induced ulcers (Table 7.2).
- Cardiovascular system:** PGD₂, PGE₂ and PGI₂ causes vasodilatation. PGF_{2α} constricts pulmonary veins and arteries. Thromboxane A₂ (TXA₂) is a vasoconstrictor.
 - PGE₁ (alprostadil) is used to maintain the patency of ductus arteriosus before surgery.
 - Prostacyclin (PGI₂) decreases peripheral, pulmonary and coronary resistance. PGI₂ (epoprostenol) is used to treat pulmonary hypertension.
- Platelets:** PGI₂ inhibits platelet aggregation. Hence, it is used during haemodialysis to prevent platelet aggregation.
- Eye:** PGF_{2α} has been found to decrease intraocular tension. Its analogue, e.g. latanoprost, bimatoprost, travoprost and unoprostone are used in glaucoma.
- Uterus:** PGE₂ (low concentration) and PGF_{2α} contract pregnant uterus. PGs are mainly used in mid-trimester abortion and missed abortion (see Table 7.2). Other uses include induction of labour, cervical priming and postpartum haemorrhage.
- Male reproductive system:** PGE₁ (alprostadil) is useful for the treatment of erectile dysfunction.

Table 7.2 Preparations and Uses of Prostaglandins

Preparations	Uses
Dinoprostone (PGE ₂)	Induction of labour Mid-term abortion Termination of pregnancy
Dinoprost (PGF _{2α})	Mid-term abortion
Carboprost (15-methyl PGF _{2α})	Mid-term abortion Control of postpartum haemorrhage (PPH)
Gemeprost (PGE ₁)	Cervical priming in early pregnancy
Alprostadil (PGE ₁)	Maintenance of patent ductus arteriosus in neonates with congenital heart disease Erectile dysfunction
Misoprostol (PGE ₁)	Peptic ulcer Abortion, PPH
Latanoprost (PGF _{2α})	Glaucoma

Adverse effects

They are nausea, vomiting, diarrhoea, fever, flushing, hypotension and backache (due to uterine contractions). Injections are painful due to sensitization of nerve endings (Fig. 7.3).

Key Point for Dentists

↳ Prostaglandins (PGs) should be avoided in pregnancy as they are uterine stimulants.

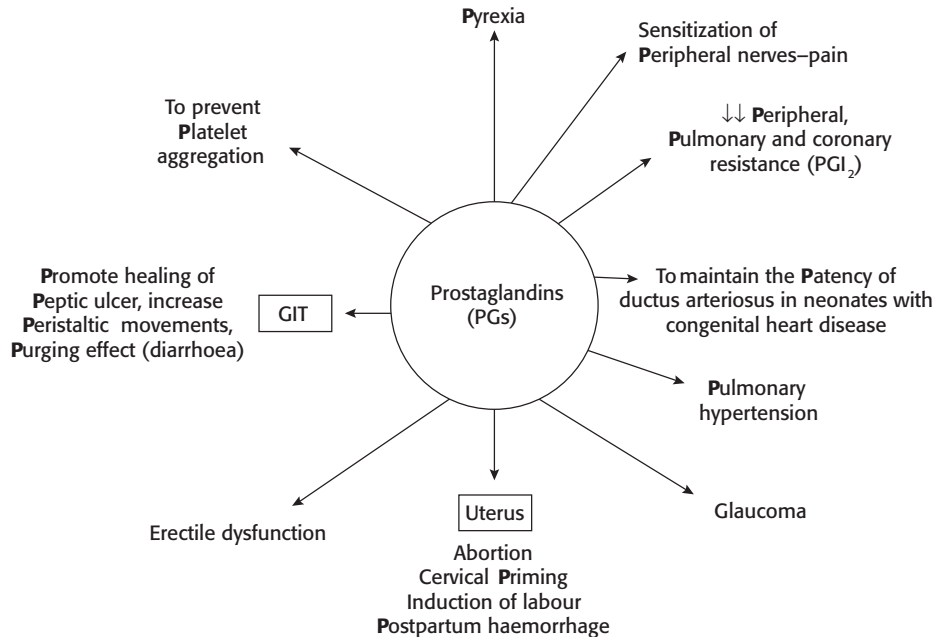

Fig. 7.3 Effects and uses of prostaglandins.

Leukotrienes

These are obtained from arachidonic acid by the action of lipoxygenase.

Leukotriene Antagonists

See p. 216.

NONSTEROIDAL ANTIINFLAMMATORY DRUGS

Classification

1. **Nonselective cyclooxygenase (COX) inhibitors**
 - a. **Salicylates:** Aspirin
 - b. **Propionic acid derivatives:** Ibuprofen, ketoprofen, naproxen, flurbiprofen.
 - c. **Acetic acid derivatives:** Diclofenac, aceclofenac.
 - d. **Fenamic acid derivatives:** Mefenamic acid.
 - e. **Pyrrolo-pyrrole derivatives:** Ketorolac, etodolac.
 - f. **Oxicam derivatives:** Piroxicam, tenoxicam.
 - g. **Indole derivatives:** Indomethacin.
2. **Preferential COX-2 inhibitors:** Nimesulide, meloxicam, nabumetone.
3. **Highly selective COX-2 inhibitors:** Etoricoxib, parecoxib, lumiracoxib.
4. **Analgesic—antipyretics with poor antiinflammatory effect:** Paracetamol, nefopam.

Mechanism of action

COX is the enzyme responsible for the biosynthesis of various prostaglandins. There are two well-recognized isoforms of COX: COX-1 and COX-2. COX-1 is constitutive, found in most tissues such as blood vessels, stomach and kidney. PGs have important role in many tissues (Fig. 7.2, p. 201). COX-2 is induced during inflammation by cytokines and endotoxins, and is responsible for the production of prostanoid mediators of inflammation.

Aspirin and most of the **nonsteroidal antiinflammatory drugs (NSAIDs)** inhibit both COX-1 and COX-2 isoforms, thereby decrease prostaglandin and thromboxane synthesis. The antiinflammatory effect of NSAIDs is mainly due to inhibition of COX-2. Aspirin causes irreversible inhibition of COX. Rest of the NSAIDs cause reversible inhibition of the enzyme.

Pharmacological actions of aspirin and other NSAIDs

Aspirin (acetylsalicylic acid) is the prototype drug. The other nonselective NSAIDs vary mainly in their potency, analgesic, antiinflammatory effects and duration of action.

1. **Analgesic effect:** NSAIDs are mainly used for relieving musculoskeletal pain, dysmenorrhoea and pain associated with inflammation or tissue damage. Analgesic effect is mainly due to peripheral inhibition of PG production.

They also increase pain threshold by acting at subcortical site. These drugs relieve pain without causing sedation, tolerance or drug dependence.

2. **Antipyretic effect:** The thermoregulatory centre is situated in the hypothalamus. Fever occurs when there is a disturbance in hypothalamic thermostat. NSAIDs reset the hypothalamic thermostat and reduce the elevated body temperature during fever. They promote heat loss by causing cutaneous vasodilatation and sweating. They do not affect normal body temperature. The antipyretic effect is mainly due to inhibition of PGs in the hypothalamus.

3. **Antiinflammatory effect:** Antiinflammatory effect is seen at high doses (aspirin: 4–6 g/day in divided doses). These drugs produce only symptomatic relief. They suppress signs and symptoms of inflammation such as pain, tenderness, swelling, vasodilatation and leukocyte infiltration but do not affect the progression of underlying disease.

The antiinflammatory action of NSAIDs is mainly due to inhibition of PG synthesis at the site of injury. They also affect other mediators of inflammation (bradykinin, histamine, serotonin, etc.), thus inhibit granulocyte adherence to the damaged vasculature. NSAIDs also cause modulation of T-cell function, stabilization of lysosomal membrane and inhibition of chemotaxis.

4. **Antiplatelet (antithrombotic) effect:** Aspirin in low doses (50–325 mg/day) irreversibly inhibits platelet TXA₂ synthesis and produces antiplatelet effect, which lasts for 8–10 days, i.e. the life-time of platelets. Aspirin in high doses (2–3 g/day) inhibits both PGI₂ and TXA₂ synthesis; hence beneficial effect of PGI₂ is lost. Aspirin should be withdrawn 1 week prior to elective surgery because of the risk of bleeding.

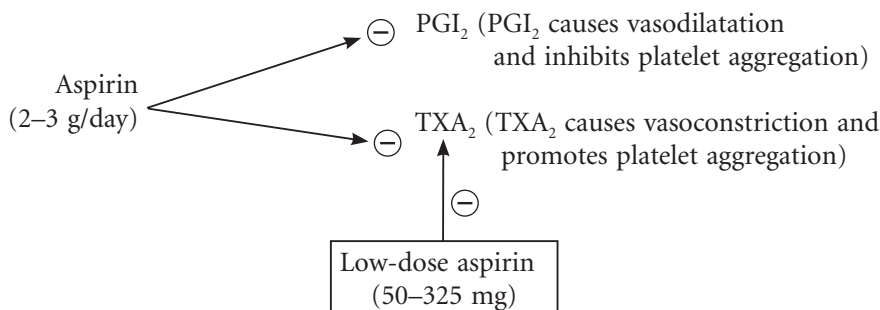

5. **Acid–base and electrolyte balance:** In therapeutic doses, salicylates cause respiratory alkalosis, which is compensated by excretion of alkaline urine (compensated respiratory alkalosis). In toxic doses, the respiratory centre is depressed and can lead to respiratory acidosis. Later, there is uncompensated metabolic acidosis.
6. **Gastrointestinal tract (GIT):** Aspirin irritates the gastric mucosa and produces nausea, vomiting and dyspepsia. The salicylic acid formed from aspirin also contributes to these effects. Aspirin also stimulates chemoreceptor trigger zone (CTZ) and produces vomiting (Fig. 7.4).

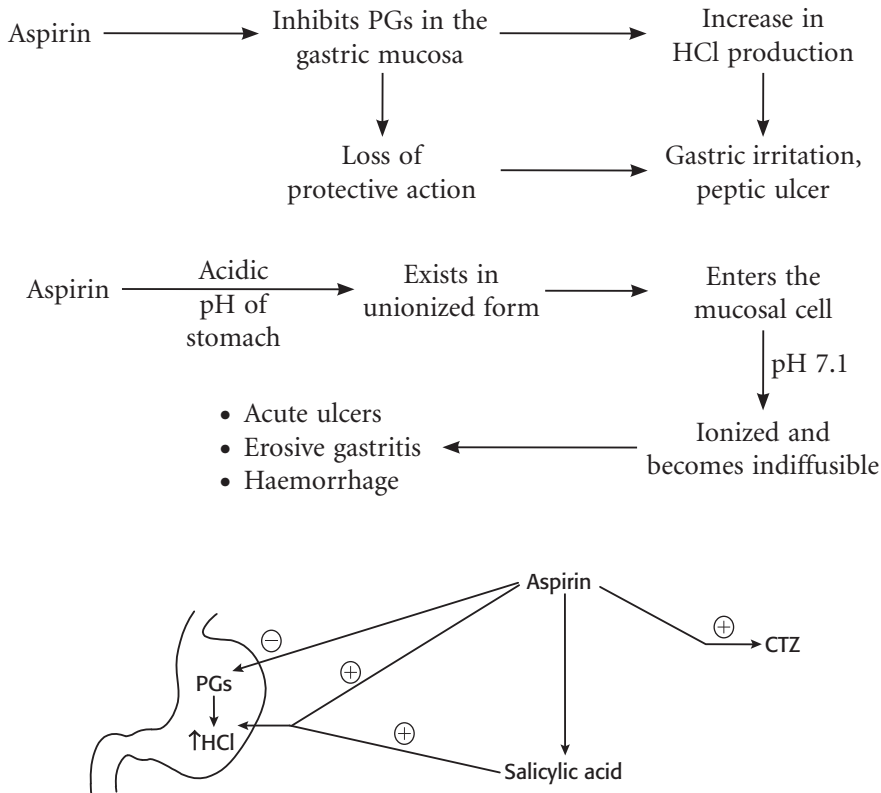

Fig. 7.4 Action of aspirin on stomach and CTZ. ⊕, Stimulation; ⊖, inhibition; PGs, prostaglandins.

7. **Cardiovascular system (CVS):** Prolonged use of aspirin and other NSAIDs causes sodium and water retention. They may precipitate congestive cardiac failure (CCF) in patients with low cardiac reserve. They may also decrease the effect of antihypertensive drugs.
8. **Urate excretion:** Salicylates, in therapeutic doses, inhibit urate secretion into the renal tubules and increase plasma urate levels. In high doses, salicylates inhibit the reabsorption of uric acid in renal tubules and produce uricosuric effect.

Pharmacokinetics

Salicylates are rapidly absorbed from the upper GI tract. They are highly bound to plasma proteins but the binding is saturable. Salicylates are well distributed throughout the tissues and body fluids; metabolized in liver by glycine and glucuronide conjugation. In low doses, elimination follows first-order kinetics and with high doses as the metabolizing enzymes get saturated, it switches over to zero-order

kinetics. After this, an increase in salicylate dosage increases its plasma concentration disproportionately and severe toxicity can occur. Alkalinization of urine increases the rate of excretion of salicylates.

Dosage regimen for aspirin

- *Analgesic dose:* 2–3 g/day in divided doses.
- *Antiinflammatory dose:* 4–6 g/day in divided doses.
- *Antiplatelet dose:* 50–325 mg/day (low-dose aspirin).

Adverse effects

1. **GIT:** Nausea, vomiting, dyspepsia, epigastric pain, acute gastritis, ulceration and GI bleeding. Ulcerogenic effect is the major drawback of NSAIDs, which is prevented/minimized by taking:
 - a. NSAIDs after food.
 - b. proton pump inhibitors/H₂-blockers/misoprostol with NSAIDs.
 - c. buffered aspirin (preparation of aspirin with antacid).
 - d. selective COX-2 inhibitors.
2. **Hypersensitivity:** It is relatively more common with aspirin. The manifestations are skin rashes, urticaria, rhinitis, bronchospasm, angioneurotic oedema and rarely anaphylactoid reaction. Bronchospasm (aspirin-induced asthma) is due to increased production of leukotrienes. Incidence of hypersensitivity is high in patients with asthma, nasal polyps, recurrent rhinitis or urticaria. Therefore, aspirin should be avoided in such patients.
3. In people with G6PD deficiency, administration of salicylates may cause haemolytic anaemia.
4. Prolonged use of salicylates interferes with action of vitamin K in the liver → decreased synthesis of clotting factors (hypoprothrombinaemia) → predisposes to bleeding (can be treated by administration of vitamin K).
5. **Reye's syndrome:** Use of salicylates in children with viral infection may cause hepatic damage with fatty infiltration and encephalopathy—Reye's syndrome. Hence, salicylates are contraindicated in children with viral infection.
6. **Pregnancy:** These drugs inhibit PG synthesis, thereby delay onset of labour and increase chances of postpartum haemorrhage. In the newborn, inhibition of PG synthesis results in premature closure of the ductus arteriosus.
7. **Analgesic nephropathy:** Slowly progressive renal failure may occur on chronic use of high doses of NSAIDs. Renal failure is usually reversible on stoppage of therapy but rarely, NSAIDs may cause irreversible renal damage.

■ Salicylism

Salicylate intoxication may be mild or severe. The mild form is called salicylism. The symptoms include headache, tinnitus, vertigo, confusion, nausea, vomiting, diarrhoea, sweating, hyperpnoea, electrolyte imbalance, etc. These symptoms are reversible on stoppage of therapy.

■ Acute Salicylate Poisoning

Manifestations are vomiting, dehydration, acid–base and electrolyte imbalance, hyperpnoea, restlessness, confusion, coma, convulsions, cardiovascular collapse, pulmonary oedema, hyperpyrexia and death.

Treatment

There is no specific antidote for salicylate poisoning. Treatment is symptomatic.

- Hospitalization.
- Gastric lavage followed by administration of activated charcoal (activated charcoal adsorbs the toxic material—physical antagonism).
- Maintain fluid and electrolyte balance. Correct acid–base disturbances.
- Intravenous sodium bicarbonate to treat metabolic acidosis. It also alkalinizes the urine and enhances renal excretion of salicylates (since salicylates exist in ionized form in alkaline pH).
- External cooling.
- Haemodialysis in severe cases.
- Vitamin K₁ and blood transfusion, if there is bleeding.

Clinical uses of NSAIDs

(For basis and explanation, see under pharmacological actions)

1. **As analgesic:** In painful conditions like toothache, headache, backache, bodyache, muscle pain, temporomandibular and other joint pain, bursitis, neuralgias, dysmenorrhoea, etc.
2. **As antipyretic:** To reduce elevated body temperature in fever paracetamol is preferred because:
 - a. Gastrointestinal symptoms are rare.
 - b. It does not cause Reye's syndrome in children.
3. **Rheumatoid arthritis:** NSAIDs are the first group of drugs to be used. They have analgesic and antiinflammatory effects and can produce only symptomatic relief, but they do not alter the progression of disease.
4. **Acute rheumatic fever:** Aspirin is the preferred drug. It reduces fever, relieves swelling and joint pain, but does not affect the normal course of the disease.
5. **Osteoarthritis:** In mild cases, paracetamol is used. In severe cases of osteoarthritis, other NSAIDs are more effective than paracetamol. Topical agents like methyl salicylate, diclofenac gel, capsaicin cream, etc. can also be used.
6. **Thromboembolic disorders:** The antiplatelet effect of low-dose aspirin is made use of in the prophylactic treatment of various thromboembolic disorders, such as:
 - a. Transient ischaemic attacks (TIA)
 - b. Myocardial infarction (MI)
 - (i) to reduce incidence of recurrent MI
 - (ii) to decrease mortality in post-MI patients
7. **Other uses:**
 - a. Medical closure of patent ductus arteriosus (indomethacin is preferred).
 - b. Colon and rectal cancer: Regular use of aspirin is reported to reduce the risk of cancer.
 - c. Aspirin is reported to reduce the risk and retard the onset of Alzheimer's disease.
 - d. To control radiation-induced diarrhoea.
 - e. To control pruritus and flushing associated with the use of nicotinic acid.

Aspirin *per se* is rarely used at present because of the following disadvantages

1. It has a short duration of action, requires large doses and frequent administration.
2. Gastric irritation and ulcerogenic effect are the main drawbacks of NSAIDs. The incidence is high with aspirin.
3. Salicylates should be avoided in children with viral infection.
4. NSAIDs may precipitate bronchospasm in patients with bronchial asthma (aspirin-induced asthma).

Other NSAIDs (Table 7.3)

They have similar mechanism of action, pharmacological actions, therapeutic uses and adverse effects. They vary mainly in their potency, duration of action, analgesic and antiinflammatory effects.

Table 7.3 NSAIDs and Their Important Features

Drug	Route and Formulations with Oral Dose	Other Points
1. Ibuprofen	Oral and topical gel Dose: 400–600 mg TDS	<ul style="list-style-type: none"> • It has moderate antiinflammatory effect • It is better-tolerated than aspirin • It can be used in children (does not cause Reye's syndrome)
2. Diclofenac	Oral, i.m., rectal, topical, gel and ophthalmic preparation (eye drops) Dose: 50 mg BD or 100 mg sustained-release preparation OD	<ul style="list-style-type: none"> • It has potent antiinflammatory effect • It gets concentrated in synovial fluid, hence preferred in inflammatory conditions of joint (arthritis) • Incidence of hepatotoxicity is more • Combination of diclofenac with misoprostol (PGE₁ analogue) available, which reduces GI irritation and peptic ulcer
3. Indomethacin Note: It has <ul style="list-style-type: none"> • extra mechanism • extra uses • extra side effects 	Oral, eyedrops and suppository Dose: 50 mg TDS	<ul style="list-style-type: none"> • It is a nonselective COX inhibitor • It has potent antiinflammatory effect • It inhibits migration of neutrophils to inflamed area • It is very effective in ankylosing spondylitis, acute gout and psoriatic arthritis • It has prominent GI side effects • CNS side effects are severe headache, confusion, hallucinations, etc. • It is contraindicated in epileptics, psychiatric patients and drivers
4. Piroxicam	Oral, i.m. and topical gel Dose: 20 mg OD	<ul style="list-style-type: none"> • It has potent antiinflammatory effect • It is long-acting • Increased incidence of peptic ulcer and bleeding
5. Ketorolac	Oral, i.m., i.v., ophthalmic preparation and transdermal patch Dose: 10–20 mg QID	<ul style="list-style-type: none"> • It has potent analgesic effect and efficacy is almost equal to morphine. • It relieves pain without causing respiratory depression, hypotension and drug dependence • It is used in renal colic, postoperative and metastatic cancer pain
6. Mefenamic acid	Oral Dose: 250–500 mg TID	<ul style="list-style-type: none"> • It has analgesic, antipyretic and weak antiinflammatory effect • It is used in dysmenorrhoea, osteoarthritis, rheumatoid arthritis

■ Selective COX-2 Inhibitors ('Coxibs')

Some of the COX-2 inhibitors are parecoxib, etoricoxib, lumiracoxib, etc.

Parecoxib is a prodrug of valdecoxib and is administered parenterally; etoricoxib is given by enteral route (Table 7.4).

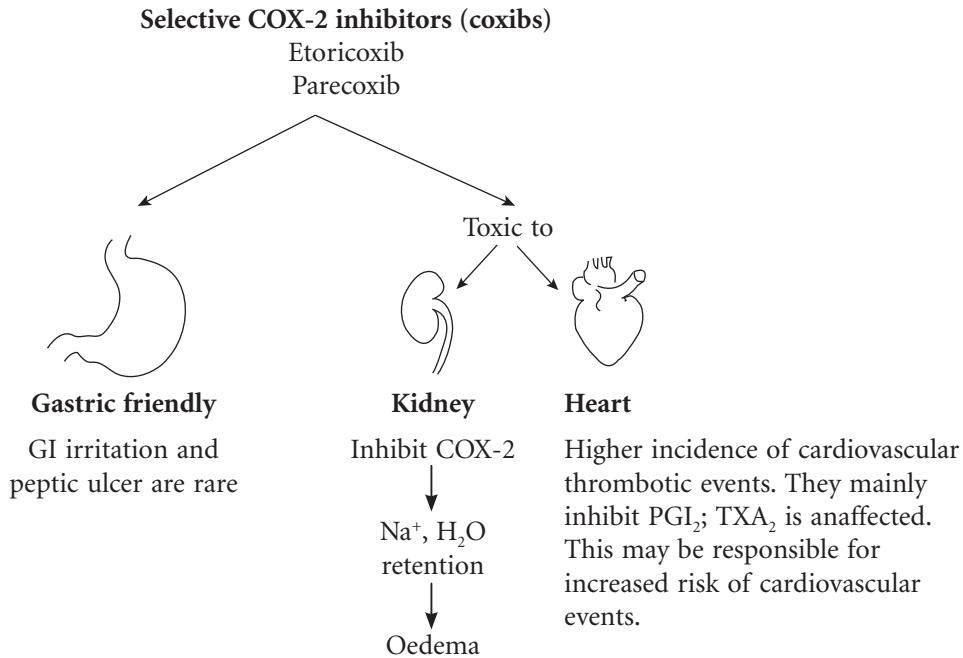

Table 7.4 Differences Between Nonselective COX and Selective COX-2 Inhibitors

Nonselective COX Inhibitors	Selective COX-2 Inhibitors
Analgesic effect +	Analgesic effect +
Antipyretic effect +	Antipyretic effect +
Antiinflammatory effect +	Antiinflammatory effect +
Antiplatelet effect +	No antiplatelet effect
GI side effects are marked ++	GI side effects are less (less ulcerogenic potential)
Renal toxicity + (sodium and water retention)	Renal toxicity +

+: present; ++: effect is more.

■ Paracetamol

Paracetamol is effective by oral and parenteral routes. It is well absorbed, widely distributed all over the body, metabolized in liver by sulphate and glucuronide conjugation. The metabolites are excreted in urine (Table 7.5).

Table 7.5 Differences Between Aspirin and Paracetamol

Aspirin	Paracetamol
1. It is a salicylate derivative	1. It is a <i>para</i> -aminophenol derivative
2. It has analgesic, antipyretic and potent antiinflammatory effects	2. It has potent antipyretic and analgesic effects with poor antiinflammatory activity
3. It causes GI irritation (nausea, vomiting, peptic ulcer and bleeding)	3. It usually does not produce gastric irritation
4. In large doses, it produces acid–base and electrolyte imbalance	4. It does not produce acid–base and electrolyte imbalance
5. It has antiplatelet action	5. It has no antiplatelet action
6. It has no specific antidote	6. <i>N</i> -acetylcysteine is the antidote
7. It is contraindicated in peptic ulcer, people with bleeding tendency, bronchial asthma and in children with viral infection	7. Paracetamol is the preferred analgesic and antipyretic in patients having peptic ulcer, bronchial asthma and in children

Uses

1. As antipyretic: To reduce body temperature during fever.
2. As analgesic: To relieve headache, toothache, myalgia, dysmenorrhoea, etc.
3. It is the preferred analgesic and antipyretic in patients with peptic ulcer, haemophilia, bronchial asthma and children.

Adverse effects

1. Side effects are rare, occasionally causes skin rashes and nausea.
2. Hepatotoxicity: with acute overdose or chronic use.
3. Nephrotoxicity is commonly seen on chronic use.

Acute paracetamol poisoning

Acute overdosage mainly causes hepatotoxicity—symptoms are nausea, vomiting, diarrhoea, abdominal pain, hypoglycaemia, hypotension, hypoprothrombinaemia, coma, etc. Death is usually due to hepatic necrosis.

Mechanism of toxicity and treatment (Fig. 7.5)

- The toxic metabolite of paracetamol is detoxified by conjugation with glutathione and gets eliminated.
- High doses of paracetamol cause depletion of glutathione levels. In the absence of glutathione, toxic metabolite binds covalently with proteins in the liver and kidney and causes necrosis.
- Alcoholics and premature infants are more prone to hepatotoxicity.
- *N*-acetylcysteine or oral methionine replenishes the glutathione stores of liver and protects the liver cells.
- Activated charcoal is administered to decrease the absorption of paracetamol from the gut.
- Charcoal haemoperfusion is effective in severe liver failure.
- Haemodialysis may be required in cases with acute renal failure.

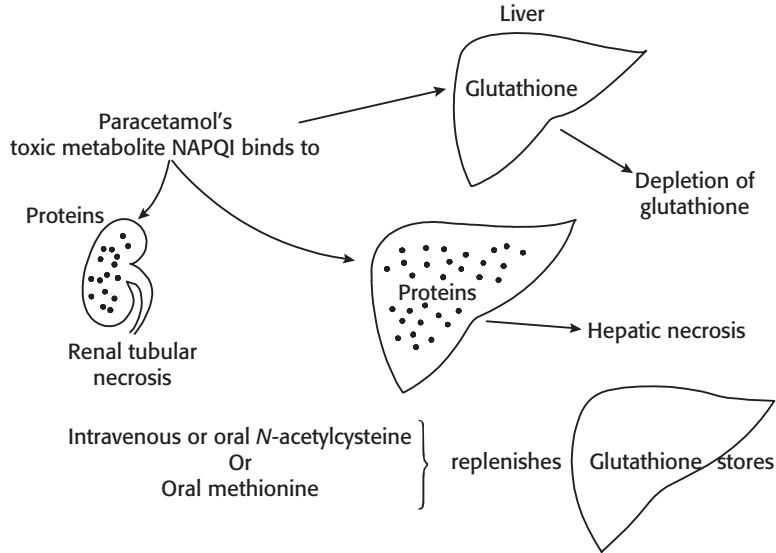

Fig. 7.5 Mechanism of paracetamol toxicity and its treatment. NAPQI, *N*-acetyl-*p*-benzo-quinoneimine.

Key Points for Dentists

- NSAIDs should be taken after food.
- NSAIDs should be avoided in patients with peptic ulcer as it may aggravate the condition.
- Preferred analgesics for patients with peptic ulcer are paracetamol and selective COX-2 inhibitors.
- Patients on aspirin should inform the doctor if surgery/dental procedure is planned.
- Educate patient about adverse effects and drug interactions of aspirin. Advise patient to report signs of bleeding, if any.
- The preferred analgesic in patients with chronic renal failure is paracetamol.

RESPIRATORY SYSTEM

Drugs Used in Treatment of Cough

Cough is a protective reflex, intended to remove irritants and accumulated secretions from the respiratory passages. Drugs used in the symptomatic treatment of cough are:

1. **Antitussives (cough centre suppressants)**
Codeine, pholcodine, noscapine, dextromethorphan, antihistamines, benzonatate.
2. **Pharyngeal demulcents**
Lozenges, linctuses, liquorice.
3. **Expectorants**
Sodium and potassium citrate, potassium iodide, guaiphenesin, ammonium chloride.
4. **Mucolytics**
Bromhexine, acetylcysteine, carbocisteine, ambroxol.

Cough may be:

1. **Productive cough:** Helps to clear the airway. Suppression of productive cough is harmful as it may lead to infections. Treatment includes antibiotics for infection, expectorants and mucolytics for cough.
2. **Nonproductive cough:** It is useless and should be suppressed.

Antitussives

They inhibit cough reflex by suppressing the cough centre in the medulla. They are used for the symptomatic treatment of dry unproductive cough. Antitussives should be avoided in children below the age of 1 year.

1. **Codeine:**

- a. Has cough centre suppressant effect.
- b. Causes mild CNS depression, hence drowsiness can occur.
- c. Causes constipation by decreasing intestinal movements.
- d. Should be avoided in children and asthmatics.

Codeine is administered orally, has mild analgesic and less addiction liability than morphine.

2. **Pholcodine:** Antitussive action is similar to codeine. It has no analgesic or addiction liability. It is administered orally and has a long duration of action.
3. **Noscapine:** It is an opium alkaloid with potent antitussive effect. It is useful in spasmodic cough. It has no analgesic effect, does not cause constipation, addiction or CNS depression. The side effects are nausea and headache.
4. **Dextromethorphan:** It is a centrally acting antitussive agent. It has no analgesic property, does not cause constipation and addiction; mucociliary function in respiratory passages is not affected.
5. **Antihistamines:** Diphenhydramine, chlorpheniramine, promethazine, etc. are useful in cough due to their sedative, antiallergic and anticholinergic actions. They produce symptomatic relief in cold and cough associated with allergic conditions of respiratory tract.
6. **Benzonatate:** It is a peripherally acting cough suppressant and chemically related to local anaesthetic, procaine. It acts on the pulmonary stretch receptors.

Pharyngeal Demulcents

Syrups, lozenges, linctuses or liquorice may be used when cough arises due to irritation above the larynx. They increase salivation and produce protective soothing effect on the inflamed mucosa.

Expectorants (Mucokinetics)

They increase the volume of bronchial secretion and reduce viscosity of the sputum; hence, cough becomes less tiring and productive. They include iodides, chlorides, bicarbonates, acetates, volatile oils, etc. These drugs are useful in the treatment of chronic cough.

Mucolytics

These agents break the thick tenacious sputum and lower the viscosity of sputum, so that the sputum comes out easily with less effort.

- **Bromhexine**

It is a semisynthetic agent used orally. It has potent mucolytic and mucokinetic effects.

Bromhexine $\xrightarrow{\text{liberates}}$ Lysosomal enzymes \longrightarrow Digests the mucopolysaccharides \longrightarrow Decreases viscosity of sputum \longrightarrow Cough becomes less tiring and productive.

The side effects are rhinorrhoea and lacrimation.

- **Acetylcysteine and carbocisteine**

Acetylcysteine is a mucolytic used as aerosol in the treatment of cough.

Acetylcysteine and carbocisteine \longrightarrow open disulphide bonds in mucoproteins of sputum \longrightarrow sputum becomes thin and less viscid \longrightarrow cough becomes less tiring and productive.

The side effects are nausea, vomiting and bronchospasm.

Carbocisteine is administered orally.

Key Points for Dentists

- Cough suppressants should be used only for dry cough.
- Productive cough should not be suppressed.
- Cough suppressants should not be used for infants.
- Patients on antihistamines should avoid driving, operating machinery, etc.

DRUGS USED IN TREATMENT OF BRONCHIAL ASTHMA

In bronchial asthma, there is impairment of airflow due to contraction of bronchial smooth muscle (bronchospasm), swelling of bronchial mucosa (mucosal oedema) and increased bronchial mucus secretion.

Several factors may precipitate attacks of asthma in susceptible individuals. They include allergy, infection and psychological factors. Airway obstruction in asthma is mainly due to the release of mediators from sensitized mast cells in the lungs. They are histamine, serotonin (5-HT), PGs, leukotrienes (LTC₄ and LTD₄), proteases, PAF, etc. Bronchial asthma may be either episodic or chronic.

Acute asthma: It is characterized by episode of dyspnoea associated with expiratory wheezing.

Chronic asthma: There is continuous wheeze and breathlessness on exertion; cough and mucoid sputum with recurrent respiratory infection are common.

Status asthmaticus (acute severe asthma): When an attack of asthma is prolonged with severe intractable wheezing, it is known as acute severe asthma.

Classification of antiasthmatic drugs

1. **Bronchodilators**
 - a. **Sympathomimetics**
 - i. Selective β_2 -adrenergic agonists: Salbutamol, terbutaline (short acting); salmeterol, formoterol (long acting).
 - ii. Nonselective: Adrenaline.
 - b. **Methylxanthines:** Theophylline, aminophylline, etophylline.
 - c. **Anticholinergics:** Ipratropium bromide, tiotropium bromide.
2. **Leukotriene receptor antagonists**
Zafirlukast, montelukast.

3. Mast cell stabilizers

Sodium cromoglycate, ketotifen.

4. Glucocorticoids

a. **Inhaled glucocorticoids:** Beclomethasone, budesonide, fluticasone.

b. **Systemic glucocorticoids:** Hydrocortisone, prednisolone, methylprednisolone.

5. Anti-IgE monoclonal antibody: Omalizumab.

Bronchodilators

Sympathomimetics

Mechanism of action

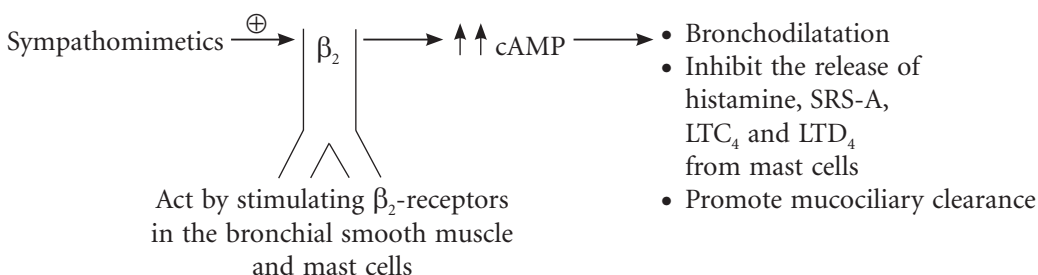

Adrenaline (nonselective sympathomimetic)

It produces prompt and powerful bronchodilatation by acting through β_2 -adrenergic receptors. It is useful in an acute attack of asthma – 0.2–0.5 mL of 1:1000 solution is given subcutaneously. Its use has declined because of its dangerous cardiac side effects (see p. 82).

Selective β_2 -adrenergic agonists (Table 7.6)

They are the first-line drugs for bronchial asthma. For mechanism of action—see above.

They are well tolerated when inhaled. At high doses, they may cause tremors, tachycardia, palpitation, hypokalemia and rarely cardiac arrhythmias.

Table 7.6 Selective β_2 -Agonists

Salbutamol and Terbutaline	Salmeterol	Formoterol
<i>Selective β_2-agonists:</i> On inhalation, they have a rapid onset (within 1–5 min) and short duration of action. They are preferred for acute attack of asthma. <i>Route and dose:</i> Inhalation, salbutamol 100–200 mcg every 6 hours, or as-and-when required through metered dose inhaler (MDI) to terminate an acute attack. Other routes of administration are oral, i.m. and i.v.	<i>Long-acting selective β_2-agonist:</i> It is preferred for maintenance therapy of asthma. It is not suitable for acute attack as it has a slow onset of action. <i>Route and dose:</i> Inhalation, 50 mcg twice daily.	<i>Long-acting selective β_2-agonist:</i> It has a rapid onset and long duration of action. It is preferred for prophylaxis due to its long duration of action. <i>Route and dose:</i> Inhalation, 12–24 mcg twice daily

Methylxanthines

Use of methylxanthines in asthma has markedly diminished because of their narrow margin of safety and availability of better antiasthmatic drugs (selective β_2 -agonists, inhaled steroids and leukotriene antagonists). Methylxanthines are the third- or fourth-line drugs in the treatment of asthma.

Mechanism of action

- Theophylline } → Inhibit phosphodiesterase (PDE) → ↑cAMP →
 - Aminophylline }
- Bronchodilatation
 - Inhibit the release of histamine and SRS-A from mast cells
 - Improve mucociliary clearance in respiratory passages

Methylxanthines inhibit phosphodiesterases (PDEs), thereby prevent degradation of cAMP and cGMP. This results in accumulation of intracellular cAMP and in some tissues cGMP. Methylxanthines are competitive antagonists at adenosine receptors, which also results in bronchodilatation.

Pharmacokinetics

Methylxanthines are well absorbed after oral and parenteral administration; food delays the rate of absorption of theophylline. They are well distributed all over the body; cross placental and blood–brain barriers. They get metabolized in liver and are excreted in urine.

1. **Theophylline:** It is poorly water soluble, hence not suitable for injection. It is available for oral administration.
2. **Aminophylline:** It is water soluble but highly irritant. It can be administered orally or slow intravenously.
3. **Etophylline:** It is water soluble and can be given by oral, intramuscular (i.m.) or intravenous (i.v.) routes.

Adverse effects

They have a narrow margin of safety. They can cause tachycardia, palpitation, hypotension (due to vasodilatation) and sometimes sudden death due to cardiac arrhythmias (Fig. 7.6).

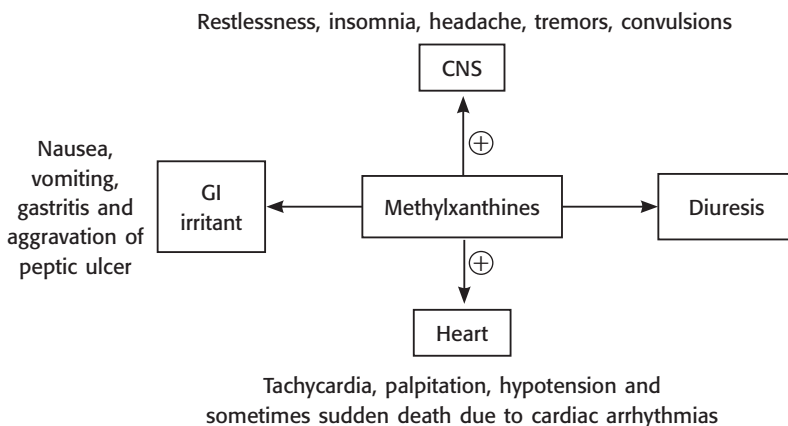
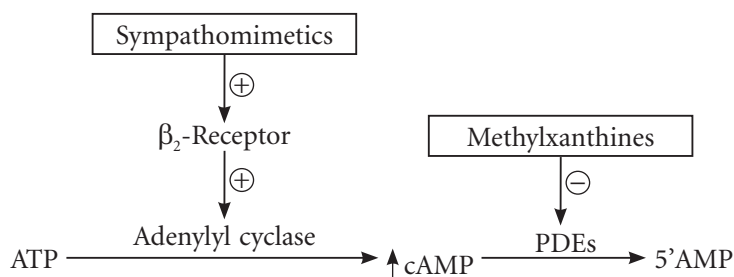

Fig. 7.6 Adverse effects of methylxanthines.

Drug interactions

1. Sympathomimetics × Methylxanthines



Methylxanthines potentiate the effects of sympathomimetics:

- Bronchodilatation (beneficial effect).
 - Cardiac stimulation (harmful effect).
- Phenytoin/rifampicin/phenobarbitone × theophylline:** They are enzyme inducers, hence, they accelerate the metabolism of theophylline and decrease its effect.
 - Cimetidine/ciprofloxacin/erythromycin × theophylline:** They are enzyme inhibitors, hence, they potentiate the effects of theophylline by interfering with its metabolism.

Uses of methylxanthines

- Bronchial asthma and chronic obstructive pulmonary disease (COPD).
- Apnoea in premature infants: Theophylline is used orally or intravenously to reduce the duration of episodes of apnoea.

Anticholinergics

Ipratropium bromide and tiotropium bromide are atropine substitutes. They selectively block the effects of acetylcholine in the bronchial smooth muscles and cause bronchodilatation. They have a slow onset of action and are less effective than sympathomimetic drugs in bronchial asthma. These anticholinergics are the preferred bronchodilators in COPD and can also be used in bronchial asthma. They are administered by inhalational route. Combined use of ipratropium with β_2 -adrenergic agonists produce greater and more prolonged bronchodilatation, hence, they are used in acute severe asthma.

Leukotriene Antagonists

These drugs competitively block the effects of cysteinyl leukotrienes (LTC_4 , LTD_4 and LTE_4) on bronchial smooth muscle.

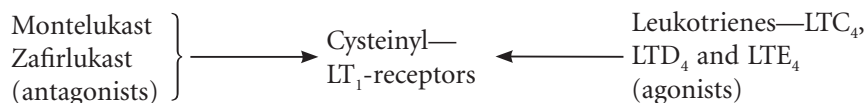

Thus, they produce bronchodilatation, suppress bronchial inflammation and decrease hyperreactivity. They are well absorbed after oral administration, highly bound to plasma proteins and metabolized extensively in the liver. They are effective for prophylactic treatment of mild asthma. They are well tolerated and produce fewer adverse effects—headache, skin rashes and rarely eosinophilia.

Mast Cell Stabilizers

Sodium cromoglycate and ketotifen are mast cell stabilizers. They are not bronchodilators. They inhibit the release of various mediators—histamine, LTs, PGs, PAF, etc. by stabilizing the mast cell membrane (Fig. 7.7). They also reduce bronchial hyperreactivity to some extent; but antigen–antibody reaction (AG–AB reaction) is not affected.

Sodium cromoglycate is not effective orally as it is poorly absorbed from the gut. In bronchial asthma, sodium cromoglycate is given by inhalation.

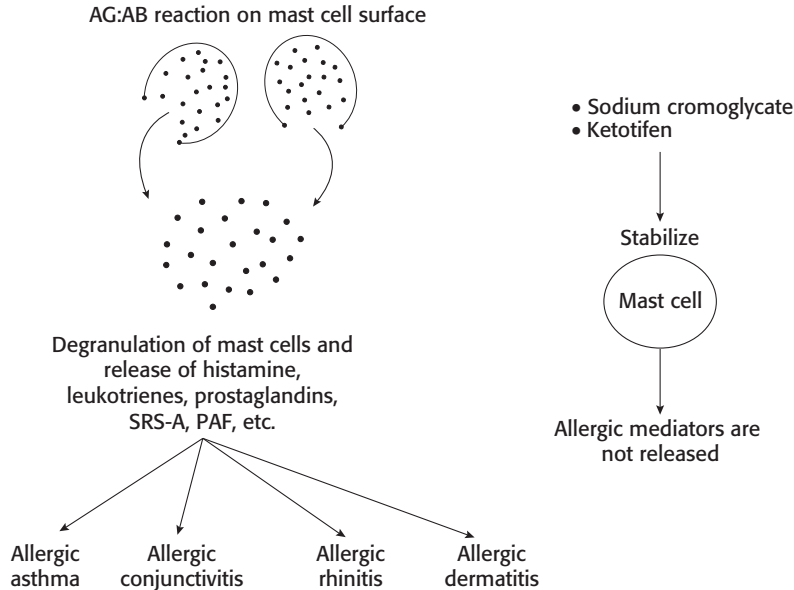

Fig. 7.7 Mechanism of action of mast cell stabilizers.

Uses

1. **Allergic asthma:** Sodium cromoglycate is used as a prophylactic agent to prevent bronchospasm induced by allergens and irritants.
2. It can also be used in allergic conjunctivitis, allergic rhinitis, allergic dermatitis, etc. by topical route as a prophylactic agent.

Ketotifen: Mechanism of action is similar to sodium cromoglycate, has additional H_1 -blocking effect. It is orally effective but has a slow onset of action.

Glucocorticoids

1. **Systemic:** Hydrocortisone, prednisolone, methylprednisolone and others.
2. **Inhalational:** Beclomethasone, budesonide, fluticasone, etc.

Glucocorticoids induce synthesis of 'lipocortin', which inhibits phospholipase A_2 and thereby prevent the formation of various mediators such as PGs, TXA_2 , SRS-A, etc. Glucocorticoids have anti-allergic, anti-inflammatory and immunosuppressant effects. They:

1. Suppress inflammatory response to AG–AB reaction.

2. Decrease mucosal oedema.
3. Reduce bronchial hyperreactivity.

Glucocorticoids do not have direct bronchodilating effect, but they potentiate the effects of β -adrenergic agonists.

Inhaled glucocorticoids such as beclomethasone, budesonide and fluticasone are used as prophylactic agents in bronchial asthma. They are well tolerated. Systemic side effects are rare with these agents. The common side effects are hoarseness of voice, dysphonia and oropharyngeal candidiasis. These can be reduced by using a spacer, rinsing the mouth after each dose and can be treated effectively by topical antifungal agent, nystatin or hamycin.

Combination of a long-acting β -agonist (LABA) with steroid is available, e.g. fluticasone + salmeterol; budesonide + formoterol. They have synergistic action; used in bronchial asthma and COPD.

Systemic glucocorticoids are used in acute severe asthma and chronic severe asthma. Long-term use of systemic steroids produce severe side effects such as gastric irritation, Na^+ and water retention, hypertension, muscle weakness, osteoporosis, hypothalamo–pituitary–adrenal axis (HPA axis) suppression, etc. (see pp. 274 and 275).

■ Anti-IgE Monoclonal Antibody: Omalizumab

Omalizumab prevents the binding of immunoglobulin E (IgE) to mast cell and thus prevents mast cell degranulation. It has no effect on IgE already bound to mast cells. It is administered parenterally. It is used in moderate-to-severe asthma and allergic disorders such as nasal allergy, food allergy, etc. It is approved for use in patients above 12 years of age. It causes local side effects such as redness, stinging, itching and induration.

■ Inhalational Devices

They are:

- **Metered dose inhaler (MDI):** Can be used alone or with spacer devices.
- **Dry powder inhalers:** Spinhaler and Rotahaler.
- **Nebulizers:** Useful in acute severe asthma, COPD and for delivering drug in young children.

Antiasthmatic agents available as inhalants are β_2 -adrenergic agonists (salbutamol, terbutaline, salmeterol and formoterol), anticholinergics (ipratropium bromide and tiotropium bromide), mast cell stabilizers (sodium cromoglycate and nedocromil) and glucocorticoids (fluticasone, beclomethasone, budesonide, etc.).

■ Treatment of Acute Severe Asthma (Status Asthmaticus)

1. Humidified oxygen inhalation.
2. Nebulized β_2 -adrenergic agonist (salbutamol 5 mg/terbutaline 10 mg) + anticholinergic agent (ipratropium bromide 0.5 mg).
3. Systemic glucocorticoids: Intravenous hydrocortisone 200 mg i.v. stat followed by i.v. hydrocortisone 100 mg q6h or oral prednisolone 30–60 mg/day, depending on the patient's condition.

4. Intravenous fluids to correct dehydration.
5. Potassium supplements: To correct hypokalaemia produced by repeated doses of salbutamol/terbutaline.
6. Sodium bicarbonate to treat acidosis.
7. Antibiotics to treat infection.

Key Points for Dentists

- Elective dental procedures should be avoided during attack of severe asthma.
- Local anaesthetic preparation containing adrenaline is contraindicated in patients on theophylline.
- The following drugs should be avoided in patients with bronchial asthma:
 - NSAIDs: Aspirin, ibuprofen, diclofenac, etc. (paracetamol can be used).
 - β -Adrenergic blockers.
 - Cholinergic agonists.

This page intentionally left blank

Drugs Used in the Treatment of Gastrointestinal Diseases

EMETICS AND ANTIEMETICS

Nausea and vomiting are protective reflexes that help to remove toxic substances from the gastrointestinal tract (GIT). They are symptoms of altered function but are not diseases. Nausea denotes the feeling of impending vomiting, whereas vomiting refers to the forceful expulsion of the contents of the stomach and upper intestinal tract through the mouth. Retching is the laboured rhythmic respiratory activity that usually precedes vomiting.

Mechanism of vomiting

The act of vomiting is controlled by the vomiting centre in the medulla. Stimuli are relayed to this centre from peripheral areas, i.e. gastric mucosa and other parts of GIT. Sensory stimuli also arise within the central nervous system (CNS) itself (i.e. cerebral cortex and vestibular apparatus)—the impulses are transmitted to the vomiting centre (Fig. 8.1).

The lack of blood–brain barrier (BBB) at the chemoreceptor trigger zone (CTZ) allows it to be directly stimulated by blood-borne drugs and toxic substances. Nausea and vomiting may be the symptoms of pregnancy, serious organic disturbances of almost any of the viscera or may be produced by infection, drugs, radiation, painful stimuli, motion sickness, metabolic and emotional disturbances. The main neurotransmitters involved in the control of vomiting are acetylcholine (ACh), histamine, 5-hydroxytryptamine (5-HT) and dopamine.

■ Emetics

The drugs that cause vomiting are called emetics. Examples are mustard, common salt, ipecac and apomorphine. Mustard and common salt are commonly used household emetics. Syrup ipecac is a safer emetic than apomorphine. Emetics are indicated in certain cases of poisoning.

Contraindications for the use of emetics are:

1. Children.
2. Unconscious patients.
3. Corrosive and caustic poisoning.
4. Poisoning due to CNS stimulants.
5. Kerosene poisoning.

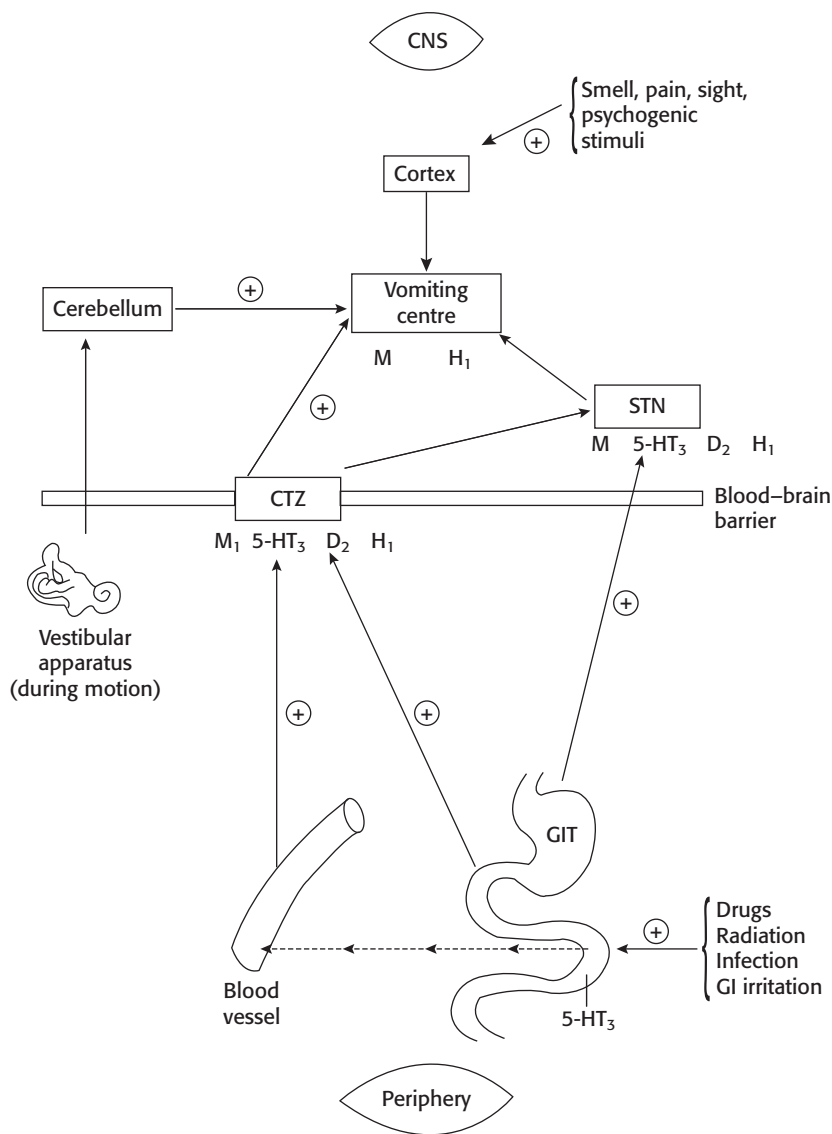

Fig. 8.1 Central and visceral structures involved in emesis. CTZ, chemoreceptor trigger zone; STN, solitary tract nucleus.

■ Antiemetics

The drugs that are used to prevent or control vomiting are called antiemetics (Table 8.1).

Classification

1. **Anticholinergics:** Scopolamine (hyoscine), dicyclomine.
2. **Antihistamines (H₁-blockers):** Dimenhydrinate, diphenhydramine, cyclizine, meclizine, hydroxyzine, promethazine, doxylamine, cinnarizine.

Table 8.1 Antiemetics with their Uses and Side Effects

Drugs	Uses	Important Side Effects
1. Anticholinergics (Scopolamine)	Motion sickness	Sedation, dryness of mouth, blurred vision and urinary retention
2. Antihistamines	Motion sickness, morning sickness, drug-induced, postoperative, radiation sickness, cancer chemotherapy-induced vomiting	Drowsiness and dryness of mouth
3. 5-HT ₃ -receptor antagonists	Cancer chemotherapy-induced vomiting, radiation sickness, postoperative vomiting	Headache, dizziness and diarrhoea
4. Prokinetic drugs <ul style="list-style-type: none"> • Metoclopramide • Domperidone 	<ul style="list-style-type: none"> • Drug-induced, disease-induced, postoperative, cancer chemotherapy-induced vomiting and radiation sickness • Preferred antiemetic in children, levodopa-induced vomiting 	<ul style="list-style-type: none"> • Drowsiness, dizziness, diarrhoea, acute muscle dystonias and other extra pyramidal symptoms • Dry mouth, diarrhoea and headache
5. Neuroleptics	Drug-induced, disease-induced, postoperative, cancer chemotherapy and radiation induced vomiting	Extrapyramidal symptoms, sedation, dystonic reactions and orthostatic hypotension
6. Dronabinol	Vomiting due to cytotoxic drugs and radiation sickness	Sedation, dysphoria, hallucinations and drug dependence
7. Glucocorticoids (adjuvant antiemetics)	Adjuvant antiemetic along with ondansetron or metoclopramide in cancer chemotherapy-induced vomiting	Metabolic disturbances
8. Benzodiazepines (adjuvant antiemetics)	Psychogenic and anticipatory vomiting	Sedation and drowsiness

3. **5-HT₃-receptor antagonists:** Ondansetron, granisetron.
4. **Prokinetic agents:** Metoclopramide, domperidone.
5. **Neuroleptics:** Chlorpromazine, fluphenazine, prochlorperazine, haloperidol.
6. **Cannabinoids:** Dronabinol.
7. **Adjuvant antiemetics:**
 - a. **Glucocorticoids:** Betamethasone, dexamethasone, methylprednisolone.
 - b. **Benzodiazepines:** Lorazepam, alprazolam.

▶ Anticholinergics

Scopolamine (hyoscine) is the drug of choice to prevent motion (travel) sickness (see p. 69). It blocks afferent impulses from vestibular apparatus to the vomiting centre by its anticholinergic action. Its sedative effect also contributes to its antiemetic effect. Scopolamine is not effective for other types of vomiting.

▶ Antihistamines (H₁-blockers)

H₁-blockers are mainly useful for the prevention of motion sickness. They are also effective in morning sickness, postoperative and other types of vomiting. Dimenhydrinate, diphenhydramine, doxylamine,

promethazine, cyclizine and meclizine are some of the H_1 -blockers that have antiemetic properties. Their antiemetic effect is due to sedative and central anticholinergic actions. Cyclizine and meclizine have less sedative effect. Meclizine has longer duration of action (12–24 h).

5-HT₃ Receptor Antagonists

Ondansetron is the prototype drug. Other drugs are granisetron, dolasetron and palonosetron. Their antiemetic effect is mainly due to the blockade of 5-HT₃ receptors on vagal afferents in the gut. In addition, they also block 5-HT₃ receptors in the CTZ and solitary tract nucleus (STN).

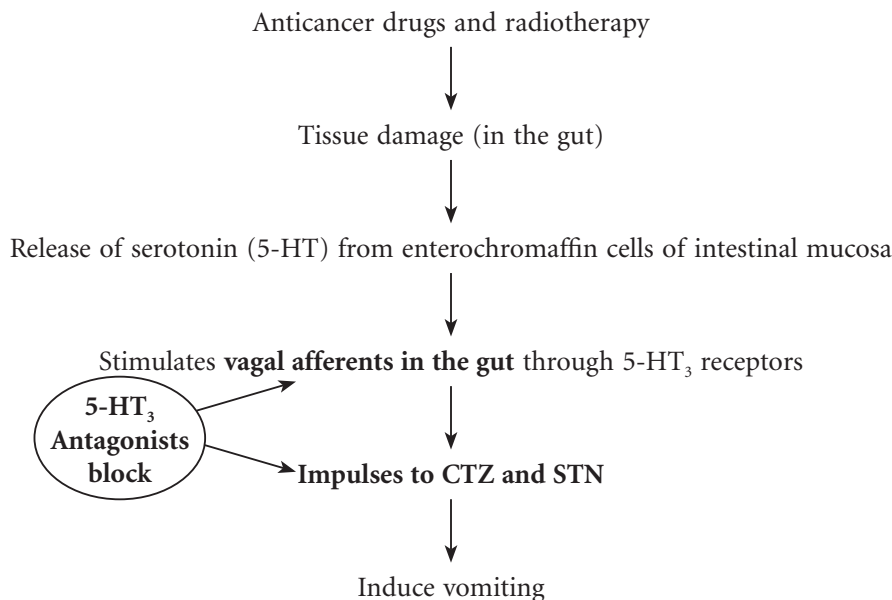

Ondansetron and other 5-HT₃ antagonists control vomiting by blocking emetogenic impulses in the gut and their central relay (CTZ and STN).

Pharmacokinetics

5-HT₃ antagonists are well absorbed after oral administration—ondansetron undergoes extensive first-pass metabolism. The metabolites are excreted in urine and faeces. These agents are also available for intravenous administration. Ondansetron can also be administered intramuscularly. Granisetron is more potent and longer acting than ondansetron.

Uses

1. 5-HT₃ antagonists are the most effective agents for prevention and treatment of anticancer drug-induced nausea and vomiting.
2. They are also effective in hyperemesis of pregnancy, postoperative and postradiation vomiting; but they are ineffective against motion sickness.

Adverse effects

5-HT₃ antagonists are well tolerated. They may cause headache, dizziness and diarrhoea.

Prokinetic Drugs

Drugs that promote coordinated movement of upper GIT and hasten gastric emptying are called prokinetic drugs.

Metoclopramide

Metoclopramide is a D_2 -receptor antagonist. It has two important actions—central and peripheral.

- **Central actions:** The antiemetic effect of metoclopramide is mainly due to blockade of D_2 -receptors in CTZ. At high concentration, it also blocks $5-HT_3$ receptors (Fig. 8.2).

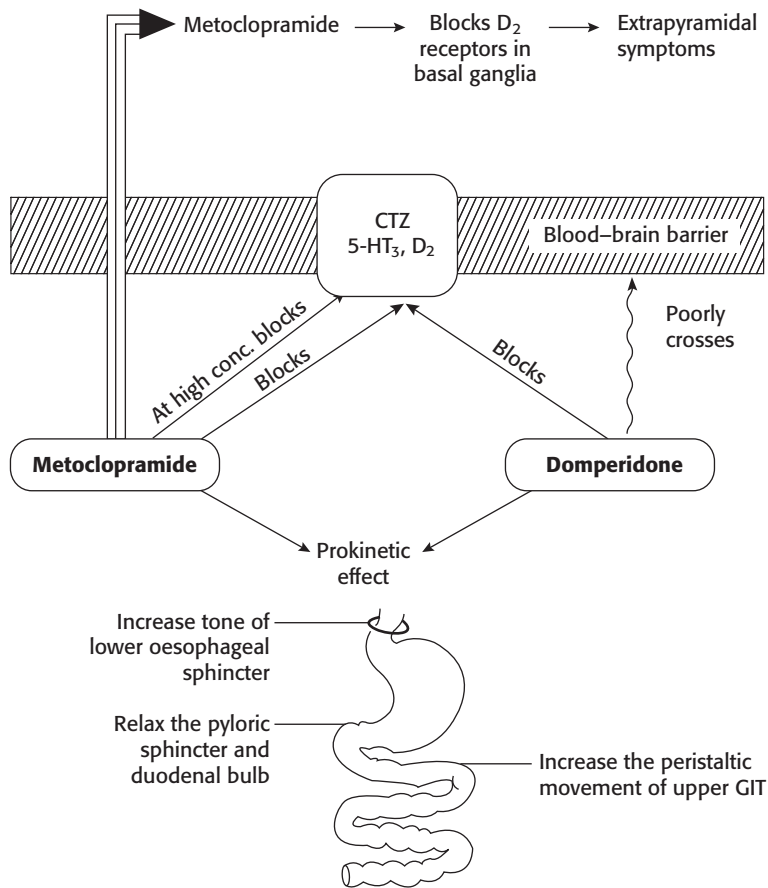
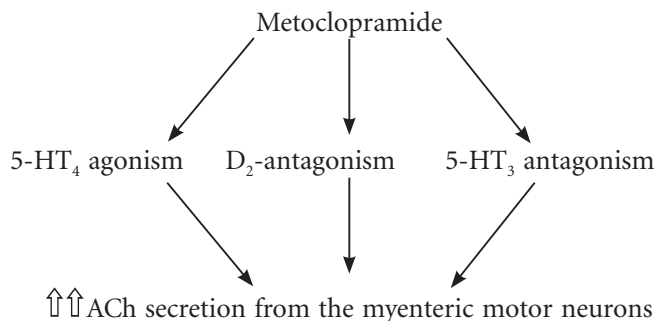

Fig. 8.2 Effects of metoclopramide and domperidone.

- **Prokinetic effect on upper GIT:** Metoclopramide enhances release of ACh from myenteric neurons. This effect is due to D_2 -antagonism and $5-HT_4$ agonism in the GI tract. Thus, peripherally, it has prokinetic effect on upper GIT (Fig. 8.2) and enhances the rate of gastric and duodenal emptying.



The effects of metoclopramide on the upper GI tract are:

1. Increase in tone of lower oesophageal sphincter (LES).
2. Increase in tone and amplitude of antral contractions.
3. Relaxation of pyloric sphincter.
4. Increase in peristalsis of small intestine.

Thus, it promotes forward movement of contents in the upper GIT.

Pharmacokinetics

Metoclopramide is rapidly absorbed after oral administration. It can also be administered by i.m. or i.v. routes. Onset of action is within half-an-hour after oral dose; a few minutes after parenteral administration. It has a short half-life of 4 hours; is poorly bound to plasma proteins; crosses blood–brain barrier. The drug is partly metabolized and excreted in urine.

Uses

1. As an antiemetic: Metoclopramide is effective for the prevention and treatment of:
 - a. Disease-associated vomiting.
 - b. Drug-induced vomiting (not used to control levodopa-induced vomiting).
 - c. Postoperative vomiting.
 - d. Cancer chemotherapy-induced vomiting.
 - e. Vomiting due to radiation sickness.

It is less effective against motion sickness and vomiting due to labyrinthine disorders.

2. Gastroesophageal reflux disease (GERD): Metoclopramide produces symptomatic relief in patients with reflux oesophagitis by increasing the tone of lower oesophageal sphincter. By prokinetic effect, it also reduces the volume of gastroduodenal contents that reflux into oesophagus. It is less effective than proton pump inhibitors (PPIs) and H₂-blockers.
3. To alleviate symptoms associated with gastric stasis in patients with diabetes, postoperative or idiopathic gastroparesis: Gastric stasis is characterized by upper abdominal discomfort, distension, bloating, nausea, vomiting, etc. By prokinetic effect, it controls the above symptoms.
4. To stimulate gastric emptying during gastrointestinal radiological procedures and also before general anaesthesia in emergency surgeries.
5. Metoclopramide has been used in the treatment of intractable hiccups.

Adverse effects

They are drowsiness, dizziness and diarrhoea. Acute dystonias (spasm of muscles of face, tongue, neck and back) can occur. Other extrapyramidal symptoms (EPS: tremor, rigidity, etc.) are due to blockade of D₂-receptors in basal ganglia (drug-induced parkinsonism). Acute dystonias can be treated with centrally acting anticholinergics (e.g. benzhexol, benztropine, etc.) or antihistamines with anticholinergic action (e.g. promethazine, diphenhydramine, etc.).

Long-term use may lead to gynaecomastia, galactorrhoea and menstrual irregularities due to blockade of inhibitory effect of dopamine on prolactin release.

Drug interactions

Metoclopramide accelerates the absorption of diazepam but reduces digoxin absorption by its prokinetic effect.

Metoclopramide and levodopa: Metoclopramide crosses BBB, blocks D₂-receptors in the basal ganglia, thus interfering with the anti-parkinsonian effect of levodopa. Hence, it is not used to treat levodopa-induced vomiting.

Domperidone

It is a butyrophenone derivative and has effects almost similar to metoclopramide. Its antiemetic and prokinetic effects are due to blockade of dopamine (D₂)-receptors (Fig. 8.2). It is less potent and less efficacious than metoclopramide. It poorly crosses BBB, hence extrapyramidal side effects are rare, but it increases the prolactin level. Atropine blocks the prokinetic effect of metoclopramide but not that of domperidone. It is usually administered orally, but its oral bioavailability is low because of extensive first-pass metabolism; is metabolized in liver and metabolites are excreted in urine. Domperidone is a preferred antiemetic in children, as it rarely produces EPS. It counteracts vomiting induced by levodopa without affecting its anti-parkinsonian effect as it poorly crosses BBB. Hence, it is preferred over metoclopramide to treat vomiting induced by these drugs. The important side effects are dryness of mouth, diarrhoea, headache, skin rashes, galactorrhoea and menstrual irregularities.

Neuroleptics

They are potent antiemetics. Their antiemetic effect is due to blockade of D₂-receptors in the CTZ. In addition, they have anticholinergic and antihistaminic actions. Among these, prochlorperazine is commonly used as an antiemetic. They are effective in the treatment of vomiting due to drugs, uraemia and systemic infections. These drugs are not used for morning sickness. Neuroleptics are not as effective as ondansetron and metoclopramide in cytotoxic drug-induced vomiting and radiation sickness. They are less effective in motion sickness. The common side effects are sedation, extrapyramidal symptoms, dryness of mouth, hypotension, etc. (see pp. 188 and 189).

Cannabinoids

Dronabinol

It is the principal psychoactive component of marijuana and is used to prevent cancer chemotherapy-induced vomiting not responding to other antiemetics. It is effective orally. It produces serious side effects, such as sedation, hallucinations, disorientation, tachycardia, palpitation, increased appetite and drug dependence—hence kept as a reserve antiemetic.

Adjuvant Antiemetics

Glucocorticoids

Glucocorticoids, such as dexamethasone, betamethasone and methylprednisolone are used as adjuvant antiemetics. These agents are commonly used in combination with ondansetron or metoclopramide in the treatment of anticancer drug-induced vomiting. The beneficial effect of steroids is due to their antiinflammatory property and inhibition of prostaglandin (PG) synthesis.

Benzodiazepines

Lorazepam and alprazolam are used to control psychogenic and anticipatory vomiting. The beneficial effect is mainly due to their sedative, amnesic and antianxiety effects.

Key Points for Dentists

- Emetics should not be used in unconscious patients and poisoning due to kerosene and other petroleum products.
- Antiemetics are effective if given at least ½–1 h before travel to prevent motion sickness. Scopolamine patch should be applied 4 h before start of journey.
- Domperidone is the preferred antiemetic in children.
- 5-HT₃ antagonists are very effective in preventing cancer chemotherapy-induced vomiting.
- Acute dystonias can occur with metoclopramide.

ANTIDIARRHOEAL AGENTS

Generally the term 'diarrhoea' denotes passage of unusually loose or watery stools at least three times or more in a 24 hour period. Based on the pattern of onset, there are two types of diarrhoeas, i.e. acute and chronic. In most of the cases, acute diarrhoeas are caused by infectious agents. In acute diarrhoea, irrespective of the aetiology, emphasis is given to prevent dehydration, which is responsible for most of the mortalities. Diarrhoea is called chronic when it persists for more than 2 weeks. In chronic diarrhoea, finding out the cause is important for effective management.

■ Management of Diarrhoea

1. **Nonspecific therapy**
 - a. Oral and parenteral rehydration.
 - b. Antimotility and antisecretory agents:
 - i. *Opioids*: Codeine, diphenoxylate, loperamide.
 - ii. *α-Adrenergic-receptor agonist*: Clonidine.
2. **Specific therapy**: Antimicrobial agents, e.g. ciprofloxacin, doxycycline, metronidazole, etc.

◆ Oral Rehydration Solution (ORS)

In acute diarrhoea, death is usually due to dehydration rather than the specific infective organism. Hence, it is important to maintain water and electrolyte balance with proper fluid replacement. Oral rehydration seems to be the simplest, safest, least expensive and lifesaving method of choice for acute diarrhoea. WHO-ORS contains sodium chloride 2.6 g, potassium chloride 1.5 g, sodium citrate 2.9 g and glucose 13.5 g. It has to be dissolved in 1 L of water. This provides sodium 75 mM, potassium 20 mM, chloride 65 mM, citrate 10 mM and glucose 75 mM. In case of severe diarrhoea with dehydration, intravenous fluids are indicated. **Super ORS**, an improved form of ORS with substitution of glucose with boiled rice powder, helps in rehydration and also decreases the frequency of diarrhoea.

◆ Antimotility and Antisecretory Agents

Codeine: It is a natural opium alkaloid. It reduces GI motility and also has antisecretory effect. It has a significant constipating effect, which is useful in the symptomatic treatment of diarrhoea. It should be cautiously administered in children.

Diphenoxylate: It is structurally related to pethidine. It has a very potent antidiarrhoeal effect. In high doses, it has abuse liability, hence is usually available in combination with a small dose of atropine to discourage abuse or overdosage. The side effects are constipation, paralytic ileus and drug addiction. This drug has been banned in many countries.

Loperamide: It is an opiate analogue and has more potent antidiarrhoeal effect than morphine. By interacting with μ -opioid receptors in the gut, loperamide reduces GI motility and increases the anal sphincter tone. It decreases secretion induced by cholera toxin and some toxins of *Escherichia coli*. It is orally effective and has a rapid onset of action. It poorly penetrates BBB and has no abuse potential. The usual dose of loperamide is 4 mg stat and then 2 mg after each loose stool, but the maximum dose should not exceed 16 mg in 24 h. It has been used in both acute and chronic diarrhoeas. It can also be used in travellers' diarrhoea. The toxic effects are skin rashes, headache and paralytic ileus. It should not be used in children less than 4 years of age.

Antimotility drugs produce only symptomatic relief in diarrhoea and should be avoided in acute infectious diarrhoeas. These drugs also increase intraluminal pressure; hence they should be avoided in inflammatory bowel disease (IBD).

Key Points for Dentists

- Rehydration is the first step in the management of acute diarrhoea.
- Antimotility drugs should be avoided in acute infectious diarrhoea.

LAXATIVES (PURGATIVES, CATHARTICS)

Laxatives are drugs that facilitate evacuation of formed stools from the bowel. Purgatives cause evacuation of watery stools. The terms laxatives, purgatives and cathartics are often used interchangeably.

Classification (according to mechanism of action)

1. **Bulk laxatives**
Dietary fibre—Bran, methylcellulose, ispaghula (isabgol).
2. **Stool softeners (stool-wetting agents)**
Docusates, liquid paraffin.
3. **Stimulant or irritant laxatives**
Phenolphthalein, bisacodyl, sodium picosulphate.
Anthraquinone derivatives—Senna, cascara sagrada.
4. **Osmotic laxatives**
Magnesium sulphate, magnesium hydroxide, sodium phosphate, sodium sulphate, sodium potassium tartrate, lactulose.

■ Bulk-forming Laxatives

They are indigestible, hydrophilic substances like bran, methylcellulose, agar, ispaghula, etc., which absorb water, swell up and increase the bulk of stools. They cause mechanical distension, so stimulate peristalsis and promote defaecation. It takes 1–3 days for the evacuation of formed stools. Ispaghula is obtained from the seed of *Plantago ovata*. Large amount of water should be taken with bulk purgatives to avoid intestinal obstruction. Fibre diet should be encouraged in patients with irritable bowel syndrome, but should be avoided in those with megacolon or megarectum. The side effects include abdominal discomfort and flatus.

■ Stool Softeners (Stool-wetting Agents)

● Docusates

Common docusate salts are dioctyl sodium sulphosuccinate, dioctyl calcium sulphosuccinate and dioctyl potassium sulphosuccinate. They are anionic detergents. They lower the surface tension of stool, thereby cause accumulation of fluid and fatty substance, thus softening the stools. These agents act within 1–3 days. They are administered orally or as a retention enema. Docusates increase the absorption of liquid paraffin, hence should not be given together.

● Liquid Paraffin (Note the 'L's')

Liquid paraffin is a mineral oil and is administered orally. It softens stools. It also has a Lubricant effect, and thus helps in smooth defaecation. It is useful in patients with cardiac disease because it prevents straining during defaecation.

Adverse effects of liquid paraffin

1. Lipid pneumonia may occur due to entry of the drug into lungs; hence, liquid paraffin should not be given at bed time and in lying down position.
2. Long-term use may cause malabsorption of vitamin A, D, E and K (fat-soluble vitamins).
3. Leakage of faecal matter through anal sphincter may lead to soiling of clothes.

■ Stimulant (Irritant) Laxatives

These agents have direct action on enteric neurons and GI mucosa. They increase prostaglandin (PG) and cyclic adenosine monophosphate (cAMP) levels, but inhibit Na^+ , K^+ -ATPase activity in the intestinal mucosa. This causes an increased secretion of water and electrolytes by the mucosa, thus stimulating peristalsis. The site of action of these drugs is in the colon. They cause evacuation of semifluid stools. Chronic use of stimulant laxatives may cause atonic colon. Large doses may cause loss of fluid and electrolytes. They are contraindicated in pregnancy, as they cause reflex stimulation of uterus.

● Phenolphthalein

Its purgative action was discovered accidentally. The site of action is on large intestine. It is highly toxic, hence is not used.

● Bisacodyl

It is available as an enteric-coated oral tablet and also as a rectal suppository. It is poorly absorbed after oral administration and undergoes activation by esterases in the bowel. Hence, the effect is seen only after 6–8 h of oral administration. Therefore, it is usually given at bedtime. Rectal suppositories act more rapidly within an hour by irritation of rectal mucosa. Bisacodyl is used in constipation and to empty the bowel before endoscopy, surgery and radiological investigations. The side effects are local irritation and inflammation.

● Sodium Picosulphate

It is a stimulant purgative given orally at bedtime. It can be used to evacuate the bowel before surgery or colonoscopy.

Anthraquinone Derivatives

The popular anthracene purgatives are senna and cascara. They take 6–7 h to act; hence, they are usually administered at bed time to produce their effect in the morning. They are poorly absorbed in the small intestine. The unabsorbed portion reaches the colon, where it is reduced by bacteria to anthrol that acts locally and induces purgation. They should not be prescribed to lactating mothers, as they are secreted in milk. The side effects are skin rashes, black pigmentation of the colonic mucosa and discolouration of urine.

Osmotic/Saline Laxatives

These are the most powerful and rapid-acting laxatives. They are salts of magnesium, sodium or potassium. Those having magnesium or phosphate are known as saline laxatives. When given orally, they are not absorbed from the gut, remain in the lumen and exert osmotic effect. They draw water into the lumen, distend the bowel, which then stimulates peristalsis resulting in purgation. In addition, magnesium salts cause release of cholecystokinin. To mask the bitter taste, they are often administered with fruit juice. The important osmotic laxatives are magnesium sulphate (epsom salt), magnesium hydroxide (milk of magnesia), sodium phosphate, lactulose, etc. They should be avoided in young children and patients with renal failure, as they may cause CNS or cardiac depression.

Sodium phosphate is commonly used orally for colon preparation before surgery or colonoscopy. It can also be used as an enema. Sodium salts should be avoided in cardiac patients.

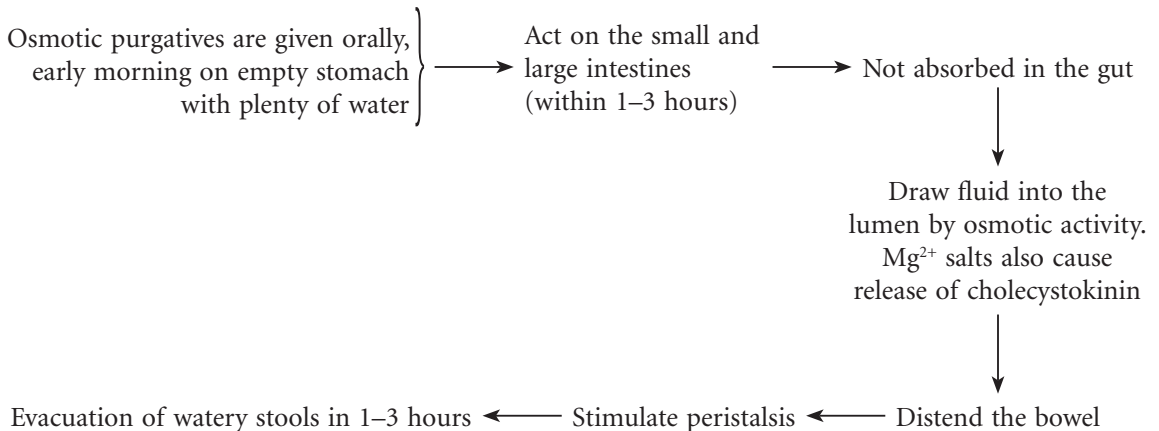

Lactulose

Lactulose is a disaccharide of fructose and galactose. Lactulose is available as liquid and powder. On oral administration, it is not absorbed through GI mucosa. Colonic bacteria convert it into short-chain fatty acids, which exert osmotic effect—draw fluid into the lumen and distend it; thus they are useful in constipation. It can be used to treat constipation in children and pregnant women. Lactulose is used in hepatic coma to reduce blood ammonia levels (Fig. 8.3)

It should be taken with plenty of water. It produces soft-to-loose stools. The side effects include abdominal discomfort and flatulence.

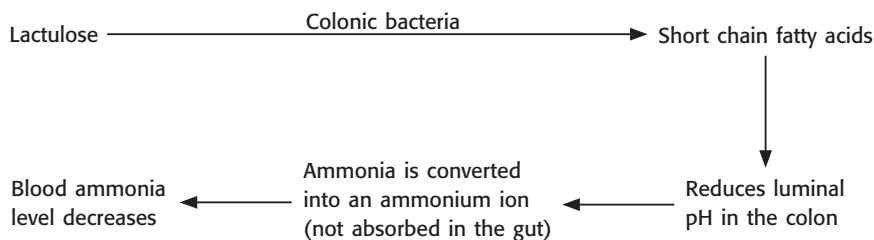

Fig. 8.3 Action of lactulose in hepatic coma.

Uses of laxatives with preparation of choice

1. Acute functional constipation (atonic or spastic)—bulk laxatives.
2. To avoid straining during defaecation in patients with cardiovascular disease, eye surgery, hernia, etc.—docusates or bulk laxatives.
3. In patients with hepatic coma to reduce the blood ammonia level—lactulose.
4. Preoperatively in bowel surgery, colonoscopy and abdominal X-ray—osmotic laxatives or bisacodyl.
5. Following certain anthelmintics (e.g. for *Taenia solium*)—osmotic laxatives to expel the worm segments.
6. In drug poisoning to wash out the poisonous material from the gut—osmotic laxatives.
7. To treat constipation in children and pregnant women—lactulose.

Key Points for Dentists

- Purgatives should not be given to patients with acute abdominal pain before diagnosis is made.
- Bulk laxatives should be taken with plenty of water.
- Stimulant laxatives should be avoided during pregnancy.

PHARMACOTHERAPY OF PEPTIC ULCER AND GASTROESOPHAGEAL REFLUX DISEASE

Physiology of gastric secretion

The stomach secretes roughly about 2–3 L of gastric juice/day. The chief or peptic cells secrete pepsinogen, which is converted to pepsin by gastric acid. Parietal or oxyntic cells secrete acid and intrinsic factor (IF). Superficial epithelial cells secrete alkaline mucus and bicarbonate ions.

Regulation of gastric acid secretion

The secretion of gastric acid by parietal cells is regulated by ACh, histamine, gastrin and prostaglandin E_2 (PGE_2). Binding of histamine, ACh and gastrin to their specific receptors on the parietal cell results in increased secretion of gastric acid. In contrast, the binding of PGE_2 to its receptor decreases gastric acid secretion. There are various phases of gastric acid secretion—basal, cephalic and hormonal. A membrane-bound proton pump H^+ , K^+ -ATPase plays an important role in the final step of gastric acid secretion.

Damage to the mucosa and deeper tissue exposed to acid and pepsin is known as peptic ulcer. The exact cause of peptic ulcer is not clear. In most of the cases, peptic ulcers are caused by *Helicobacter pylori* infection or the use of nonsteroidal antiinflammatory drugs (NSAIDs).

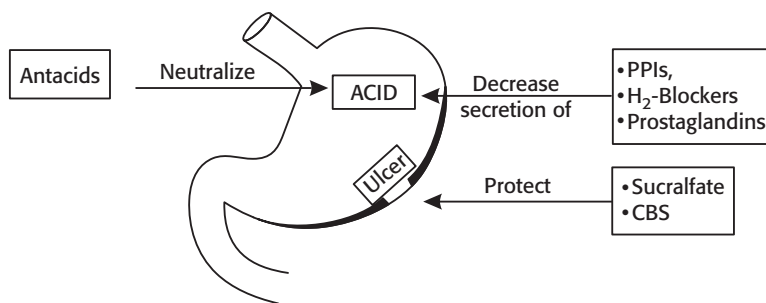

Fig. 8.4 Drugs used in peptic ulcer; PPIs, proton pump inhibitors; CBS, colloidal bismuth subcitrate.

Classification of drugs used in peptic ulcer (Fig. 8.4)

1. **Drugs that inhibit gastric acid secretion**

- a. *Proton-pump inhibitors (PPIs)*: Omeprazole, esomeprazole, lansoprazole, pantoprazole, rabeprazole.
- b. *H₂-receptor antagonists (H₂-blockers)*: Cimetidine, ranitidine, famotidine, roxatidine.
- c. *Antimuscarinic agents (Anticholinergic agents)*: Pirenzepine, telenzepine.
- d. *Prostaglandin analogues*: Misoprostol.

2. **Ulcer protectives**

Sucralfate, colloidal bismuth subcitrate (CBS).

3. **Drugs that neutralize gastric acid (antacids)**

- a. *Systemic antacids*: Sodium bicarbonate, sodium citrate.
- b. *Non-systemic antacids*: Magnesium hydroxide, magnesium trisilicate, aluminum hydroxide, calcium carbonate.

4. **Anti-*H. pylori* drugs**

Amoxicillin, tetracycline, clarithromycin, metronidazole, tinidazole, bismuth subsalicylate, H₂-antagonists and proton pump inhibitors.

■ Drugs That Inhibit Gastric Acid Secretion

● Proton Pump Inhibitors (PPIs)

Proton pump H⁺, K⁺-ATPase is a membrane-bound enzyme that plays an important role in the final step of gastric acid secretion (basal and stimulated; Fig. 8.5). Omeprazole is the prototype drug. The other PPIs are lansoprazole, pantoprazole and rabeprazole. They are prodrugs and are activated to sulfenamide at acidic pH. As PPIs act in the final step of acid secretion, they are effective in inhibiting acid production following any stimulation. The activated form binds covalently with SH group of the proton pump and irreversibly inactivates it. PPIs are the most powerful inhibitors of gastric acid secretion. They are administered orally about 30 min before food because food stimulates secretion of acid (in the canaliculi of parietal cell), which is necessary for activation of PPIs. Though the half-life of PPIs is short (~ 1.5 h), acid secretion is suppressed for up to 24 h as they cause irreversible inhibition of proton pumps. In the commonly used doses, PPIs suppress acid production by about 80–95%. PPIs are available as enteric-coated form or as powder containing sodium bicarbonate to prevent

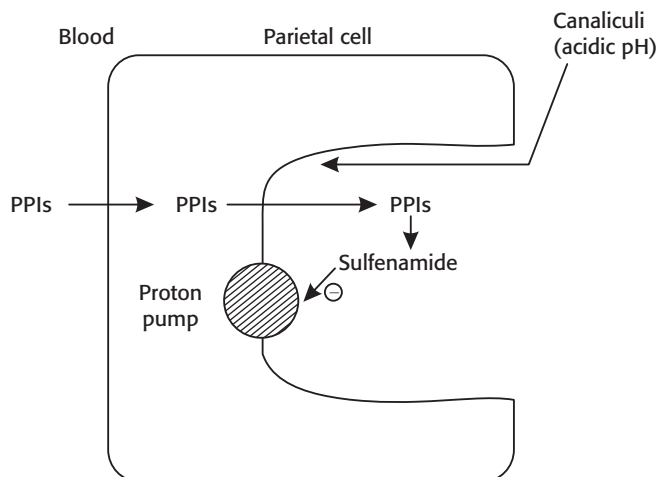

Fig. 8.5 Mechanism of action of proton pump inhibitors.

their degradation by acid in the stomach. Parenteral (i.v.) formulations are available for esomeprazole, lansoprazole, pantoprazole and rabeprazole. They are highly bound to plasma proteins; extensively metabolized in liver and their metabolites are excreted in urine.

Therapeutic uses

1. **Peptic ulcer:** PPIs are the most powerful acid suppressive agents. They inhibit all phases of gastric acid secretion. PPIs are superior to H_2 -blockers as their onset of action is rapid and cause faster ulcer healing. The standard dose of omeprazole is 20 mg and lansoprazole is 30 mg once daily. *Duodenal ulcers* require 4-weeks therapy and *gastric ulcers* require 6–8-weeks therapy for healing.
 - *In acute bleeding ulcers*, intravenous PPIs are preferred. By suppressing acid secretion, they promote healing of ulcer.
 - *H. pylori-associated ulcers:* Combination therapy of two or three antibiotics and a PPI is the most effective regimen for these ulcers.
 - *Stress ulcers (Curling ulcer):* Prophylactic use of oral omeprazole /intravenous PPIs reduces the incidence of stress ulcers in critically ill patients.
 - *NSAID-induced ulcers:* PPIs are more effective than H_2 -blockers in the prevention and treatment of NSAID-induced ulcers.
2. **Gastroesophageal reflux disease (GERD):** In GERD, the goal of therapy is to produce symptom relief, heal erosive oesophagitis and prevent complications. Proton pump inhibitors are the drug of choice for the treatment of GERD and are usually given once daily. They are more effective than H_2 -blockers. Patients with erosive oesophagitis or peptic ulcer with stricture need prolonged maintenance therapy with PPIs.
3. **Zollinger–Ellison syndrome (Z–E syndrome):** Zollinger–Ellison syndrome is characterized by hypergastrinaemia with multiple peptic ulcers. Proton pump inhibitors are the drugs of choice for Z–E syndrome. Higher doses of PPIs are needed for healing of ulcers. Surgery is the definitive treatment. In inoperable cases, prolonged therapy with PPIs has been recommended.

Adverse effects

Proton pump inhibitors are generally well tolerated. The side effects are headache, diarrhoea and abdominal pain. Skin rashes and arthralgia can rarely occur. Long-term use of PPIs can decrease vitamin

B₁₂ absorption, increase the risk of infections (e.g. hospital acquired pneumonia) and fracture of bones. Chronic use also results in hypergastrinaemia, which may predispose to gastric tumours.

Drug interactions

- Omeprazole can inhibit the metabolism of drugs like phenytoin, warfarin, diazepam, etc.
- Proton pump inhibitors decrease the bioavailability of itraconazole, iron salts, etc.

H₂-Receptor Antagonists (H₂-Blockers)

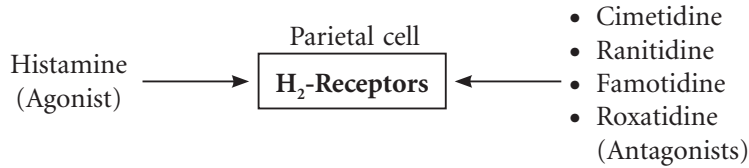

Mechanism of action

H₂-receptor antagonists competitively block H₂-receptors on parietal cell and inhibit gastric acid production. They suppress all phases (basal, cephalic and gastric) of acid secretion. They are mainly effective in suppressing nocturnal acid secretion. H₂-blockers also reduce acid secretion stimulated by ACh, gastrin, food, etc. They are less potent than PPIs—24 h acid secretion is suppressed by 60–70%. Cimetidine is the prototype drug and was the first H₂-blocker to be used in clinical practice. It is seldom used now because of its adverse effects (Table 8.2).

Table 8.2 Comparison of Cimetidine and Ranitidine

Cimetidine	Ranitidine
1. H ₂ -blocker (competitive blocker)	H ₂ -blocker (competitive blocker)
2. Less potent	More potent
3. Has shorter duration of action (6–8 h)	Has longer duration of action (24 h)
4. Cimetidine is an enzyme inhibitor, hence increases the plasma concentration of many co-administered drugs, such as phenytoin, digoxin, theophylline, warfarin, propranolol, etc.	Has less affinity for hepatic CYPs; hence drug interactions are rare.
5. Has antiandrogenic effect, hence can cause menstrual irregularities and galactorrhoea in women and gynaecomastia, oligospermia and impotence in men	Has no antiandrogenic effect
6. Crosses BBB and produces CNS side effects like confusion, headache, hallucinations, etc., especially in elderly patients	Poorly crosses BBB, hence CNS side effects are rare

H₂-blockers are usually administered orally and are well absorbed; metabolized in liver and the metabolites are excreted in urine. Cimetidine, ranitidine and famotidine are also available for intravenous administration.

- **Famotidine:** Most of the features are similar to ranitidine. It is more potent than ranitidine and has a longer duration of action. It has no antiandrogenic effect. Drug interactions with famotidine are negligible.

Therapeutic uses

1. **Peptic ulcer disease:** H₂-blockers are one of the commonly used drugs in peptic ulcer. H₂-blockers produce symptomatic relief within days and ulcer healing within weeks. The duration of treatment for duodenal ulcer is 4–6 weeks. Gastric ulcer requires prolonged therapy of up to 6–8 weeks.
 - *H. pylori-associated ulcers:* H₂-blockers can be used along with antimicrobial agents to treat *H. pylori* infection.
 - *Stress ulcers* are commonly seen in critically ill patients with severe medical or surgical illness. They may be associated with upper gastrointestinal bleeding. Intravenous H₂-blockers are used to prevent and treat stress-related ulcer and bleeding.
 - *NSAID-induced ulcers:* H₂-blockers can be used for healing of NSAID-induced ulcers, but they are less effective than PPIs.
2. **Zollinger–Ellison syndrome:** In Z–E syndrome, surgery is the definitive therapy. PPIs or H₂-blockers are used to control the hypersecretion of acid. PPIs are the drug of choice in Z–E syndrome.
3. **Gastroesophageal reflux disease:** In GERD, H₂-blockers are effective and produce symptomatic relief. PPIs are more effective than H₂-blockers; hence PPIs are more commonly used.
4. **H₂-blockers are used preoperatively** before emergency surgery to reduce the risk of aspiration pneumonia.

Anticholinergic Agents

Pirenzepine and telenzepine, selective M₁-receptor blockers, inhibit acid secretion. They are not commonly used because of their low efficacy and anticholinergic side effects.

Prostaglandin Analogues

Misoprostol, a synthetic PG analogue (PGE₁), is effective orally for the prevention and treatment of NSAID-induced gastric and duodenal ulcers. It inhibits gastric acid secretion, and increases mucus and bicarbonate secretion; it also increases mucosal blood flow, thus producing cytoprotective effect. Its common side effects are diarrhoea and abdominal cramps. Misoprostol is contraindicated in pregnancy, as it may cause uterine contractions. Because of its adverse effects and need for frequent dosing, it is rarely used.

Ulcer Protectives

Sucralfate

It is a complex of aluminium hydroxide and sulphated sucrose. In the acidic environment of the stomach (pH <4), sucralfate undergoes polymerization to form a sticky gel that adheres to the ulcer base and protects it. It also precipitates proteins at the ulcer base—forms a barrier against acid–pepsin. It stimulates the release of PGs and epidermal growth factor locally, thus produces cytoprotective effect. It also increases mucus and bicarbonate secretion and enhances mucosal defence and repair.

Sucralfate is given orally on an empty stomach at least 1 h before meals. It reduces the absorption of drugs such as digoxin, tetracyclines, ketoconazole, fluoroquinolones, etc. Since it requires pH <4 for activation, concurrent administration of antacids, H₂-blockers or PPIs should be avoided. Constipation is a common side effect. Nausea may occur. Aluminium toxicity can occur in patients with renal failure.

After the introduction of PPIs, sucralfate is seldom used in peptic ulcer. Sucralfate is effective for the prevention of bleeding from stress ulcers and to reduce the risk of aspiration pneumonia. It is also

useful in GERD with oesophagitis, as it serves as a mucosal protector. Other uses are oral mucositis, radiation proctitis, rectal ulcer, burns, bed sores, etc.

■ Bismuth-containing Preparations

Bismuth subsalicylate and colloidal bismuth subcitrate (CBS) are the most commonly used oral bismuth preparations. Their mode of action is not clear. They probably:

1. React with protein in the base of the ulcer and protect it from peptic digestion.
2. Stimulate the secretion of PGE₂, mucus and bicarbonate.
3. Have antimicrobial effect against *H. pylori*.

They are one of the components in certain anti-*H. pylori* regimens. The side effects are blackening of the tongue and stools.

■ Drugs That Neutralize Gastric Acid (Antacids)

Antacids are weak bases that neutralize gastric acid and thus raise the gastric pH. They do not affect acid production.

An ideal antacid:

- should be insoluble and capable of neutralizing acid.
- should not liberate CO₂.
- should be nonabsorbable.
- should not disturb the acid–base balance of the body.

Types of antacids

1. *Systemic*: Sodium bicarbonate and sodium citrate.
2. *Nonsystemic*: Magnesium hydroxide, magnesium trisilicate, aluminum hydroxide gel and calcium carbonate.

Systemic antacids

Sodium bicarbonate (NaHCO₃): It is very effective and rapidly neutralizes gastric acid, but the duration of action is short. The disadvantages of NaHCO₃ are that: (i) it is highly water soluble and rapidly absorbed from the gut; (ii) it releases CO₂ that can cause abdominal distension and belching; (iii) it may cause metabolic alkalosis; and (iv) it produces rebound acidity.

Sodium bicarbonate is also used to alkalinize urine and to treat acidosis. It should be avoided in patients with hypertension and congestive cardiac failure, as it causes sodium retention.

Nonsystemic antacids

Magnesium hydroxide, magnesium trisilicate, aluminium hydroxide, calcium carbonate, etc. form respective chloride salts in stomach. When this reaches the intestine, the chloride salt reacts with bicarbonate, so HCO₃⁻ is not available for absorption, hence, there is no systemic alkalosis.

Combination of antacids produces various beneficial effects. They are:

1. Aluminum salts cause constipation and magnesium salts cause diarrhoea; so combination of these two can counteract the adverse effects of each other.
2. Magnesium hydroxide has a rapid onset of action, but aluminum hydroxide acts slowly—the combined product produces rapid and sustained effect.
3. Dose of individual antacid is reduced; hence systemic toxicity is minimized.

Formulations: Antacids are available as suspension, tablet and powder. Tablet should be chewed and swallowed for better effect. Suspensions have better neutralizing capacity than other formulations.

Adverse effects of antacids

1. Sodium bicarbonate can cause systemic alkalosis and sodium overload.
2. Magnesium hydroxide may produce diarrhoea.
3. Aluminum hydroxide may produce constipation and phosphate depletion.
4. Calcium carbonate may produce hypercalcaemia and hypercalciuria.
5. Acid rebound can occur.

Drug interactions

All antacids increase the pH of stomach and form insoluble and nonabsorbable complexes with many drugs—iron, tetracyclines, fluoroquinolones, ketoconazole, etc.; thus antacids reduce the absorption of these drugs. There should be a gap of 2 h between administration of these drugs and antacids.

■ Antifoaming Agents

- **Methylpolysiloxane (simethicone and dimethicone):** They are antifoaming agents, usually present in some antacid preparations. They decrease foaming and relieve flatulence.
- **Oxethazaine:** It is a topical anaesthetic and is used to anaesthetize gastric mucosa. It produces symptomatic relief in gastritis and GERD. It is available in combination with antacids.
- **Sodium alginate:** It forms froth on the contents in the stomach—prevents effects of gastroesophageal reflux.

■ Anti-*Helicobacter pylori* Agents

Helicobacter pylori, a gram-negative, rod-shaped bacteria, is associated with gastritis, duodenal ulcer, gastric ulcer and gastric carcinoma (Fig. 8.6).

The mechanism by which *H. pylori* causes mucosal inflammation and damage is not clear. The ammonia produced by urease activity may directly damage the cells.

Many regimens are available for the eradication of *H. pylori*. Combination therapy (triple/quadruple) is always recommended. The objectives of combination therapy are:

1. To prevent or delay the development of resistant organism.

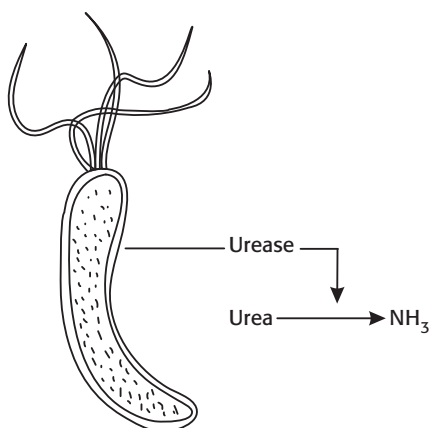

Fig. 8.6 *Helicobacter pylori*.

2. To prevent relapse.
3. To promote rapid ulcer healing.
4. To eradicate *H. pylori* infection.

The duration of treatment could be for 1 week or 2 weeks, of which 2-weeks' therapy is more effective.

The antimicrobials used in *H. pylori* infection are amoxicillin, tetracycline, clarithromycin, metronidazole and tinidazole. Resistance develops rapidly to metronidazole and clarithromycin, but not to amoxicillin or tetracycline. Amoxicillin should be avoided in patients with history of penicillin allergy. Other anti-*H. pylori* drugs are PPIs, H₂-blockers and CBS. Some of the recommended regimens are listed below:

Triple therapy × 14 days (2 weeks)

- Lansoprazole 30 mg BD +
- Clarithromycin 500 mg BD +
- Amoxicillin 1 g BD.

Quadruple therapy × 14 days (2 weeks)

- Lansoprazole 30 mg BD +
- Bismuth subsalicylate 525 mg QID +
- Tetracycline 500 mg QID +
- Metronidazole 500 mg TID.

After completion of the above regimen, proton pump inhibitor should be continued for six more weeks to enhance ulcer healing.

Key Points for Dentists

- Sodium bicarbonate is one of the components of dentifrices. It neutralizes the acid formed following the action of bacteria on food lodged in between the teeth.
- Antacid containing magnesium and aluminium should be given cautiously to patients with renal failure.
- Antacids should not be used along with sucralfate and PPIs, as antacids reduce their effect.
- Antacids should not be used with iron and tetracyclines, as antacids reduce their absorption.
- Intravenous omeprazole, lansoprazole, ranitidine, etc. are used in bleeding peptic ulcer.
- Shake antacid suspension well before use.
- Antacid tablets should be properly chewed and swallowed.
- Proton pump inhibitors should be taken ½ h before food.
- The preferred analgesic for patients with peptic ulcer is paracetamol or selective COX-2 inhibitors.
- Glucocorticoids and NSAIDs should be avoided in patients with peptic ulcer, as they may aggravate the condition.

This page intentionally left blank

Drugs Acting on Blood and Blood-forming Organs

9

DRUGS AFFECTING COAGULATION AND BLEEDING

■ Haemostatic Agents

They arrest bleeding either by vasoconstriction or by promoting coagulation of blood.

Classification

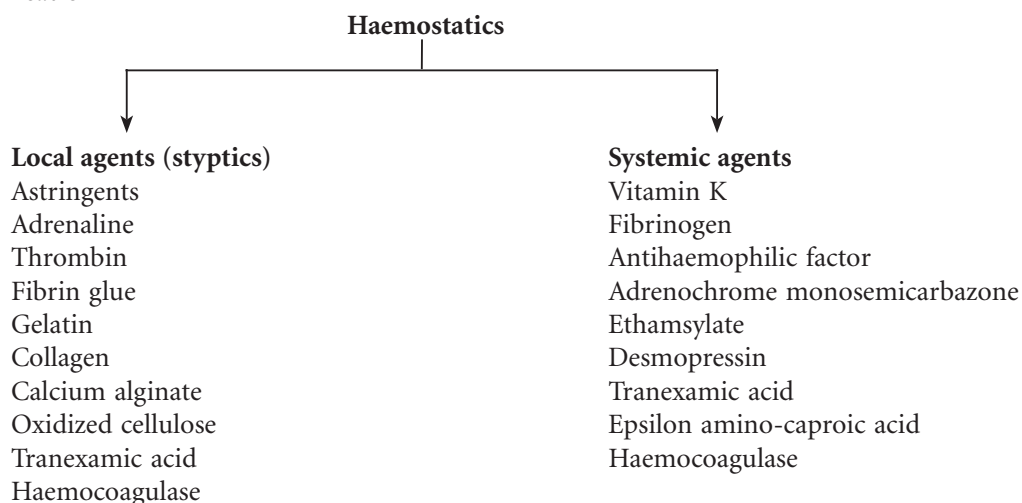

■ Local Haemostatics (Styptics)

These drugs are commonly used to control bleeding from capillaries and minute vessels, e.g. bleeding following tooth extraction, abrasions, epistaxis, etc.

Astringents: They precipitate proteins locally in the bleeding site and control capillary oozing, e.g. tannic acid, ferric chloride, ferric sulfate, aluminum chloride, aluminum sulfate, etc.

Adrenaline: It causes vasoconstriction (α_1) and arrests bleeding. A cotton pad soaked in 0.1% adrenaline solution is applied on the bleeding site to control capillary oozing, e.g., epistaxis, bleeding after tooth extraction or from other sites. Adrenaline should be avoided in patients with hypertension, congestive cardiac failure, arrhythmias, ischaemic heart disease and uncontrolled hyperthyroidism as it may precipitate myocardial infarction (MI) or aggravate the existing condition.

Thrombin: It converts fibrinogen to fibrin, thus facilitating the last step in the coagulation cascade and promoting haemostasis. Bovine plasma-derived thrombin, human plasma-derived thrombin and recombinant thrombin are available. Hypersensitivity reactions can occur to bovine thrombin. Human plasma-derived thrombin carries the risk of virus transmission. Immunogenic reactions are rare with recombinant thrombin. Thrombin is placed in the tooth socket to arrest bleeding.

Fibrin glue: It consists of fibrinogen, factor XIII, thrombin, Ca^{2+} and other clotting components. It is used to control bleeding during surgical procedures or as a spray on the bleeding surface. Fibrin sealant in combination with tranexamic acid mouthwash helps to reduce bleeding during dental extraction in haemophilic patients. Fibrin sealants made from human plasma carry the risk of transmitting viral infections.

Collagen: It controls bleeding by promoting aggregation of platelets and accelerating coagulation. Collagen sponges are placed in tooth socket following extraction to arrest bleeding.

Gelatin: It is a protein and is used as a haemostatic in surgical procedures. It is an absorbable haemostatic and is available as a sponge or a film. It produces haemostasis by providing a physical meshwork on which clotting can occur. Adverse effects are infection, granuloma formation and fibrosis.

Oxidized cellulose: It is an absorbable haemostatic. It should be applied dry so that it swells up and helps in the formation of a clot. It is used to control bleeding from capillaries and arterioles where ligation is not possible. It may cause tissue necrosis, nerve damage or vascular stenosis.

Calcium alginate: It is obtained from sea weeds. It is an absorbable haemostatic and is used to promote wound healing.

Haemocoagulase: Haemocoagulase enzyme complex is isolated from the venom of *Bothrops atrox* (viper).

Mechanism of action

It has a powerful haemostatic effect. It promotes coagulation by two enzymes: one that has thrombin-like action (converts fibrinogen to fibrin) and another that has thromboplastin-like action. It can also shorten the bleeding and clotting time; thereby it controls capillary bleeding.

Pharmacokinetics

It is available for topical, intravenous, intramuscular and subcutaneous administration. It has a rapid onset of action—within 5–10 min of i.v.; 20–30 min after i.m. administration and within a minute of topical application (spray/soaked swab).

Indications

- To control bleeding following tooth extraction or any other dental procedure.
 - For prevention and treatment of haemorrhagic conditions of different etiology.
- Adverse effects* are rare; they may cause anaphylactic reaction on intravenous administration.

Tranexamic acid: See p. 251.

Systemic Agents

Vitamin K

Vitamin K, a fat-soluble vitamin, is required for the synthesis of clotting factors. It exists in different forms: vitamin K_1 (phytonadione) is from plant and animal source; vitamin K_2 (menaquinone) is produced by intestinal bacteria and is stored in hepatic tissue, whereas vitamin K_3 (menadione) is a synthetic form. All three forms of vitamin K (K_1 , K_2 and K_3) are naphthoquinone derivatives.

Dietary source: Vitamin K is found in spinach, cabbage, cauliflower and tomatoes. It is also present in butter, meat, milk, liver and pears. The average daily intake for an adult is estimated to be 70–140 mcg/day.

Pharmacokinetics: Vitamin K₁ and K₂ require the presence of bile for their absorption, while water-soluble forms can be absorbed in the absence of bile. Vitamin K is transported along with low-density lipoprotein (LDL) and is stored mainly in the liver. It is metabolized by glucuronide and sulphate conjugation; metabolites are excreted in bile and urine.

Actions: Vitamin K acts as a cofactor for γ -carboxylation of glutamic acid residues of clotting factors (II, VII, IX and X).

Deficiency: Vitamin K deficiency may occur due to inadequate absorption (lack of bile salts), loss of vitamin (chronic diarrhoea) and administration of broad-spectrum antibiotics (suppression of bacterial flora). In vitamin K deficiency, there is an increased tendency to bleed—epistaxis, haematuria, gastrointestinal bleeding and post-operative bleeding.

Preparations

- *Phytonadione (vitamin K₁):* It is available for oral, subcutaneous (s.c.), intramuscular (i.m.) and intravenous (i.v.) administration.
- *Menadiol sodium diphosphate (vitamin K₃):* It is a water-soluble preparation and is available for i.v., i.m. and oral administration.

Uses

1. For prevention and treatment of bleeding associated with vitamin K deficiency.
2. In obstructive jaundice with haemorrhagic symptoms, parenteral vitamin K₁ is preferred.
3. Vitamin K₁ (1 mg phytonadione, i.m.) is given routinely to all neonates to prevent bleeding, as the intestinal flora—which is necessary for the synthesis of vitamin K—is not developed.
4. To control bleeding due to oral anticoagulant therapy, phytonadione is used.
5. Vitamin K₁ is used in salicylate poisoning with haemorrhagic complications.

Adverse effects: Oral vitamin K is safe. Intravenous injection may cause flushing, sweating, dyspnoea, hypotension, cyanosis, collapse and anaphylactic reaction. Administration of vitamin K through intramuscular and s.c. routes may cause severe pain and bleeding at the site of injection. Menadione may cause haemolysis, hyperbilirubinaemia and kernicterus in newborn, hence is not used.

Fibrinogen

It is obtained from human plasma. It is used to control bleeding associated with hypofibrinogenaemia and is infused intravenously.

Antihaemophilic factor

It contains coagulation factor VIII with von Willebrand's factor. It is used to control bleeding episodes in haemophiliacs. It is administered as i.v. infusion. Adverse effects include fever with chills, headache and skin rashes.

Adrenochrome monosemicarbazone

It is an oxidation product of adrenaline. It is available for oral and parenteral administration. It is used to control capillary oozing following tooth extraction, epistaxis, etc.

Ethamsylate

It is a haemostatic, available for oral, i.m. and i.v. administration. It corrects abnormal platelet adhesion and also maintains the stability of the capillary wall. It is well absorbed after oral administration, secreted

in breast milk and excreted unchanged in urine. It is used for prophylaxis and to control bleeding from small blood vessels, e.g. following tooth extraction, epistaxis, etc. It may cause skin rashes, hypotension and headache.

Desmopressin

It is a synthetic analogue of vasopressin. It is used to control mild-to-moderate bleeding in haemophilia A and von Willebrand's disease. It is infused intravenously slowly.

Tranexamic acid and epsilon amino-caproic acid

See p. 250–251.

■ Anticoagulants

Anticoagulants are drugs that prevent or reduce coagulability of blood.

Classification

1. *Used in vitro*:

- a. Heparin
 - b. Sodium citrate: Used in blood banks to store blood.
 - c. Sodium oxalate
 - d. Sodium edetate
- } Used as an anticoagulant in laboratory

2. *Used in vivo*:

- a. *Parenteral anticoagulants*
 - i. Heparin [unfractionated heparin (UFH)].
 - ii. Low-molecular-weight heparins (LMWHs): Enoxaparin, dalteparin, tinzaparin, ardeparin, reviparin.
 - iii. Fondaparinux.
 - iv. Direct thrombin inhibitors: Lepirudin, bivalirudin.
- b. *Oral anticoagulants*
 - i. Coumarin derivatives: Warfarin, dicumarol.
 - ii. Indandione derivatives: Phenindione.
 - iii. Oral direct thrombin inhibitor: Dabigatran etexilate.

■ Parenteral Anticoagulants

Heparin (Unfractionated Heparin [UFH]; Table 9.1)

Heparin was discovered by a medical student, McLean. It was later isolated and identified by Howell as a sulphated mucopolysaccharide. Because of its high concentration in liver, it was named heparin. A strong electronegative compound, it is the strongest organic acid in the body. Commercially, heparin is obtained from ox lung and pig intestinal mucosa.

Mechanism of action (Fig. 9.1)

Heparin is an indirect thrombin inhibitor. Heparin binds and accelerates the activity of plasma antithrombin III. Heparin antithrombin III complex then inhibits activated clotting factors Xa, IIa, IXa, XIa, XIIa and XIIIa by forming stable complexes with them. At low concentration, heparin selectively inhibits the conversion of prothrombin to thrombin. Heparin thus prevents further thrombus formation. Heparin in high doses has antiplatelet action and, thereby, prolongs the bleeding time. Heparin reduces the blood lipid level by releasing lipoprotein lipase from vessel wall and tissues.

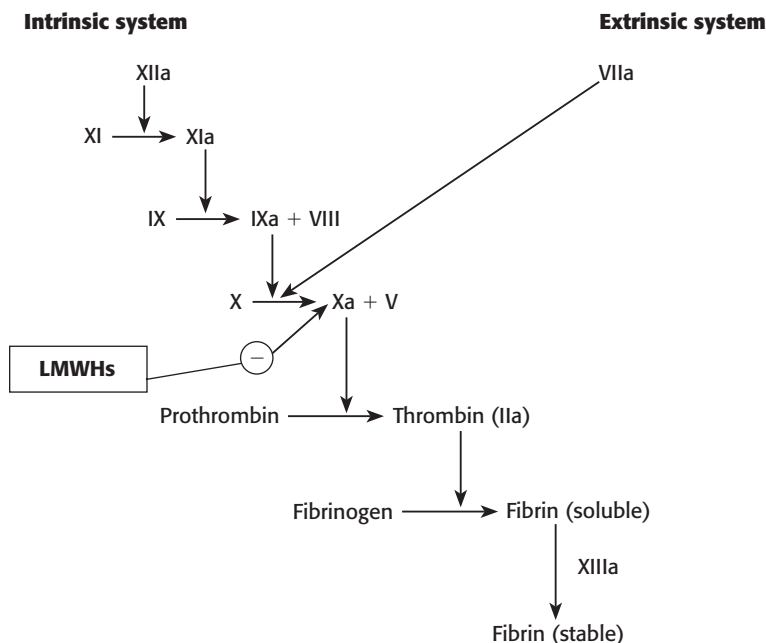

Fig. 9.1 The coagulation cascade. Heparin inactivates factor XIIa, XIa, IXa, Xa, IIa and XIIIa through antithrombin. LMWHs inhibit Xa through antithrombin.

Pharmacokinetics

Heparin is not absorbed after oral administration because of its high negative charge and large molecular size. Therefore, it must be given parenterally—intravenously or subcutaneously. On i.v. administration, the anticoagulant effect starts immediately, whereas through s.c. route, it takes 1–2 hours. Heparin is highly protein bound. It does not cross the blood–brain barrier or placental barrier and is safe during pregnancy. It is rapidly inactivated in the liver by heparinase and the metabolites are excreted in urine.

Mode of administration

Heparin is administered by i.v. infusion and i.v. intermittent injection (for treatment) or s.c. route (for prophylaxis). Administration of heparin intramuscularly may cause haematomas; hence, this route should not be used. During heparin therapy, activated partial thromboplastin time (aPTT) monitoring is necessary, and it should be maintained at 1.5–2.5 times the control.

Adverse effects and contraindications

1. **Bleeding:** Heparin has a narrow therapeutic dose range—bleeding is the main side effect. Overdosage may cause serious and fatal haemorrhage. Bleeding can occur in the urinary and gastrointestinal tract or anywhere in the body. Hence, heparin therapy requires aPTT monitoring. If life-threatening haemorrhage occurs, it can be controlled rapidly by slow i.v. infusion of protamine sulphate (heparin antagonist). It is a strongly basic protein and hence rapidly neutralizes the anticoagulant effect of heparin.

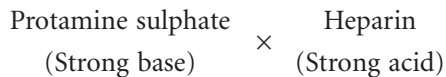

Protamine sulphate is a specific heparin antagonist, which is obtained from fish sperm. One milligram of protamine sulphate approximately neutralizes 100 units of heparin (chemical antagonism). Protamine sulphate itself may cause bleeding as it has weak anticoagulant effect. Hence, the maximum dose must not exceed 50 mg.

2. *Heparin-induced thrombocytopenia (HIT)*: Heparin rarely causes thrombocytopenia, but it is a dangerous complication. The incidence is higher with unfractionated heparin (UFH) than with LMWHs.
3. *Hypersensitivity reactions* can occur rarely. They are skin rashes, urticaria, fever, etc.
4. *Osteoporosis*: Dose-dependent osteoporosis with spontaneous fractures may occur during long-term therapy.
5. *Reversible alopecia* has been reported.

Heparin is contraindicated in haemophiliacs, patients with heparin-induced thrombocytopenia (HIT), severe hypertension, intracranial haemorrhage, bacterial endocarditis, active tuberculosis, peptic ulcer, threatened abortion, cirrhosis, renal failure, etc.

Low-molecular-weight heparins (LMWHs)

Enoxaparin, dalteparin, tinzaparin, ardeparin, reviparin, etc. are LMWHs and are isolated from standard heparin by various techniques. LMWHs are indirect thrombin inhibitors—produce anticoagulant effect mainly by inhibition of factor Xa through antithrombin. LMWH therapy usually does not require aPTT monitoring, but patients with chronic renal failure may need monitoring by measuring factor Xa activity. Low-molecular-weight heparins are given subcutaneously. The following are the advantages of LMWHs:

1. They have a higher s.c. bioavailability as compared to UFH.
2. They have a longer duration of action.
3. They do not routinely require aPTT monitoring.
4. There is a lower incidence of thrombocytopenia and osteoporosis.

(Uses, adverse effects and contraindications are same as other anticoagulants)

Fondaparinux

It is a synthetic parenteral anticoagulant. It binds to antithrombin and selectively inhibits factor Xa (indirect thrombin inhibitor). It does not require routine laboratory monitoring. Fondaparinux is administered subcutaneously. It is useful in pulmonary embolism and deep vein thrombosis (DVT). Incidence of thrombocytopenia is lower with fondaparinux.

Direct thrombin inhibitors

Lepirudin and bivalirudin combine directly and inactivate thrombin without binding to antithrombin III. They are used in patients who are at risk of heparin induced thrombocytopenia.

Oral Anticoagulants (Table 9.1)

Among oral anticoagulants, coumarin derivatives are commonly used. Oral anticoagulants act only *in vivo*. They are vitamin K antagonists.

Table 9.1 Differences Between Heparin (Parenteral Anticoagulant) and Warfarin (Oral Anticoagulant)

Heparin	Warfarin
1. Naturally occurring: animal source—ox lung, pig intestine	Synthetic
2. Active <i>in vivo</i> and <i>in vitro</i>	Active only <i>in vivo</i>
3. Administered parenterally (i.v., s.c.)	Administered orally
4. Acts by activating antithrombin III and inactivates Xa, IIa, IXa, XIa, XIIa and XIIIa	Acts by inhibiting synthesis and carboxylation of vitamin K-dependent clotting factors II, VII, IX and X
5. Has a rapid onset, but short duration of action (3–6 h)	Has a delayed onset, but long duration of action (3–6 days)
6. Heparin therapy is monitored by measuring aPTT	Therapy is monitored by measuring INR
7. Overdosage is treated with protamine sulphate (antagonist)	Overdosage is treated with fresh frozen plasma and vitamin K ₁
8. Does not cross the placental barrier and is safe during pregnancy	Crosses the placental barrier and has teratogenic potential
9. Used mainly to initiate therapy	Used for maintenance therapy
10. Expensive	Not expensive

Mechanism of action (Fig. 9.2)

Clotting factors II, VII, IX and X are synthesized in liver as inactive proteins. These factors are rich in glutamic acid residues and are carboxylated in liver where active form of vitamin K acts as a cofactor. Vitamin K is converted to inactive epoxide form by oxidation and is regenerated to its active form by epoxide reductase enzyme. Warfarin is a coumarin derivative and has a structure similar to that of vitamin K. Hence, warfarin competitively inhibits epoxide reductase enzyme, thus inhibiting the synthesis of vitamin K-dependent biologically active factors—II, VII, IX and X and produces anticoagulant

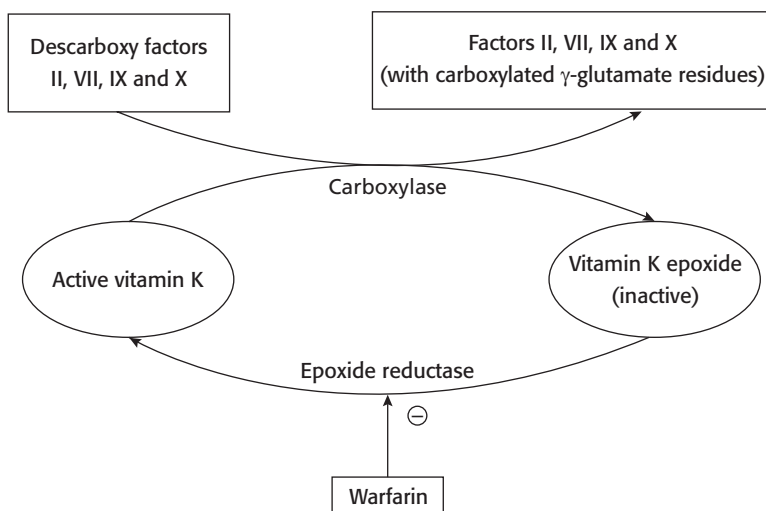
**Fig. 9.2** The role of vitamin K in clotting and the mechanism of action of warfarin.

effect. The onset and duration of anticoagulant effect of warfarin depends on the half-lives (in hours) of clotting factors, which are as follows: VII (6), IX (24), X (36) and II (50). There is always a delay in the onset of anticoagulant effect because the levels of clotting factors already present in plasma decline slowly over a period of 1–3 days.

Pharmacokinetics

Warfarin is almost completely absorbed after oral administration. It can also be given intravenously or rectally. Food interferes with the absorption of warfarin. It is highly bound to plasma proteins, freely crosses placental barrier, is metabolized in liver and the inactive metabolites are excreted in urine and stool. It has a long half-life of about 40 hours, and the duration of action is 2–5 days.

Adverse effects

1. **Bleeding:** Bleeding is the most important and common side effect of warfarin. Bleeding can occur anywhere—skin, pulmonary, gastrointestinal and urinary tract, cerebral, hepatic, uterine, etc. Bleeding can be controlled by oral or parenteral vitamin K₁ (depending on severity). Fresh frozen plasma should be given in severe bleeding. Oral anticoagulant therapy is monitored by measuring international normalized ratio (INR).

$$\text{INR} = \left\{ \frac{\text{PT}_{\text{pt}}}{\text{PT}_{\text{ref}}} \right\}^{\text{ISI}}$$

INR = International normalized ratio.
 PT_{pt} = Prothrombin time of patient.
 PT_{ref} = Prothrombin time of reference sample.
 ISI = International sensitivity index.

Prothrombin time measured has been standardized internationally by each laboratory calibrating its own thromboplastin against the standard one.

In patients on oral anticoagulants, with a stable INR <4, the risk of significant bleeding is low following a dental procedure. Oral anticoagulants should not be discontinued in a majority of such patients requiring outpatient dental treatment as it increases the risk of thrombosis. Adequate haemostasis can be obtained in such patients by gelatin, oxidised cellulose, fibrin, collagen sponges or tranexamic acid mouthwash without discontinuation of anticoagulants.

2. **Teratogenic effect:** Warfarin is contraindicated during pregnancy as it may cause foetal CNS abnormalities, foetal haemorrhage, abortion or intrauterine death.
3. **Skin necrosis:** It is a rare complication that occurs within the first week of therapy. The skin lesions are commonly seen on breast, buttocks, abdomen and thighs.
4. **Other rare side effects:** These include diarrhoea, alopecia, urticaria, dermatitis, abdominal cramps and anorexia.

Drug interactions

1. **Oral anticoagulants × barbiturates/carbamazepine/rifampicin/griseofulvin:** They are enzyme inducers, increase metabolic clearance of oral anticoagulants and hence decrease the anticoagulant effect.
2. **Warfarin × salicylates/sulphonamides:** Warfarin is highly protein bound. These drugs displace warfarin from plasma protein binding site, increase the free plasma concentration of warfarin, which can result in bleeding.
3. **Warfarin × alcohol/chloramphenicol/isoniazid/imidazoles/disulfiram:** They are enzyme inhibitors; decrease metabolic clearance of warfarin and increase anticoagulant effect.
4. **Warfarin × tetracyclines:** Tetracyclines suppress the bacterial flora and decrease vitamin K production, hence potentiate warfarin effect.

5. **Warfarin × aspirin and other NSAIDs:** NSAIDs have an antiplatelet effect and also displace warfarin from the plasma protein binding site, thus potentiate warfarin effect.

Contraindications

The contraindications for warfarin are similar to heparin. In addition, warfarin is contraindicated in pregnancy.

Oral direct thrombin inhibitor: Dabigatran etexilate is a prodrug, which is converted to dabigatran. No laboratory monitoring is required during dabigatran therapy.

Therapeutic Uses of Anticoagulants

The main aim of anticoagulant therapy is to prevent formation of intravascular thrombus or further extension of the already formed clot. They do not dissolve the clot or thrombus once it is formed. Treatment is initiated with an LMWH or UFH and continued for at least 4–5 days. An oral anticoagulant, warfarin, is usually started simultaneously as it has a delayed onset of action.

1. **Deep vein thrombosis and pulmonary embolism:** Venous thrombi are mainly formed of fibrin network with a long tail that can easily detach and result in embolization of pulmonary arteries. Anticoagulants are used for the treatment and prevention of thromboembolism in high-risk cases, e.g. prolonged hospitalization, prolonged immobilization, major surgery, major trauma, etc. Anticoagulants are used along with low-dose aspirin to prevent thromboembolism in patients undergoing haemodialysis and those with prosthetic heart valves.
2. **Myocardial infarction:** Anticoagulants (heparin, LMWH or fondaparinux) are used in patients with a high risk of embolism as they prevent the extension of the thrombus. Anticoagulants help to prevent recurrent attacks of myocardial infarction and stroke, especially when given in combination with low dose of aspirin. Heparin is used during coronary angioplasty.
3. **Other uses:** Unstable angina, atrial fibrillation and disseminated intravascular coagulation.

■ Fibrinolytics (Thrombolytics)

Fibrinolytics promote the conversion of plasminogen to plasmin. Plasmin degrades fibrin into fibrin degradation products and thus rapidly dissolves the blood clot (Fig. 9.3). Streptokinase, urokinase, alteplase, reteplase and tenecteplase are plasminogen activators (Table 9.2).

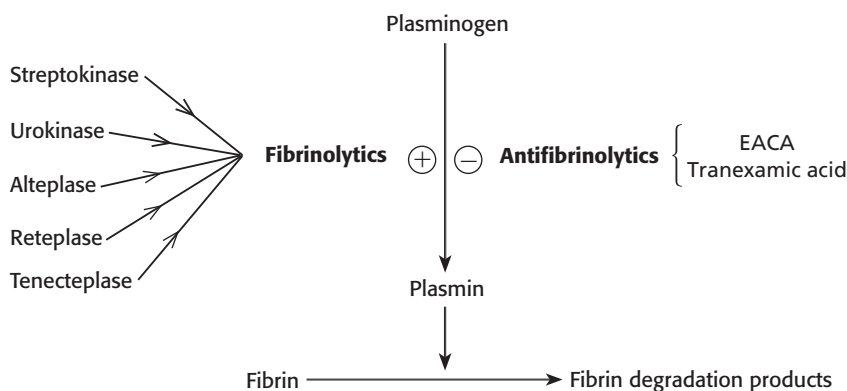

Fig. 9.3 The activation of plasminogen and drugs that affect it. EACA, epsilon amino-caproic acid.

Table 9.2 Pharmacological Properties of Fibrinolytics

Streptokinase	Urokinase	Alteplase (t-PA)
1. It is a protein derived from β -haemolytic streptococci	It is an enzyme isolated from human foetal kidney cell culture	It is derived from recombinant DNA technology
2. Streptokinase binds with circulating plasminogen to form a complex that activates plasminogen to plasmin	It directly activates plasminogen to plasmin	It selectively activates plasminogen that is bound to fibrin and avoids the activation of circulating plasminogen
3. Streptokinase is: <ul style="list-style-type: none"> • Antigenic • Pyrogenic • Destroyed by circulating antistreptococcal antibodies 	Urokinase is: <ul style="list-style-type: none"> • Nonantigenic • Not destroyed by antibodies 	Alteplase is: <ul style="list-style-type: none"> • Nonantigenic • Nonpyrogenic • Not destroyed by antibodies • Rapid acting • More potent • More effective • More expensive
4. Administered by i.v. infusion	Administered initially as i.v. bolus, followed by i.v. infusion	Administered initially as i.v. bolus, followed by i.v. infusion
5. Adverse effects: Bleeding, hypotension, allergic reactions like fever, chills, skin rashes and rarely anaphylactoid reaction	Bleeding can occur; but hypotension and allergic reactions are rare	Lower risk of bleeding and allergic reactions

Retepase and tenecteplase are obtained from DNA recombinant technology. They have longer plasma half-lives than alteplase.

Uses of fibrinolytics

1. **Acute MI:** The main aim of fibrinolytic therapy is to restore coronary artery patency. These drugs dissolve the clot by promoting the conversion of plasminogen to plasmin. Thrombolytic therapy is more effective if they are administered within 6–12 h of onset of symptoms.
2. **Deep vein thrombosis:** Thrombolytic therapy helps to prevent pulmonary embolism.
3. **Pulmonary embolism:** Fibrinolytics are used to lyse the clot.

Contraindications

These include recent trauma, recent surgery, recent abortion, recent stroke, severe hypertension, severe diabetes, severe liver damage, peptic ulcer and bleeding disorders.

■ Antifibrinolytics

Antifibrinolytics block the conversion of plasminogen to plasmin and thus inhibit fibrinolytic activity (Fig. 9.3).

Epsilon amino-caproic acid (EACA)

It is administered orally or intravenously. It is used mainly to control bleeding due to overdose of fibrinolytics after tooth extraction and surgery in haemophiliacs. It can also be used in haematuria and bleeding following obstetric complications. It rarely causes myopathy and muscle necrosis.

Tranexamic acid

It is available for oral, i.v. and topical administration. It is more potent than EACA. It is used to control bleeding due to excessive fibrinolytic activity and following tooth extraction, tonsillectomy, prostatectomy, etc. In dentistry, tranexamic acid soaked gauze or mouthwash can be used to reduce bleeding postoperatively in haemophiliacs and in patients on anticoagulant therapy. Its main side effects are nausea, vomiting, diarrhoea, headache, etc.

ANTIPLATELET DRUGS

Drugs that inhibit platelet aggregation are called antiplatelet drugs (Fig. 9.4).

Classification

1. **Thromboxane (TXA₂) synthesis inhibitor:** Low-dose aspirin.
2. **Phosphodiesterase inhibitor:** Dipyridamole.
3. **Thienopyridine derivatives:** Ticlopidine and clopidogrel.
4. **Glycoprotein (GP)-II_b/III_a-receptor antagonists:** Abciximab, eptifibatid and tirofiban.

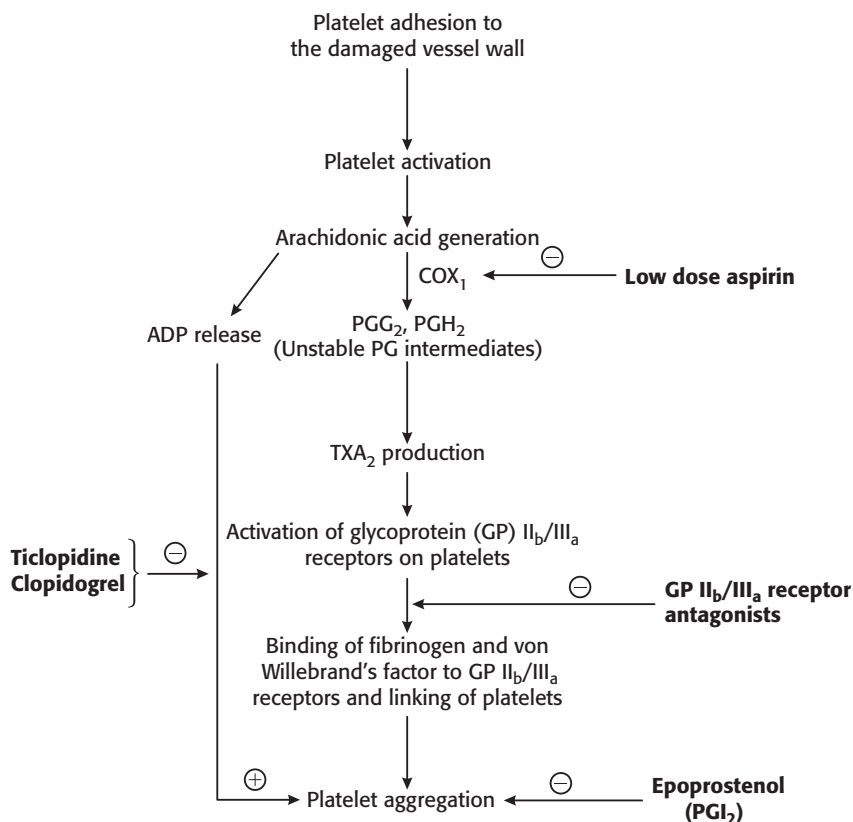

Fig. 9.4 Events of platelet aggregation with the site of action of antiplatelet drugs.

Aspirin (TXA₂ synthesis inhibitor)

Low-dose aspirin (50–325 mg) irreversibly acetylates platelet COX-I and reduces the production of TXA₂; thus the antiplatelet effect lasts for the life-time of the platelets, i.e. 7–10 days. In higher doses, aspirin inhibits both TXA₂ and PGI₂; hence efficacy is reduced. Common adverse effects are gastric irritation and bleeding (see p. 206, 207).

Dipyridamole (phosphodiesterase inhibitor)

It is a vasodilator. It inhibits phosphodiesterase and increases the concentration of cyclic adenosine monophosphate (cAMP) levels, which inhibits platelet aggregation. It is occasionally used in combination with warfarin during postoperative period in patients with prosthetic heart valves.

Ticlopidine and clopidogrel (thienopyridine derivatives)

They are prodrugs and structurally related. They inhibit adenosine diphosphate (ADP)-mediated platelet aggregation. Ticlopidine is well absorbed after oral administration and is converted to an active metabolite in liver. It has a long duration of antiplatelet effect. Side effects are nausea, vomiting, diarrhoea, leucopaenia, agranulocytosis, thrombocytopenia and GI bleeding. Clopidogrel is a congener of ticlopidine. It is also given orally. They produce synergistic effect when combined with aspirin or GP-II_b/III_a antagonists. Clopidogrel produces fewer side effects than ticlopidine; and it rarely produces neutropaenia and thrombocytopenia.

Abciximab, eptifibatid and tirofiban (GP II_b/III_a receptor antagonists)

They block GP II_b/III_a receptors for fibrinogen and von Willebrand's factor on platelet surface, thus inhibiting the final step in the process of platelet aggregation. These drugs are administered parenterally. The main side effect of these drugs is bleeding.

Uses

1. *Acute MI*: Low-dose aspirin is most commonly used in high-risk individuals to reduce the incidence of MI and in post-MI patients to prevent recurrent attacks.
2. They can also be used in unstable angina, transient ischaemic attacks, in patients with prosthetic heart valves, etc.

Key Points for Dentists

- Low molecular-weight heparins are safer than unfractionated heparin.
- Patient on anticoagulants should be instructed to report signs of bleeding.
- NSAIDs should be avoided in patients on anticoagulants and antiplatelet agents. Paracetamol and selective COX-2 inhibitors are safer as they have no antiplatelet action.
- Avoid intramuscular injections in patients on anticoagulants.
- Oral anticoagulants are contraindicated in pregnancy.
- INR and aPTT should be monitored in patients on warfarin and heparin, respectively, before a dental procedure.

HAEMATINICS

Haematinics such as iron, vitamin B₁₂, folic acid, etc. are required for the formation of blood and are used in the treatment of anaemia. In anaemia, there is decreased oxygen-carrying capacity of blood due to a reduction in blood haemoglobin level and number of circulating RBCs.

Causes of anaemia

1. **Decreased formation of RBCs:** Deficiency of essential nutrients—iron, vitamin B₁₂, folic acid, etc.
2. **Increased destruction of RBCs:** Haemolytic anaemias, sickle-cell anaemia.
3. **Depression of bone marrow:** Cytotoxic drugs, radiation, toxins.
4. **Excessive blood loss:** Due to hookworm infestation, bleeding from gastrointestinal tract (GIT) and other sites.

Iron

Iron is an essential element of the body. The important sources of iron are liver, fish, dry fruits, jaggery, spinach, banana, meat, etc.

Pharmacokinetics

Iron is an essential component of haemoglobin, myoglobin and a number of enzymes necessary for oxygen transfer (respiratory enzymes, cytochrome, etc.). Dietary iron exists in ferric form, which is reduced to ferrous iron with the help of acid in the stomach (Fig. 9.5). Absorption of most of the iron takes place in the duodenum and upper jejunum. Ferrous iron is oxidized in mucosal cells to ferric iron, and this combines with apoferritin to form ferritin.

The ferrous iron in plasma is oxidized again to ferric iron. This ferric iron gets incorporated into transferrin (transport protein). This is taken up by various tissues like reticulocytes in the bone marrow (Hb synthesis), reticuloendothelial cells in liver, spleen, etc. and stored. Small amount of iron is excreted

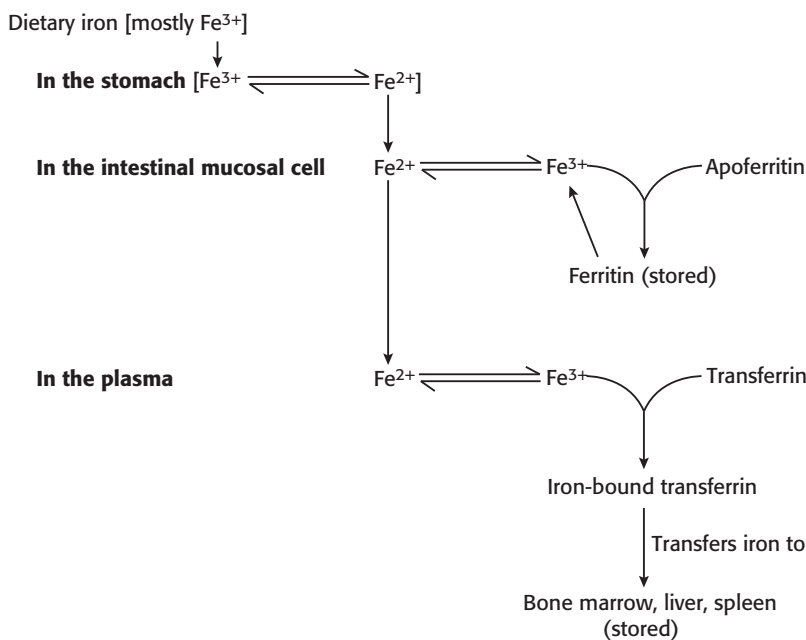

Fig. 9.5 Schematic representation of iron absorption and storage.

from the body mainly by shedding of gastrointestinal mucosal cells, desquamated skin; very little is lost in the bile, sweat and least in urine.

Factors affecting iron absorption

Iron absorption is facilitated by acidic pH of the stomach, ascorbic acid, cysteine, etc., which reduces the ferric iron to ferrous form. Iron-deficiency states also increase the absorption of iron. Iron absorption is inhibited by excess of phosphates, oxalates, phytates, etc. Milk, antacids and tetracyclines reduce iron absorption by forming insoluble complexes.

Preparations of iron

Oral preparations: Oral iron is preferred for the treatment of iron-deficiency anaemia. Various preparations are:

1. *Ferrous sulphate* contains 20% (hydrated salt) and 32% (dried salt) elemental iron. It is the oldest and cheapest iron preparation.
2. *Ferrous gluconate* contains 12% elemental iron.
3. *Ferrous fumarate* contains 33% elemental iron.

Other oral preparations are ferrous succinate, iron choline citrate, ferric ammonium citrate, etc.

Adverse effects of oral iron are nausea, vomiting, epigastric discomfort, dyspepsia, metallic taste, constipation or diarrhoea, and staining of teeth (mainly with liquid preparation).

Parenteral preparations

1. *Iron sorbitol citric acid complex (Jectofer)*: It is given intramuscularly, but never intravenously.
2. *Iron dextran complex (Imferon)*: It can be administered intravenously or intramuscularly. To prevent staining of the skin, intramuscular injection of iron preparations into the buttock is made using Z-track technique.
3. *Ferric carboxymaltose and ferrous sucrose* are administered intravenously. The risk of hypersensitivity reaction is much less with these preparations.

Indications for parenteral iron therapy

1. Intolerance to oral iron.
2. Severe malabsorption.
3. Non-compliance to oral iron.
4. Severe anaemia in the late stages of pregnancy.
5. Along with erythropoietin in patients with renal disease.

The total dose of parenteral iron is calculated by using the formula:

Iron requirement (mg) = $4.4 \times \text{body weight (kg)} \times \text{Hb deficit (g/dL)}$

(Normal Hb in men = 14–16 g%; women = 12–14 g%)

Adverse effects

The injections are painful, may cause abscess and discolouration of the skin at the site of injection. The systemic side effects are headache, pyrexia, nausea, vomiting, arthralgia, lymphadenopathy, urticaria and anaphylactic reaction (Test dose of iron preparation should be administered before giving full dose of parenteral iron).

Therapeutic uses of iron

1. **To treat iron-deficiency anaemia (microcytic hypochromic anaemia)**
 - a. During pregnancy.
 - b. Due to blood loss.
 - c. Due to nutritional iron deficiency.
 - d. Due to poor absorption of iron from the gut.

Most of the patients can be treated with oral iron. For treatment of iron-deficiency anaemia, 200 mg of elemental iron is required per day. Ferrous sulphate is the most commonly used preparation—200 mg of ferrous sulphate (60 mg elemental iron) is given thrice daily after food. Therapy should be continued till the Hb level returns to normal (4–8 weeks); and later, iron should be continued for at least 3–6 months to replenish iron stores. The expected rise in Hb concentration after iron therapy is 0.7–1 g/100 mL/week.

2. **Prophylaxis:** Prophylactic iron therapy is usually indicated during pregnancy and infancy. Iron is required prophylactically to meet the increased demand by the growing foetus and uterus and to combat loss during labour. For prophylaxis, 100 mg of elemental iron is administered daily, starting from the second trimester. Folic acid 0.5 mg/day is given from the first trimester to prevent neural tube defects.

Acute Iron Poisoning

It is seen frequently in young children. The manifestations are nausea, vomiting, epigastric pain, bloody diarrhoea, dehydration, cyanosis, drowsiness, hyperventilation, metabolic acidosis, convulsions, coma and death.

Treatment

- a. General measures.
- b. Specific therapy.

General measures

- *Supportive measures:* Airway, Breathing, Circulation, Fluid and Electrolyte and acid–base balance should be maintained.
- Whole bowel irrigation to remove unabsorbed iron pills from the GIT.
- Intravenous **Diazepam** to control convulsions.

Specific therapy

Desferrioxamine, a potent iron chelating agent, is administered by i.v. infusion or intramuscularly depending on the severity of poisoning. It binds with iron in the blood and facilitates its excretion.

Maturation Factors

Maturation factors are vitamin B₁₂ and folic acid. Both vitamin B₁₂ and folate are essential for DNA synthesis. The deficiency of one or both results in defective DNA synthesis and megaloblastic anaemia.

Vitamin B₁₂

Vitamin B₁₂ is a cobalt-containing compound, which is synthesized by the colonic bacteria and is present in food of animal origin, such as meat, liver, egg, fish, etc. Vitamin B₁₂ is essential for normal haemopoiesis and for the maintenance of normal myelin.

Metabolic functions

Vitamin B₁₂ acts as a coenzyme in certain metabolic pathways. It is necessary for the conversion of homocysteine to methionine and methylmalonyl CoA to succinyl CoA.

Pharmacokinetics (Fig. 9.6)

The ingested vitamin B₁₂ complexes with intrinsic factor (IF) in the stomach, which is secreted by gastric parietal cells. The vitamin B₁₂–IF complex reaches terminal ileum, where it binds to specific receptors,

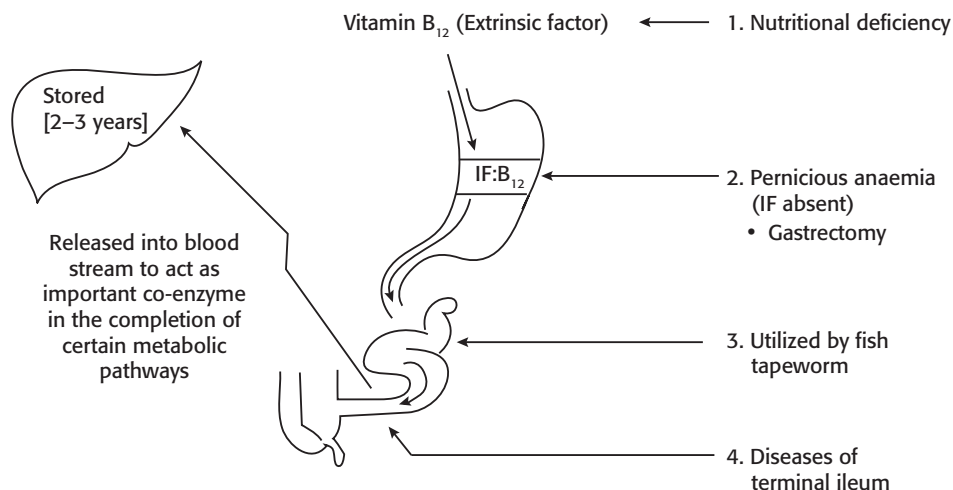

Fig. 9.6 Vitamin B₁₂ absorption and causes of deficiency.

and vitamin B₁₂ gets absorbed into blood. In blood, vitamin B₁₂ is bound to transcobalamin-II and is transported to various cells of the body. Excess vitamin B₁₂ is transported to liver for storage. Vitamin B₁₂ is excreted in bile and undergoes enterohepatic cycling.

Preparations

Cyanocobalamin (i.m. or s.c.), hydroxocobalamin (i.m.) and methylcobalamin (oral).

Vitamin B₁₂ is available for oral and parenteral administration (never administered intravenously because of risk of anaphylaxis). The choice of route depends on the cause of deficiency.

Uses

Pernicious anaemia: It is due to autoimmune destruction of the gastric parietal cells that synthesize intrinsic factor (IF). In pernicious anaemia, oral vitamin B₁₂ is not absorbed because of the deficiency of IF. Vitamin B₁₂ is injected intramuscularly—treatment is for lifetime. Administration of folic acid alone in vitamin B₁₂ deficiency may correct the megaloblastic anaemia but will aggravate or precipitate neurological abnormalities. This is due to the diversion of small quantities of vitamin B₁₂ present in the body to haemopoiesis.

Oral methylcobalamin has been used in the treatment of *trigeminal neuralgia, multiple sclerosis and other neuropathies*.

Folic Acid

Folic acid is a combination of glutamic acid, *para*-aminobenzoic acid and pteridine nucleus. It is abundantly found in fresh green leafy vegetables, liver, yeast, kidney, fruits, etc. Much of it is destroyed by cooking. Minimum daily requirement of an adult is 50–100 mcg. The requirement of folic acid increases during pregnancy and lactation, i.e. 500–800 mcg/day.

Pharmacokinetics

Most of the dietary folic acid is found as polyglutamates, but these are not absorbed unless they are cleaved to monoglutamate by the action of intestinal enzyme folate conjugase. It is readily absorbed in the proximal part of the jejunum. In the mucosa of the jejunum, it is reduced to tetrahydrofolate,

which then gets methylated. In blood, it is transported to various tissues as methyl tetrahydrofolate (MTHF). Constant supply of MTHF is maintained by food intake and enterohepatic cycling. Folate is stored mainly in liver. The stores are exhausted in about 3–4 months; hence manifestations of folate deficiency appear in about 3–4 months.

Folic acid itself is inactive. Its active form tetrahydrofolate is essential for the biosynthesis of amino acids, purines, pyrimidines, choline, DNA and therefore in cell division.

Causes of folate deficiency

1. Dietary deficiency: most common.
2. Decreased absorption (malabsorption, tropical sprue).
3. Diminished storage (hepatic disease, vitamin C deficiency).
4. Decreased utilization (phenytoin, phenobarbitone).
5. Increased demand (pregnancy, lactation, haemolytic anaemias).
6. Drug induced (antifolates: methotrexate, trimethoprim, pyrimethamine).

Manifestations of folate deficiency

1. Megaloblastic anaemia—microscopically, the blood picture is similar in both folate and vitamin B₁₂ deficiency.
2. Glossitis, diarrhoea, general weakness and weight loss.

Preparations

Folic acid is available for oral (tablet and liquid) and parenteral administration (combination with other vitamins or iron).

Uses

1. *Megaloblastic anaemia due to:*

- a. Nutritional folate deficiency.
- b. Increased demand (pregnancy, lactation).
- c. Pernicious anaemia—along with vitamin B₁₂.

Folic acid is given orally in a dose of 1–5 mg daily and continued for about 3–4 months. Administration of folic acid alone in vitamin B₁₂ deficiency may correct the megaloblastic anaemia but will aggravate or precipitate neurological abnormalities. This is due to the diversion of small quantities of vitamin B₁₂ present in the body to haemopoiesis.

2. **Prophylactic therapy:** During pregnancy, routine prophylactic folic acid 0.5 mg/day is given from the first trimester to prevent neural tube defects.
3. **Methotrexate toxicity:** Folinic acid, active form of folic acid, is used to antagonize methotrexate toxicity (see p. 363).

Adverse effects

Oral folic acid is safe, but injections may rarely cause hypersensitivity reactions.

Key Points for Dentists

- Oral iron preparations should be kept away from children.
- Patient should be told to drink water after taking oral iron, especially liquid preparations.
- Intramuscular injections of iron preparations are administered by 'Z-track' technique.
- Folic acid is started early in pregnancy to prevent neural tube defects.
- Folic acid should never be used alone in vitamin B₁₂ deficiency, as it can aggravate/precipitate neurological abnormalities.
- Vitamin B₁₂ should not be given intravenously because of the risk of anaphylaxis.

This page intentionally left blank

INTRODUCTION

Hormone is a substance produced by specialized cells in specific glands and transported to a distance where it acts on target tissues.

Types of hormones

1. **Peptides:** Hypothalamic regulatory hormones, pituitary hormones, insulin, glucagon, parathyroid hormones.
2. **Steroids:** Adrenocortical hormones, sex steroids.
3. **Catecholamines:** Adrenaline, noradrenaline.
4. **Others:** Thyroxine (T_4), triiodothyronine (T_3).

Site and mode of action of hormones

Hormones act on their specific receptors situated:

1. On the cell membrane:

- a. Some hormones bind with the cell membrane receptors and increase cAMP concentration, e.g. catecholamines, most of the peptide hormones.

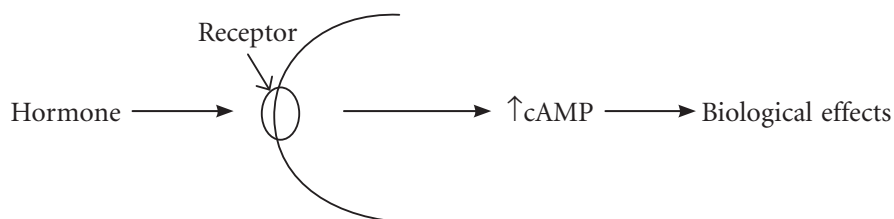

- b. Some hormones cause inhibition of cAMP production by binding to cell membrane receptors, e.g. somatostatin.

2. In the cytoplasm:

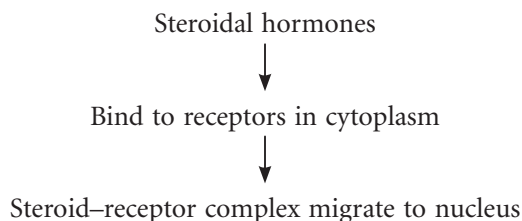

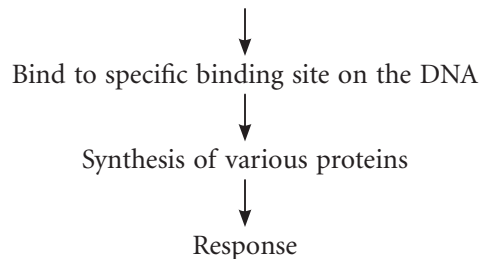

3. *In the nucleus:*

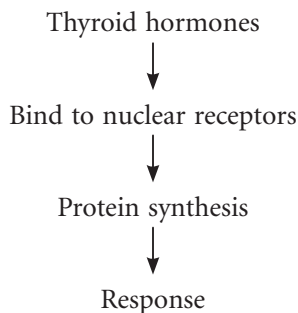

HYPOTHALAMIC AND PITUITARY HORMONES

Hypothalamic Regulatory Hormones

Hypothalamus produces releasing and inhibitory hormones that control pituitary secretion (Fig. 10.1). *Hypothalamus* controls the secretion of anterior pituitary through portal circulation that carries the releasing and inhibitory hormones.

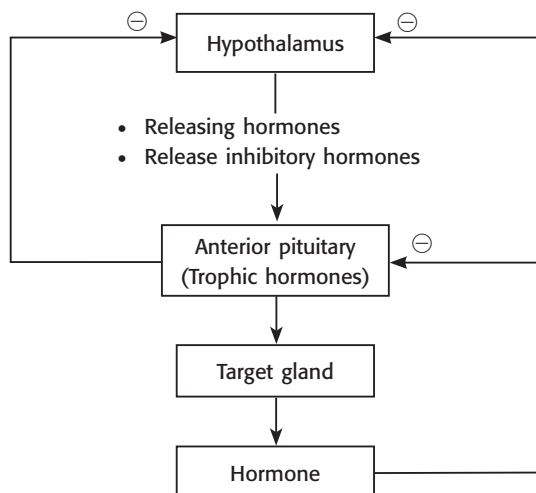

Fig. 10.1 Regulation of anterior pituitary hormone synthesis and release; \ominus = Inhibition.

Anterior Pituitary Hormones

1. Growth hormone (GH).
2. Prolactin (PRL).
3. Gonadotropins (FSH and LH).
4. Adrenocorticotrophic hormone (ACTH).
5. Thyrotropin- or thyroid-stimulating hormone (TSH).
6. Melanocyte-stimulating hormone (MSH).

THYROID HORMONES AND ANTITHYROID DRUGS

The hormones secreted by the thyroid gland are thyroxine (T_4), triiodothyronine (T_3) and calcitonin. The thyroid follicular cells have specialized mechanism for the synthesis of thyroid hormones. This is regulated by TSH secreted by anterior pituitary, which, in turn, is inhibited by the free thyroid hormone levels (Fig. 10.2). The 'C' cells of thyroid secrete calcitonin, which is a functionally distinct hormone regulating calcium metabolism.

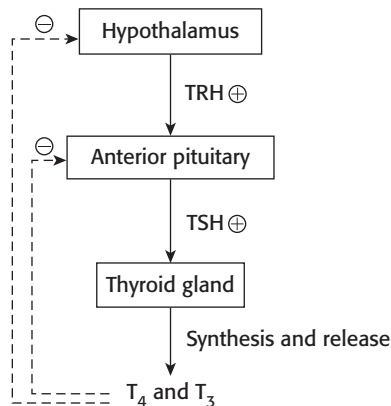

Fig. 10.2 Control of thyroid hormone synthesis and release. TRH, thyrotropin-releasing hormone; TSH, thyroid stimulating hormone; ⊕, stimulation; ⊖, inhibition.

Deficiency of thyroid hormones in children results in cretinism characterized by mental retardation and other features of hypothyroidism (Table 10.1); in adults, it results in myxedema. Hypersecretion of these hormones also has effects on various organ systems resulting in 'thyrotoxicosis'.

Drugs used for treating hyperthyroidism are called antithyroid drugs. These drugs play an important role in the management of hyperthyroidism caused by both benign and malignant conditions of thyroid gland.

Thyroid Hormones

Synthesis of thyroid hormones

1. **Iodide trapping:** Active transport of iodide ions (I^-) into follicular cells of thyroid gland is known as iodide trapping and takes place by a basement membrane protein called the sodium/iodide symporter. This process can be inhibited by thiocyanates and perchlorates, which compete with iodide.

Table 10.1 Features of Hyperthyroidism and Hypothyroidism

System	Hyperthyroidism (Thyrotoxicosis)	Hypothyroidism (Myxedema)
1. Metabolic	Increased basal metabolic rate (BMR)	Decreased BMR
• Lipid	Decreased cholesterol and triglycerides	Hypercholesterolaemia and hypertriglyceridaemia
• Carbohydrate	Increased glycogenolysis and gluconeogenesis → hyperglycaemia	Hypoglycaemia in severe myxedema (decreased insulin degradation)
• Protein	Negative nitrogen balance and wasting	Positive nitrogen balance and weight gain due to accumulation of mucoproteins
2. Cardiovascular	Increased heart rate, stroke volume, cardiac output with decreased peripheral vascular resistance, high-output cardiac failure, arrhythmias, angina	Decreased heart rate, stroke volume, cardiac output, low-output cardiac failure, pericardial effusion
3. CNS	Nervousness, anxiety	Lethargy and mental retardation in cretinism
4. Musculoskeletal system	Weakness, muscle fatigue, increased deep tendon reflexes, hypercalcaemia, osteoporosis	Stiffness and muscle fatigue
5. Gastrointestinal	Increased appetite, diarrhoea	Decreased appetite, constipation, ascites
6. Haematopoietic	Anaemia due to increased RBC turnover, usually normochromic	Anaemia due to decreased RBC production—may be normochromic, hyperchromic or hypochromic
7. Reproductive	Menstrual irregularities, decreased fertility	Menorrhagia, infertility, decreased libido, impotence, oligospermia
8. Eyes and face	Lid retraction, periorbital oedema, exophthalmos	Puffy face, large tongue
9. Skin and appendages	Warm moist skin; heat intolerance; fine, thin hair	Pale, dry skin, intolerance to cold, brittle hair and nail

2. **Oxidation and iodination:** The iodide ion is oxidized to iodine by peroxidase enzyme. Iodine combines with tyrosine residues of thyroglobulin molecule and forms monoiodotyrosine (MIT) and diiodotyrosine (DIT). The peroxidase enzyme is transiently blocked by high levels of iodide in the follicular cells and persistently blocked by thiourea group of antithyroid drugs.

3. **Coupling:** This is the final step in the synthesis of thyroid hormones. Two molecules of DIT couple to form thyroxine (T_4), and one molecule of MIT with one molecule of DIT forms triiodothyronine (T_3).

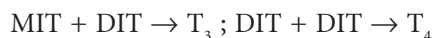

4. **Hormone release:** Release of thyroid hormones takes place under the control of TSH. The process involves endocytosis and proteolysis of iodinated thyroglobulin and results in release of T_4 , T_3 , MIT and DIT. The process of proteolysis is also inhibited by high levels of intrafollicular iodide.

5. **Peripheral conversion of T_4 to T_3 :** Most of the hormone released from thyroid is T_4 , which is much less potent in comparison to T_3 . Conversion of T_4 to T_3 in periphery is inhibited by propylthiouracil, iopanoic acid, propranolol and glucocorticoids.

Differences between T₃ and T₄

T ₃ (Triiodothyronine)	T ₄ (Thyroxine)
Formed by DIT + MIT = T ₃	Formed by DIT + DIT = T ₄
Relatively rapid onset of action	Slower onset of action
Short duration of action (half-life 1 day)	Long duration of action (half-life 7 days)
More potent than T ₄	Less potent
Used to treat myxedema coma	Myxedema coma and regular treatment of myxedema

Mechanism of action

Mechanism of action of thyroid hormones is similar to that of steroid hormones. Thyroxine needs to be converted into T₃ inside the cell for binding to the nuclear receptor.

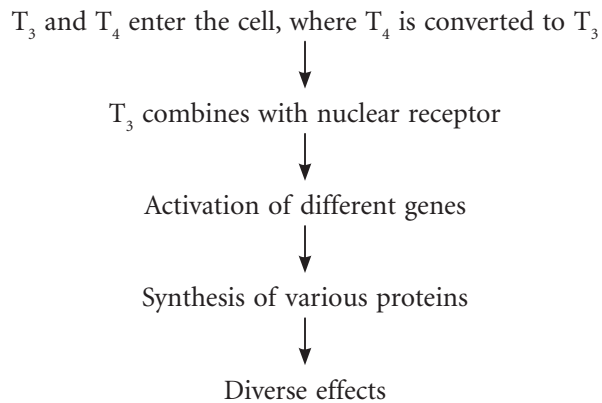

Preparations

1. Levothyroxine sodium (T₄): Tablets and parenteral preparation (i.v.).
2. Liothyronine (T₃, triiodothyronine): Oral tablets, parenteral preparation (not commonly available).

Therapeutic uses: Replacement therapy in hypothyroid states

1. **Cretinism and myxedema:** For cretinism, treatment should be started as early as possible after birth. In young adults, full replacement doses of levothyroxine sodium can be administered (50–100 mcg daily as a single dose orally in the morning on an empty stomach).
2. **Myxedema coma:** This is a medical emergency and usually common in longstanding untreated myxedema cases. It is treated with levothyroxine, intravenously (i.v.) if available, otherwise via nasogastric tube.

■ Antithyroid Drugs (Fig. 10.3)

These drugs reduce the level of thyroid hormones by reducing thyroid hormone synthesis or release or both. They are used in the treatment of hyperthyroid conditions.

Classification

1. Thyroid hormone **synthesis inhibitors** (thioamides or thiourea derivatives): Propylthiouracil, methimazole, carbimazole.
2. Hormone-**release inhibitors**: Iodine, iodides of Na⁺ and K⁺, organic iodide.

3. Thyroid **tissue-destroying** agent: Radioactive iodine (^{131}I).
4. **Others**: Propranolol, diltiazem, dexamethasone.

Thioamides

Propylthiouracil, methimazole and carbimazole are thioamides used to treat hyperthyroidism. Their mechanism of action is depicted in Figure 10.3.

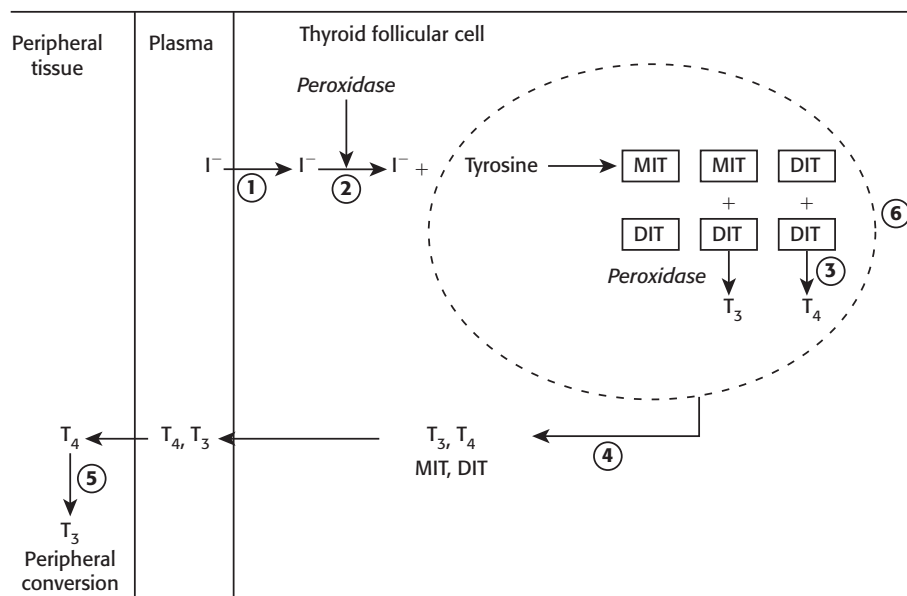

Fig. 10.3 Synthesis, storage and secretion of thyroid hormones and drugs affecting them. *Site 1:* Thiocyanates, perchlorates, excess iodides. *Sites 2 and 3:* Iodides, thioamides. *Site 4:* Iodides. *Site 5:* Propylthiouracil, propranolol, iopanoic acid, ipodate, glucocorticoids. *Site 6:* Radioactive iodine (destruction of thyroid tissue).

Mechanism of action of thioamides (Fig. 10.3)

1. They inhibit thyroid peroxidase enzyme, which converts iodide to iodine.
2. They inhibit iodination of tyrosine residues in thyroglobulin.
3. They inhibit coupling of iodotyrosines (MIT and DIT).

Propylthiouracil also inhibits the peripheral deiodination of T_4 to T_3 .

Pharmacokinetics

Thioamides are well absorbed orally. Propylthiouracil is most rapidly absorbed. Carbimazole is converted to methimazole after absorption. They are widely distributed but get accumulated in thyroid gland. Propylthiouracil has a short half-life and needs to be given every 6–8 h. They cross the placental barrier and can cause foetal hypothyroidism. They are excreted in urine.

Adverse effects

Skin rashes are most common. The other side effects are joint pain, fever, hepatitis, nephritis, etc. A dangerous but rare adverse effect is agranulocytosis, which usually occurs during first few weeks or months of therapy; but it may occur later also. This may develop rapidly, so regular blood counts may

not be helpful. The drugs should be stopped at the first sign of agranulocytosis, i.e. sore throat and/or fever.

Uses

1. For long-term treatment of thyrotoxicosis where surgery is not indicated or not feasible and radioactive iodine is contraindicated.
2. Along with radioactive iodine to hasten recovery in thyrotoxicosis.
3. For treatment of thyrotoxic crisis along with iodide and propranolol.

◆ Iodine and Iodides

Iodides are the oldest agents used to treat hyperthyroidism. They can inhibit all steps in the synthesis of thyroid hormones, but the major effect is inhibition of release of thyroid hormones.

Preparations and uses of iodine and iodides

1. **Lugol's iodine** (5% iodine in 10% solution of KI): It is used orally preoperatively before thyroidectomy and in thyroid storm. It renders the gland firm, less vascular and decrease its size, which makes surgery convenient with less bleeding and complications.
2. **As an expectorant**: Potassium iodide (KI) acts as a mucolytic agent that enhances expectoration.
3. **As an antiseptic**: Tincture of iodine (iodine in alcohol).
4. **Prophylaxis of endemic goitre**: Iodized salt is used.

Adverse effects

Allergic reactions: Angioedema, laryngeal oedema, arthralgia, fever, eosinophilia, and lymphadenopathy may occur acutely (type-III hypersensitivity). Chronic overdose with iodide results in iodism. The symptoms are headache, sneezing and irritation of eyes with swelling of eyelids, and sometimes pulmonary oedema can occur. These resolve after few days of stopping iodine. Hypothyroidism may also occur; use of iodides during pregnancy may cause foetal goitre.

◆ Radioactive Iodine

Therapeutically used radioactive iodine is ^{131}I . Sodium iodide containing ^{123}I is used for diagnostic scan.

Radioactive iodine gets concentrated in the same way as stable iodine in thyroid, and emits γ -rays and β -particles. The β -particles cause destruction of the follicular cells leading to fibrosis and correction of hyperthyroid state.

Preparation

^{131}I is used orally as solution or capsule. The dose is expressed in microcurie.

Uses and contraindications

Radioactive iodine is used in hyperthyroidism due to adenoma or carcinoma when surgery is not feasible or contraindicated. It is contraindicated in pregnancy, children and nursing mother.

Advantages

1. Treatment is simple; does not require hospitalization—can be done in the outpatient department.
2. Not expensive.
3. No risk of surgery and scar.
4. Permanently cures hyperthyroidism.

Disadvantages

It is slow acting and causes local soreness in the neck. Incidence of hypothyroidism is high. It is not suitable for pregnant women, children and young patients.

β-Adrenoceptor Blockers (β-Blockers)

Although β-blockers are not strictly antithyroid drugs, they produce dramatic improvement in symptoms of thyrotoxicosis like tachycardia, palpitation and tremors. Propranolol also has an inhibitory effect on peripheral conversion of T_4 to T_3 .

Uses

1. To control symptoms of thyrotoxicosis initially till antithyroid drugs act.
2. In thyrotoxic crisis.
3. Preoperatively before thyroid surgery.

Thyrototoxic Crisis (Thyroid Storm)

This is due to very high levels of circulating thyroid hormone. Besides the usual features of hyperthyroidism, this is characterized by hyperpyrexia, cardiac arrhythmias, nausea, vomiting, diarrhoea and mental confusion. It is usually precipitated by infection, trauma, surgery, etc. This condition is treated with propylthiouracil, iodides, propranolol and hydrocortisone.

Key Points for Dentists

- Local anaesthetic with adrenaline should be avoided in patients with hyperthyroidism.
- Benzodiazepines and opioid analgesics should be used cautiously in patients with hypothyroidism as they may precipitate myxedema coma.

ANABOLIC STEROIDS

Anabolic steroids promote protein synthesis and increase muscle mass, resulting in weight gain. They are synthetic androgens with greater anabolic and lesser androgenic activity. Testosterone has potent anabolic effect, but it cannot be used because of its strong androgenic effect. The anabolic to androgenic ratio with testosterone is 1. Some of the commonly used anabolic steroids are Nandrolone (i.m.), Oxandrolone (oral), Stanozolol (oral), Ethylestrenol (oral) and Methandienone (oral, i.m.). [Mnemonic: **NOSE, M.**]

Uses

1. In chronic illness, to improve appetite and feeling of well-being.
2. During recovery from prolonged illness, surgery, burns, trauma or chronic debilitating diseases.
3. To counteract the catabolic effects of exogenously administered adrenal cortical hormones.
4. In postmenopausal and senile osteoporosis.

Anabolic steroids are often misused by athletes to increase muscle strength and athletic performance; hence they are included in the 'dope test'.

Adverse effects

1. In females, androgens cause virilization leading to hirsutism, menstrual irregularities, breast atrophy, acne and deepening of voice.
2. In children, impairment of growth due to premature closure of epiphyses.
3. Sodium and water retention leading to oedema.

Key Points for Dentists

→ Anabolic steroids enhance muscle strength and power; hence they are often misused by athletes. Their use by athletes is prohibited. They can be detected in the urine by antidoping investigations.

CORTICOSTEROIDS

Adrenal gland has cortex and medulla. Adrenal cortex secretes steroidal hormones; adrenal medulla secretes adrenaline and noradrenaline. Hormones of adrenal cortex are given in Table 10.2.

Adrenal cortical hormones are more important than medullary hormones. Among cortical hormones, mineralocorticoids are more essential than glucocorticoids.

Table 10.2 Anatomical and Functional Divisions of Adrenal Cortex

Layers of Adrenal Cortex	Zona Glomerulosa	Zona Fasciculata	Zona Reticularis
Hormones secreted	Mineralocorticoids: Aldosterone Desoxycorticosterone	Glucocorticoids: Hydrocortisone (cortisol)	Androgens
Main actions	Regulate water and electrolyte balance	Metabolic (carbohydrate, protein and fat), antiinflammatory, immunosuppressant and antiallergic actions	
Hypersecretion	Primary hyperaldosteronism (Conn's syndrome)	Cushing's syndrome	Adrenogenital syndrome (precocious puberty)
Deficiency of adrenal cortical hormones (chronic)	← Addison's disease →		

Synthesis and release of glucocorticoids is controlled by pituitary adrenocorticotropic hormone (ACTH), which in turn is stimulated by corticotrophin-releasing factor (CRF) produced by hypothalamus. Glucocorticoids have negative feedback control on ACTH and CRF secretion (Fig. 10.4).

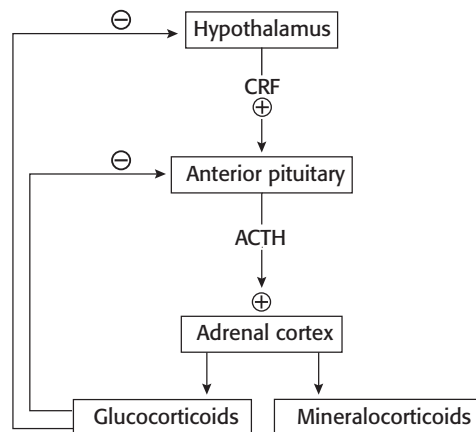

Fig. 10.4 Regulation of synthesis and secretion of corticosteroids. CRF, corticotropin-releasing factor; ACTH, adrenocorticotropic hormone; ⊕, stimulation, ⊖, inhibition.

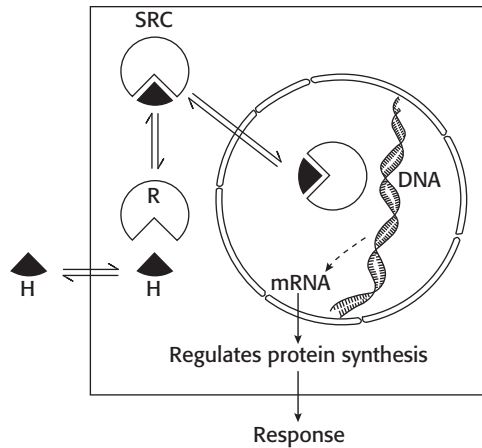

Fig. 10.5 Mechanism of action of steroid hormones. H, hormone; R, receptor; SRC, steroid–receptor complex.

Mineralocorticoid (e.g. aldosterone) release is controlled by the renin–angiotensin system. There is a diurnal variation in the rate of release of ACTH and cortisol (circadian rhythm). The plasma cortisol levels are highest in the early hours of morning and the lowest in the late evening. The long-term use of corticosteroids in large doses will decrease ACTH secretion and gradually cause adrenal cortical atrophy. Hence, sudden stoppage of corticosteroids after prolonged treatment is dangerous and can precipitate acute adrenal insufficiency.

Mechanism of action of steroid hormones

The mechanism of action of steroid hormones is depicted in Figure 10.5.

Steroid hormone enters the cells of target organ

Binds to specific receptors in the cytoplasm

Steroid–receptor complex becomes activated

Enters the nucleus

Binds to specific site on the DNA

Regulates protein synthesis

Response

Classification and important features of corticosteroids: See Table 10.3.

Table 10.3 Comparison of Corticosteroids Using Hydrocortisone as a Standard

Agent	Activity		Equivalent dose (mg) (Antiinflammatory)	Uses and route of administration
	Antiinflammatory	Salt retaining		
1. Glucocorticoids				
(a) Short acting (8–12 hours)				
(i) Hydrocortisone (cortisol)	1	1	20	It has a rapid onset but short duration of action. It is the drug of choice for replacement therapy in acute adrenal insufficiency. Other uses are status asthmaticus and anaphylactic shock (emergency uses) <i>Routes:</i> Oral, i.m., i.v., intra-articular and topical
(ii) Cortisone	0.8	0.8	25	It is cheap; prodrug, converted to hydrocortisone after metabolism in liver; rarely used at present
(b) Intermediate acting (12–36 hours)				
(i) Prednisolone	4	0.8	5	It is the most commonly used preparation for allergic, inflammatory, autoimmune disorders and in malignancies. It causes less HPA axis suppression if given once daily in the morning <i>Routes:</i> Oral, i.m., intra-articular and topical
(ii) Prednisone	4	0.8	5	It is a prodrug, gets converted to prednisolone in liver; less efficacious, hence rarely used
(iii) Methyl-prednisolone	5	0.5	4	It is used for its antiinflammatory and immunosuppressant effects; as high-dose pulse therapy in renal transplant, pemphigus vulgaris, etc. <i>Routes:</i> i.m., i.v., retention enema in ulcerative colitis
(iv) Triamcinolone*	5	0	4	More potent and relatively more toxic than prednisolone. It has no mineralocorticoid activity <i>Routes:</i> Oral, i.m., intra-articular and topical

(Contd...)

Table 10.3 Comparison of Corticosteroids Using Hydrocortisone as a Standard (Contd...)

Agent	Activity		Equivalent dose (mg) (Antiinflammatory)	Uses and route of administration
	Antiinflammatory	Salt retaining		
(c) Long acting (36–72 hours)				Long acting; have highly potent antiinflammatory and immunosuppressant effects. Have no mineralocorticoid activity
(i) Betamethasone*	30	0	0.75	They cause severe HPA axis suppression. Used in allergic and inflammatory conditions; cerebral oedema due to neoplasm, where water retention is undesirable and to promote lung maturation in fetus when premature delivery is anticipated <i>Routes:</i> Oral, i.v., i.m. and topical
(ii) Dexamethasone*	30	0	0.75	
Local acting glucocorticoids				They have local action
(i) Beclomethasone	+	–	–	It is used by inhalation in bronchial asthma, as nasal spray for allergic rhinitis; as ointment for skin and mucous membrane lesions. HPA-axis suppression is minimal
(ii) Budesonide	+	–	–	Same as beclomethasone, but is more potent than beclomethasone
(iii) Fluticasone	+	–	–	It is used by inhalation for asthma and chronic obstructive pulmonary disease (COPD); orally for inflammatory bowel disease; as ointment for skin and mucous membrane lesions
2. Mineralocorticoids				
(i) Desoxycorticosterone acetate (DOCA)	0	100	–	It has selective mineralocorticoid activity and is used in Addison's disease as replacement therapy
(ii) Fludrocortisone	10	125	2	Has potent mineralocorticoid activity. It is used with hydrocortisone for replacement therapy in Addison's disease
(iii) Aldosterone	0.3	3000	–	Not used

*'am' containing drugs have no mineralocorticoid activity. +, Activity present; –, Activity absent.

Pharmacological actions

Corticosteroid with predominant sodium and water retaining property, e.g. aldosterone and desoxycorticosterone, are mineralocorticoids. Corticosteroid with predominant liver glycogen deposition and gluconeogenic effects, e.g. hydrocortisone (cortisol) and cortisone, are glucocorticoids (Table 10.3). The two actions (mineralocorticoid and glucocorticoid) are not completely separated in naturally occurring steroids, whereas synthetic preparations are available with selective action.

Carbohydrate metabolism

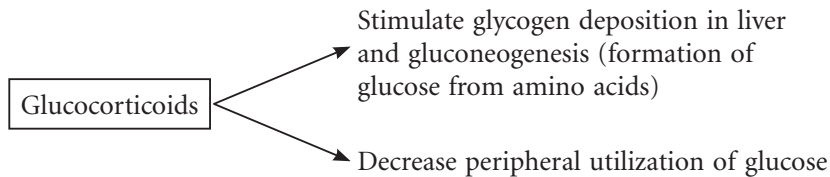

The net result is: (i) hyperglycaemia, (ii) decreased tissue sensitivity to insulin and (iii) diabetes may be precipitated or exacerbated. Therefore, glucocorticoids are (relatively) contraindicated in diabetics.

Lipid metabolism

Prolonged use of glucocorticoids causes redistribution of body fat that is deposited over the neck, face, shoulder, etc. resulting in 'moon face', 'buffalo hump' and 'fish mouth' with thin limbs.

Protein metabolism

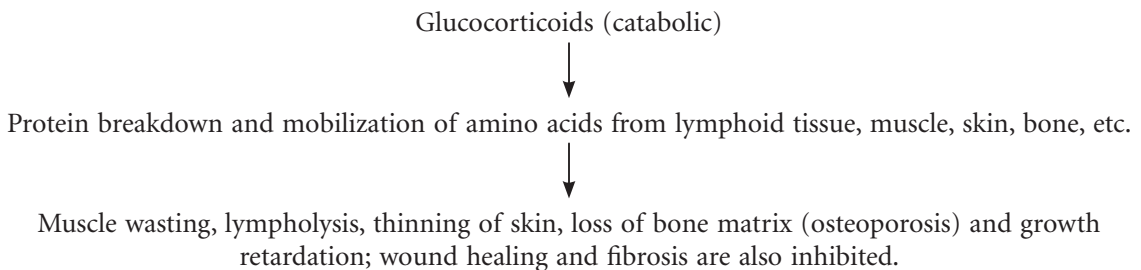

Electrolyte and water metabolism

Glucocorticoids have weak mineralocorticoid action, cause sodium and water retention and promote potassium excretion. Thus, prolonged use of these drugs may cause oedema and hypertension. The synthetic glucocorticoids (dexamethasone, betamethasone, and triamcinolone) have no sodium and water retaining property.

Calcium metabolism (anti-vitamin D action)

Prolonged use of these drugs may lead to osteoporosis and pathological fracture of vertebral bodies.

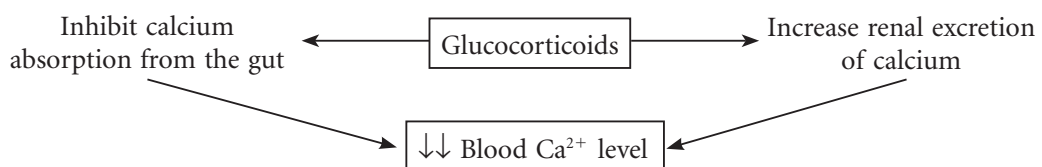

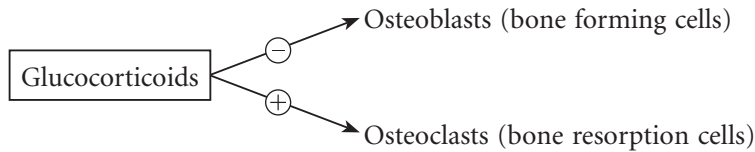
Bone**Cardiovascular system**

Glucocorticoids have sodium and water retaining property and have permissive effect on pressor action of adrenaline and angiotensin. On chronic administration, these drugs may cause hypertension and worsening of congestive cardiac failure (CCF).

Skeletal muscles

Corticosteroids are required for the normal function of skeletal muscles. Weakness occurs in both hypocorticism and hypercorticism.

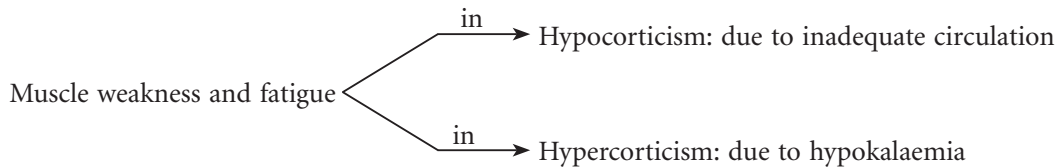

Prolonged use of glucocorticoids may cause muscle wasting and weakness (steroid myopathy).

Central nervous system

Corticosteroids have a number of indirect effects on the CNS through maintenance of (i) blood pressure, (ii) blood glucose concentration and (iii) electrolyte levels.

They also have direct effects on the CNS and influence mood and behaviour. Patients with Addison's disease show mental depression, irritability and even psychosis. On the other hand, glucocorticoid therapy can cause euphoria, insomnia, restlessness and psychosis.

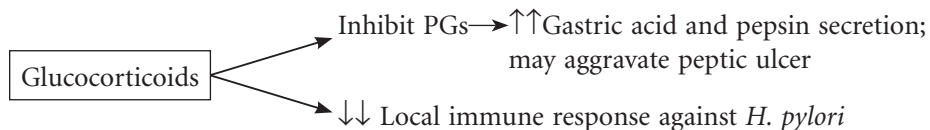
Gastrointestinal tract**Blood and lymphoid tissue**

Glucocorticoid therapy leads to a decrease in the number of circulating lymphocytes, eosinophils, basophils and monocytes. This is due to redistribution of cells. They have a marked lympholytic action; therefore they are used in lymphomas and leukaemias.

Antiinflammatory effect

They have powerful antiinflammatory and immunosuppressant effects. They prevent or suppress the clinical features of inflammation such as redness, heat, pain and swelling. At tissue level, they suppress the early phenomena (capillary permeability, oedema, cellular infiltration and phagocytosis) and late responses like capillary proliferation, collagen deposition, fibroblast activity and scar formation.

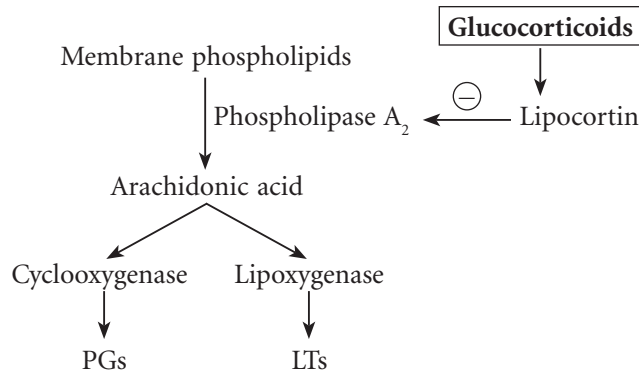

1. Glucocorticoids induce a protein called lipocortin, which inhibits phospholipase A₂, so prostaglandins (PGs), leukotrienes (LTs) and PAF are not formed.
2. Tumour necrosis factor-alpha (TNF- α) is inhibited by glucocorticoids, which is necessary for initiating inflammatory process.
3. Glucocorticoids stabilize the lysosomal membrane and prevent the release of inflammatory mediators.

Immunosuppressant effect

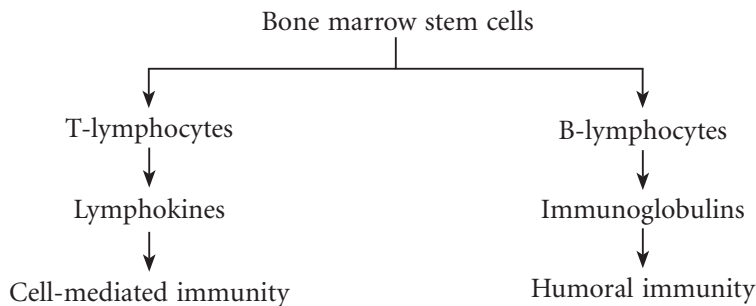

Glucocorticoids have immunosuppressant effect. They inhibit both B-cell and T-cell lymphocyte functions, and this results in impairment of humoral and cell-mediated immunity. Cell-mediated responses may be inhibited indirectly by inhibiting the production of cytokines, including TNF- α and interleukins. They also suppress all types of hypersensitivity or allergic reactions.

Adverse reactions

A single dose of glucocorticoids is practically harmless; rather they are life-saving drugs in conditions like anaphylactic shock, acute adrenal insufficiency, etc. The use of glucocorticoids in supraphysiological doses for more than 2–3 weeks causes a number of undesirable effects. Most of the adverse effects are extension of pharmacological actions.

1. **Metabolic effects:** Hyperglycaemia, precipitation of diabetes mellitus (DM) or aggravation of pre-existing diabetes.
2. **Cushing's habitus:** Abnormal fat distribution causes peculiar features with moon face, buffalo hump and thin limbs.

3. **Gastrointestinal tract:** Peptic ulceration sometimes with haemorrhage or perforation.
4. **Salt and water retention:** Mineralocorticoid effect may cause oedema, hypertension and even precipitation of CCF, particularly in patients with primary hyperaldosteronism. This can be minimized by using synthetic steroids like dexamethasone, betamethasone, etc.
5. **Muscle:** Steroid treatment can cause hypokalaemia leading to muscle weakness and fatigability. Long-term steroid therapy leads to steroid myopathy.
6. **Bone:** Osteoporosis with pathological fractures of vertebral bodies is common. Ischaemic necrosis of the femoral head can also occur.
7. **Growth retardation** in children is more common with dexamethasone and betamethasone.
8. **Eye:** Glaucoma and cataract may occur on prolonged therapy.
9. **Central nervous system:** Behavioural disturbances like nervousness, insomnia, mood changes can occur; psychosis may be precipitated.
10. **Long-term therapy** with steroids leads to immunosuppression, which makes the patient more vulnerable to various infections like fungal (candidiasis, cryptococcosis), viral (herpes, viral hepatitis), bacterial (reactivation of latent tuberculosis), etc. Inhalational steroids can cause local irritation and fungal infection of upper respiratory tract, which can be prevented by the use of spacer and by rinsing the mouth after inhalation.
11. **Hypothalamic–pituitary–adrenal (HPA) axis suppression:** The most dangerous side effect of long-term steroid therapy is HPA-axis suppression. Therefore, the important precautions to be taken during long-term steroid therapy to minimise HPA-axis suppression are:
 - a. Whenever possible, topical use of steroids is preferred.
 - b. Short- or intermediate-acting steroids (e.g. hydrocortisone, prednisolone) should be preferred.
 - c. Give steroids as a single morning dose at 8 a.m.; if the daily dose is high, two-third of the dose in the morning and one-third in the evening, which will mimic the endogenous hormone levels and minimize the chances of HPA axis suppression.
 - d. Try alternate-day steroid therapy in chronic conditions like bronchial asthma, nephrotic syndrome, systemic lupus erythematosus (SLE), etc.
 - e. Withdrawal of steroids after long-term (>2 weeks) treatment should be very slow to allow recovery of normal adrenocortical function. The doses of steroid should be tapered gradually.

Abrupt stoppage of glucocorticoid therapy following prolonged use leads to:

- flaring up of the underlying disease being treated.
- withdrawal symptoms like fever, myalgia, arthralgia, malaise, etc.
- acute adrenal insufficiency on exposure to stress, which manifests as anorexia, nausea, vomiting, abdominal pain, hypotension, dehydration, hyponatraemia, hyperkalaemia, etc.

Therapeutic uses of glucocorticoids

Endocrinal uses

1. **Acute adrenal insufficiency:** It is a medical emergency. It is treated with i.v. hydrocortisone and i.v. normal saline with 5% glucose to correct fluid and electrolyte imbalance. Precipitating causes such as trauma, infection or haemorrhage should be treated.
2. **Chronic adrenal insufficiency:** Treated with oral hydrocortisone (two-third of the daily dose is given in the morning and one-third in the evening) along with adequate salt and water.

Nonendocrinal uses

Corticosteroids are one of the most important groups of drugs used clinically in a variety of diseases. Because of their dramatic symptomatic relief, they are often misused. Nonendocrinal diseases require

supraphysiological doses of steroid, which inevitably carries risk. The beneficial effects of glucocorticoids are mainly due to their antiinflammatory and immunosuppressant effects.

1. **In dentistry:**

Topical or systemic glucocorticoids are used in:

- a. Recurrent aphthous stomatitis
- b. Chronic ulcerative stomatitis
- c. Oral pemphigoid
- d. Erythema multiforme
- e. Temporomandibular joint pain: Intra-articular triamcinolone is used.

2. **Rheumatoid arthritis:** They produce an immediate and dramatic symptomatic relief in rheumatoid arthritis; but they do not halt the progression of the disease. Intra-articular injection is preferred only if one or two joints are involved. Steroid could be given as an adjunct to *nonsteroidal antiinflammatory drugs* (NSAIDs) and *disease-modifying antirheumatic drugs* (DMARDs).
3. **Osteoarthritis:** They are rarely used in osteoarthritis. Intra-articular injection is recommended for acute episodes.
4. **Rheumatic fever:** They produce more rapid symptomatic relief than aspirin and are indicated in cases with carditis and CCF. Prednisolone is given along with aspirin and should be continued until the erythrocyte sedimentation rate (ESR) comes to normal and then the steroid is tapered off gradually.
5. **Allergic diseases:** The manifestations of allergic diseases, such as hay fever, reactions to drugs, urticaria, contact dermatitis, angioneurotic oedema and anaphylaxis, can be suppressed by glucocorticoids; but they have a slow onset of action. Hence, severe reactions such as anaphylaxis and angioneurotic oedema require immediate therapy with adrenaline. In hay fever, serum sickness and mild allergic reactions, antihistamines are the preferred drugs.
6. **Bronchial asthma:** They have antiinflammatory and antiallergic effects; hence they reduce mucosal oedema and bronchial hyperirritability. In acute severe asthma, i.v. hydrocortisone is given along with nebulized β_2 -agonist and ipratropium bromide. If a chronic asthmatic needs steroid, it is better to give inhalational preparations like beclomethasone, budesonide or fluticasone because they cause minimal systemic adverse effects.
7. **Collagen diseases:** Collagen diseases such as polymyositis, polyarteritis nodosa, etc. can be controlled with large doses of glucocorticoids. Steroids with negligible salt and water retaining property is preferred.
8. **Renal disease:** Glucocorticoids are the first-line drugs in nephrotic syndrome.
9. **Ocular diseases:** They are frequently used to suppress inflammation in the eye; thus they prevent damage to vision. Agents may be administered topically, subconjunctivally, systemically or by retrobulbar injection, depending upon the condition. Steroids are contraindicated in herpes simplex keratitis and ocular injuries.
10. **Skin diseases:** They dramatically relieve itching, pain, and inflammation in allergic and other dermatoses. To minimize systemic effects, topical steroids are preferred. Systemic steroid therapy is needed in severe conditions like exfoliative dermatitis, dermatomyositis, pemphigus, etc. Psoriasis, keloids and hypertrophic scar are sometimes treated by intralesional injection of steroids.
11. **Haematological disorders:** Autoimmune haemolytic anaemias usually respond to glucocorticoids. Because of their lympholytic action, glucocorticoids are used to treat certain malignancies, leukaemia, lymphomas, Hodgkin's disease, multiple myeloma, etc., usually in combination with antineoplastic drugs.

12. **Cerebral oedema:** The effectiveness of glucocorticoids in cerebral oedema depends upon the underlying cause. They are very effective when the oedema is caused by brain tumours, metastatic lesions and tubercular meningitis. A steroid without salt and water retaining activity (e.g. dexamethasone) is preferred.
13. **Intestinal diseases:** They are used in ulcerative colitis when the patient is not responding to other forms of treatment. Methylprednisolone can be administered as retention enema during acute episodes.
14. **Shock:** Prompt intensive treatment with i.v. glucocorticoids may be life saving in septic shock.
15. **Organ transplantation:** Glucocorticoids are used to prevent as well as treat graft rejections.
16. **Hypercalcaemia** of malignant diseases, and vitamin D intoxication responds to prednisolone.
17. **Other uses** include Bell's palsy and acute polyneuritis.

Relative contraindications for the use of corticosteroids

- | | |
|-----------------------------|-------------------------------|
| 1. Hypertension | 7. Epilepsy |
| 2. Diabetes mellitus | 8. Psychosis |
| 3. Peptic ulcer | 9. Congestive cardiac failure |
| 4. Tuberculosis | 10. Renal failure |
| 5. Herpes simplex keratitis | 11. Glaucoma |
| 6. Osteoporosis | |

Key Points for Dentists

- Prophylactic antibiotics are required before dental procedures for patients on long-term glucocorticoid therapy, as they are more prone for infection.
- In patients on glucocorticoid therapy, the preferred analgesic is paracetamol.
- Wound healing is impaired in patients on long-term glucocorticoid therapy.
- Abrupt stoppage of glucocorticoid therapy is dangerous after a prolonged course, as it may precipitate acute adrenal insufficiency on exposure to stress.

INSULIN AND ORAL ANTIDIABETIC AGENTS

Diabetes mellitus (DM) is a clinical syndrome characterized by hyperglycaemia due to absolute or relative deficiency of insulin. Lack of insulin affects the metabolism of carbohydrate, protein and fat.

Type 1 diabetes mellitus: It appears when more than 90% of β cells of pancreas are destroyed by an autoimmune process. The onset is acute and the peak incidence is around 15 years. In type-1 DM, there is insulin deficiency. Insulin is essential for all patients with type-1 DM. The aetiology is immunological or idiopathic.

Type 2 diabetes mellitus: Genetic influence is much more powerful in type-2 DM. It is the commonest form of diabetes. Overeating, obesity, underactivity and ageing are the main risk factors. Type-2 DM is associated with increased hepatic production of glucose and resistance of target tissues to the action of insulin.

Hormones of pancreas: There are four types of cells in islets of Langerhans: β (B) cells secrete insulin, α (A) cells secrete glucagon, δ (D) cells secrete somatostatin, and F (PP) cells secrete pancreatic polypeptide.

■ Insulin

Insulin was discovered by Banting and Best. It consists of two peptide chains, chain A and chain B (Fig. 10.6). These two chains are connected by two disulphide bridges. C-peptide (connecting peptide) can produce immunogenic reactions.

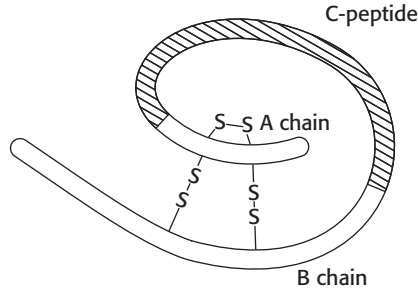

Fig. 10.6 Structure of proinsulin.

Insulin is synthesized by the β cells of pancreatic islets from a single-chain polypeptide precursor called preproinsulin, which is converted to proinsulin. Insulin is formed by the removal of the C-peptide from proinsulin by proteolysis.

Regulation of insulin secretion

Insulin secretion is regulated by chemical, neural and hormonal mechanisms.

- **Chemical:** Glucose, amino acids and fatty acids in the blood stimulate β cell to release insulin (Fig. 10.7).
- **Neural:** Both parasympathetic and sympathetic fibres supply the islet cells. Parasympathetic stimulation causes increase in insulin secretion and lowers raised blood sugar level. The islet cells have both α -adrenergic and β -adrenergic receptors. Adrenergic β_2 stimulation increases insulin release and the blood sugar falls. Adrenergic α_2 activation causes hyperglycaemia by inhibiting the release of insulin (Fig. 10.7).

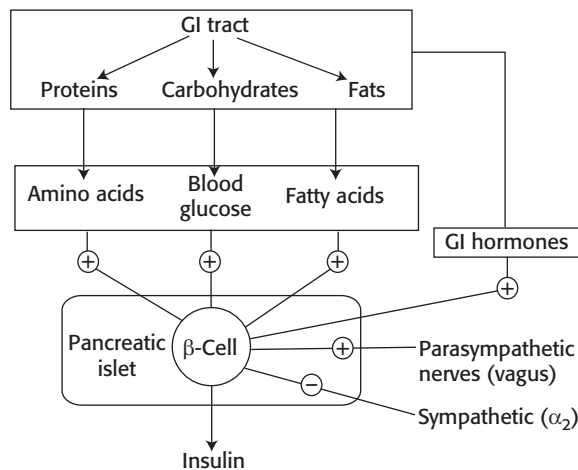

Fig. 10.7 Regulation of insulin secretion.

- **Hormonal:** GLP-1 (glucagon-like peptide), GIP (GI inhibitory peptide), gastrin, secretin, cholecystokinin, etc. promote the secretion of insulin (Fig. 10.8).

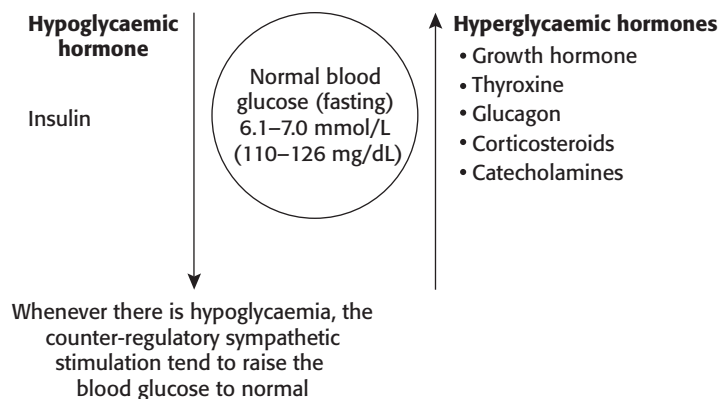

Fig. 10.8 Effect of various hormones on blood glucose level.

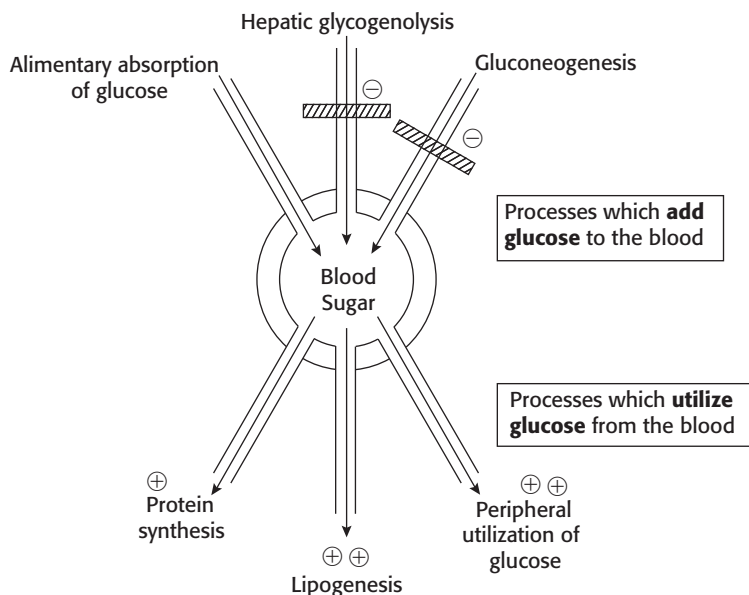

Fig. 10.9 Actions of insulin. ⊕, stimulation; ⊖, inhibition.

Actions of insulin (Fig. 10.9)

Insulin has profound effects on the metabolism of carbohydrate, fat and protein. Insulin facilitates the entry of glucose into all cells of the body. However, entry of glucose into red blood cells (RBCs), white blood cells (WBCs), liver and brain cells can occur independent of insulin. Muscular exercise also facilitates entry of glucose into muscle cells without the need for insulin.

1. Insulin inhibits hepatic glycogenolysis, gluconeogenesis and lipolysis in adipose tissue.
2. Insulin promotes protein synthesis in muscle, lipogenesis, hepatic and muscle glycogenesis.
3. Insulin also promotes peripheral utilization of glucose and K^+ uptake into the cells.

In diabetes, there is an actual or functional deficiency of insulin; therefore, hyperglycaemia occurs.

Mechanism of action of insulin

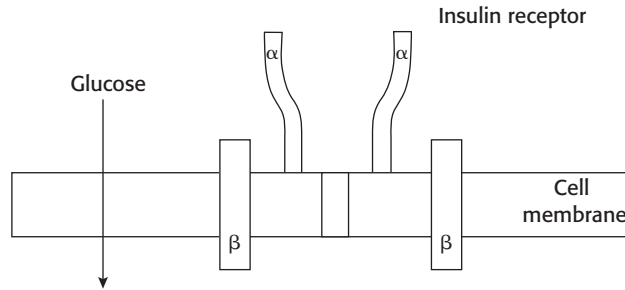

Fig. 10.10 Mechanism of action of insulin.

Insulin binds to specific receptors (receptor tyrosine kinase) present on the cell membrane. The receptor consists of 2 α and 2 β subunits (Fig. 10.10). Binding of insulin to the receptor activates tyrosine kinase of the receptor. A complex series of events occur resulting in various actions of insulin.

Pharmacokinetics

Insulin is destroyed by proteolytic enzymes in the gut and, hence, is not effective orally. Insulin is administered usually by subcutaneous (s.c.) route; but in emergencies, regular (soluble) insulin is given by i.v. route. After i.v. injection, soluble insulin is rapidly metabolized by the liver and kidney with a half-life of about 6 min.

Insulin Preparations

Conventional insulin preparations

- *Bovine (beef) insulin*: It differs from human insulin by three amino acid residues and is antigenic to man.
- *Porcine (pig) insulin*: It differs from human insulin by only one amino acid residue and is less immunogenic.

Monocomponent insulins

Conventional insulin preparations obtained from beef and pork pancreas (bovine and porcine insulin, respectively) are immunogenic. These preparations contain pancreatic proteins, proinsulin, insulin fragments, etc.

Conventional porcine insulin $\xrightarrow{\text{Purification techniques}}$ Monocomponent pork insulin

Monocomponent insulins are purified insulins. They are less antigenic than conventional preparations, cause less insulin resistance and lipodystrophy at injection site.

- **Human insulins**: They are produced by recombinant DNA technology using *E.coli* or yeast. They are least immunogenic; insulin resistance and lipodystrophy at the site of injection are rare, e.g. human regular insulin, human neutral protamine hagedorn (NPH) insulin, etc. Purified human insulins are the commonly used insulin preparations.

(Purified insulins: Insulin preparations with <10 ppm proinsulin contamination)

Insulin preparations based on onset and duration of action have been listed in Table 10.4.

- *Regular (soluble insulin)*:
 - Short acting, soluble, crystalline zinc insulin.

Table 10.4 Insulin Preparations Based on Onset and Duration of Action

Class	Type	Onset	Peak effect (h)	Duration of action (h)	
I.	Ultra-short-acting insulins	1. Insulin lispro 2. Insulin aspart 3. Insulin glulisine	0.25 (15 min) 0.25 (15 min) 5–15 min	1–1.5 1–1.5 1–2	3–4 3–4 3–4
II.	Short-acting insulin	Regular soluble insulin (crystalline)	0.5–1 h	2–4	6–8
III.	Intermediate acting insulin	NPH [†] (isophane)	1–2 h	6–10	10–20
IV.	Long-acting insulins	1. Insulin glargine 2. Insulin detemir	2–5 h 1–4 h	–* –*	20–24 20–24

[†]NPH, neutral protamine Hagedorn.

*Peak is minimal.

- Forms hexamers; after s.c. injection, it is slowly absorbed → onset of action is within 30 min; administered 30–45 min before meals.
- Duration of action is 6–8 h.
- Available as 40,100 and 500 U/mL.
- *NPH (neutral protamine hagedorn) insulin or isophane insulin*
 - Intermediate acting insulin.
 - Insulin complexed with protamine and zinc; dissociates slowly on s.c. administration → onset of action is delayed and duration of action is 10–20 h.
 - Cloudy solution.
 - Given once or twice daily.
- **Insulin analogues:** They are produced by DNA recombinant technology. They are obtained following alteration of amino acid sequence of human insulin. For example, rapidly acting insulin analogues and long acting insulin analogues.
 - *Rapidly acting insulin analogues* (modification in the B chain): e.g. insulin lispro, insulin aspart and insulin glulisine.
 - They have less tendency to form hexamers (unlike regular insulin).
 - On s.c. administration: Quickly dissociate into monomers → rapidly absorbed → rapid onset of action within 5–15 min; peak effect in 1 h. They are administered just before meals.
 - Duration of action is about 4 h; lower risk of late postprandial hypoglycemia.
 - Immunogenicity and binding to insulin receptor is similar to human regular insulin.
 - *Long-acting insulin analogues*, e.g. insulin glargine and insulin detemir.
 - *Insulin glargine*
 - On s.c. administration: slowly absorbed → delayed onset of action with ‘peakless’ plasma concentration.
 - Administered once daily.
 - Cannot be mixed with other human insulins because of its acidic pH.
 - Lower risk of nocturnal hypoglycemia than NPH insulin.

- Fasting blood glucose levels are better controlled than NPH insulin.
- Should be avoided in pregnant diabetics.

Insulin detemir

- On s.c. injection: binds to albumin in blood → prolonged duration of action.
- Minimal peak level.
- Usually given twice daily.

Insulin therapy

Insulin is the main drug for all patients with type-1 DM, and for patients with type-2 DM who are not controlled by diet and oral antidiabetic drugs. The main goal of insulin therapy is to maintain the fasting blood glucose concentration between 90 and 120 mg/dL and postprandial glucose level below 150 mg/dL.

Concentration of insulin

Insulin preparations are available in a concentration of 100 or 40 U/mL. Regular insulin is also available in 500 U/mL. Insulin dosage is measured in units (U). All insulin preparations are administered by s.c. route. Regular insulin can be given by i.v. route in diabetic ketoacidosis to obtain a rapid effect.

Insulin regimen

Various regimens of mixture of insulins are used for therapy. A convenient regimen for insulin therapy is the split-mixed regimen—often, a split dose of 70:30 NPH/regular insulin mixture is administered before breakfast and dinner. If blood glucose levels are not adequately controlled, multiple insulin injections are required. Another regimen is basal-bolus regimen—a long-acting insulin either before breakfast or at bedtime (once daily) and preprandial injection of rapid acting insulin. Long-acting insulins maintain basal insulin levels; preprandial insulin provides postprandial needs of insulin.

Mixed insulin preparations

Intermediate-acting insulin takes several hours to achieve effective plasma concentration. Hence, they are combined with regular insulin/rapidly acting insulin analogues. For example, NPH (intermediate acting insulin) + regular/rapidly acting insulin analogues (insulin lispro and aspart) in the ratio of 70:30. They can be mixed in the same syringe.

Insulin administration

- Insulin syringes and needles.
- Pen devices: They are convenient to carry; a preset amount is delivered subcutaneously.
- Insulin pumps are available for continuous subcutaneous insulin infusion. Short acting insulin, e.g. regular insulin is used. An advantage is that it is programmed to deliver insulin to maintain basal levels and also a bolus dose prior to meals. It is expensive and there could be mechanical problems with the pump.

Indications for insulin

1. Type 1 diabetes mellitus.
2. Diabetic ketoacidosis.
3. Diabetes during pregnancy.
4. Stress of surgery, infections and trauma (temporarily to tide over trauma, infection, surgery, etc.).
5. Patients with type 2 DM unresponsive to oral antidiabetic drugs.

Site of administration

Insulin is usually administered subcutaneously in the abdomen, buttock, anterior thigh or dorsal arm.

Complications of insulin therapy

1. **Hypoglycaemia** is the most common and dangerous complication. Prolonged hypoglycaemia may cause permanent brain damage. Hypoglycaemia can occur in any diabetic and may be due to delay in taking food, too much physical activity or excess dose of insulin.

Symptoms of hypoglycaemia are:

- a. *Autonomic symptoms*: They occur initially and are due to counter-regulatory sympathetic stimulation—sweating, tremor, palpitation, anxiety and tachycardia.
- b. *Neuroglycopenic symptoms* like headache, blurred vision, confusion, loss of fine motor skill and abnormal behavior. They usually occur at lower plasma glucose levels.

With further lowering of blood glucose levels, convulsions and loss of consciousness can occur.

Treatment: All these manifestations are relieved by administration of glucose. If the patient is conscious, oral glucose or if the hypoglycaemia is severe (unconscious patient) 50 mL of 50% dextrose is injected intravenously.

Glucagon 1 mg i.v. or adrenaline 0.2 mg s.c. may be given for severe hypoglycaemia.

2. **Allergic reactions** are rare; local skin reactions (swelling, redness) at the site of injection can occur, which may be due to minor contaminants.
3. **Lipodystrophy** (either atrophy or hypertrophy) may occur at the site of injection. It may be avoided by using purified insulin preparations and changing the injection site by rotation.
4. **Insulin resistance:** It is a state in which patient requires more than 200 U of insulin/day and is common among obese type-2 diabetics. It may be acute or chronic. Acute insulin resistance develops rapidly and is due to stressful conditions like trauma, infection, surgery, psychological stress, etc. Chronic insulin resistance is common in patients on prolonged conventional beef or pork insulins. Such patients should be treated with highly purified insulins.
5. **Oedema** due to salt and water retention.

Diabetic ketoacidosis

Diabetic ketoacidosis is a complication of Type 1 diabetes mellitus. It is very rare in Type 2 DM. The common precipitating factors are infection, trauma, severe stress, etc. The clinical features are anorexia, nausea, vomiting, polyuria, abdominal pain, hypotension, tachycardia, hyperventilation, altered consciousness or coma in untreated cases. Diabetic ketoacidosis is a medical emergency. It is treated with regular insulin (i.v.); correction of fluid and electrolyte imbalance is essential.

Drug interactions

1. **β -Blockers** \times **insulin** (see pp. 93 and 94).
2. **Salicylates** \times **insulin**: Salicylates exert hypoglycaemic effect by increasing the sensitivity of pancreatic β -cells to glucose and potentiating insulin secretion.

Oral Antidiabetic Drugs (Table 10.5)

1. **Sulfonylureas**
 - a. **First generation**: Tolbutamide, chlorpropamide.
 - b. **Second generation**: Glyburide (glibenclamide), glipizide, gliclazide, glimepiride.
2. **Biguanides**: Metformin.
3. **Meglitinide analogue**: Repaglinide.
4. **D-phenylalanine derivative**: Nateglinide.

5. **Thiazolidinediones:** Pioglitazone.
 6. **α -Glucosidase inhibitors:** Acarbose, miglitol.

Newer antidiabetic agents

- **GLP-1 receptor agonist:** Exenatide.
- **DPP-4 inhibitors:** Sitagliptin.

Sulfonylureas, meglitinides and D-phenylalanine derivatives are insulin secretagogues.

Table 10.5 Oral and Newer Antidiabetic Drugs: Dosage and Duration of Action

Drug	Daily Dose	Duration of Action (h)	Other Points
I. Sulfonylureas (given half an hour before food)			
• Tolbutamide	0.5–2 g, in two or three divided doses	6–12	Short acting, low potency and least likely to cause hypoglycaemia
• Chlorpropamide	0.1–0.5 g, as a single dose	48–72	Incidence of hypoglycaemia is more because of long duration of action, has disulphiram-like action, increases the release of ADH and, hence, useful in neurogenic diabetes insipidus
• Glibenclamide (glyburide)	1.25–20 mg, single or two divided doses	12–24	Hypoglycaemia is common because of longer duration of action. The active metabolite accumulates in renal failure
• Gliclazide	40–320 mg, single or in two divided doses	12–24	It is a commonly used second-generation sulfonylurea
• Glipizide	5–40 mg, one to two doses	12–18	Shorter acting, lower potency and is preferred in elderly patients
• Glimepiride	1–8 mg, single dose	Up to 24	Used once daily as monotherapy or in combination with insulin. It causes less hypoglycaemia than glibenclamide
II. Biguanides			
• Metformin	500 mg three times daily, given with food (maximum dose is 2.5 g/day)	8–12	Metformin is used in patients with type-2 DM, either alone or in combination with sulfonylurea/insulin. Metformin is not used in patients with type-1 DM and is contraindicated in patients with hepatic insufficiency and alcoholism. Lactic acidosis is rare
III. Meglitinide analogue			
• Repaglinide	0.25–4 mg in two divided doses, given 15 min before breakfast and dinner	3	Repaglinide can be used in combination with metformin. Less hypoglycaemia because of short duration of action. It may be useful in patients with renal impairment or in the elderly

(Contd...)

Table 10.5 (Contd...)

Drug	Daily Dose	Duration of Action (h)	Other Points
IV. D-Phenylalanine derivative			
• Nateglinide	60–120 mg t.d.s., given just before food	2–4	Has short duration of action. Side effects are hypoglycaemia and weight gain
V. Thiazolidinediones			
• Pioglitazone	15–45 mg daily	Up to 24	Cause fluid retention and precipitation of CCF. The drug should be avoided in patients with liver and heart disease
VI. α-Glucosidase inhibitors			
• Acarbose	50 mg b.d. gradually increased to 100 mg t.d.s just before food	4	Side effects are flatulence, fullness and diarrhoea
VII. DPP-4 inhibitor			
• Sitagliptin	Oral, 100 mg once daily	24	Can cause allergic reactions
	Oral, 2.5 mg/5 mg once daily	24	

■ Sulfonylureas

Sulfonylureas are divided into two generations. All these drugs have the same mechanism of action, but differ in potency and duration of action. The second-generation drugs are more potent than first-generation drugs.

Mechanism of action

1. Sulfonylureas stimulate insulin secretion from β cells of pancreas. It is an insulin secretagogue.

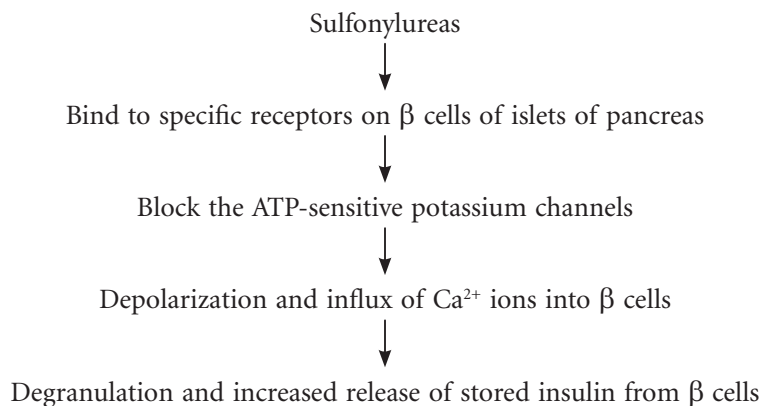

For successful therapy with sulfonylureas, at least 30% functioning β cells are necessary. Sulfonylureas are ineffective in type-1 DM because of absence of functioning β cells in the islets of pancreas.

2. Sulfonylureas increase the sensitivity of peripheral tissues to insulin by increasing the number of insulin receptors.
3. They reduce the release of glucagon.

Pharmacokinetics

Sulfonylureas are well absorbed after oral administration, highly bound to plasma proteins and have low volume of distribution. They are metabolized in liver and excreted mainly in urine.

Adverse effects

1. Hypoglycaemia is common, particularly with glibenclamide and chlorpropamide due to their long duration of action. Glibenclamide is best avoided in elderly patients because of the high risk of hypoglycaemia.
2. GI disturbances like nausea, vomiting, diarrhoea and flatulence.
3. Weight gain is due to stimulation of appetite.
4. Allergic reactions: Skin rashes, itching and photosensitivity.
5. Teratogenicity: Sulfonylureas are not safe during pregnancy.
6. Chlorpropamide has disulfiram-like action and, hence, produces intolerance to alcohol.

Use

Sulfonylureas are useful in patients with type 2 diabetes mellitus.

Drug interactions

1. **Sulfonylureas** \times **salicylates/sulphonamides**: These drugs are highly bound to plasma proteins and displace sulfonylureas from the plasma protein-binding site—resulting in an increase in free plasma concentration of sulfonylureas—potentiate the effects of sulfonylureas (severe hypoglycaemia).
2. **Propranolol** \times **sulfonylureas**: Propranolol by blocking hepatic β_2 -receptors inhibits glycogenolysis and delays recovery from hypoglycaemia. Propranolol also masks the symptoms of sulfonylurea induced hypoglycaemia, such as tachycardia, palpitation, etc. by blocking β_1 -receptors of the heart and tremors by blocking β_2 -receptors in the skeletal muscle.
3. **Rifampicin, phenobarbitone** \times **sulfonylureas**: Rifampicin and phenobarbitone are enzyme inducers; hence, they accelerate the metabolism of sulfonylureas and reduce their effects.
4. **Warfarin, sulphonamides** \times **sulfonylureas**: They inhibit the metabolism of sulfonylureas and, thereby, increase the plasma levels of sulfonylureas leading to severe hypoglycaemia.

Biguanides

Metformin is the only biguanide used clinically.

Mechanism of action

The mechanism of action of biguanides is shown in Figure 10.11. It is as follows.

Biguanides:

1. inhibit hepatic gluconeogenesis.
2. inhibit alimentary absorption of glucose.
3. increase peripheral utilization of glucose and decrease lipogenesis in adipose tissue.

Biguanides do not affect insulin release. It does not cause weight gain.

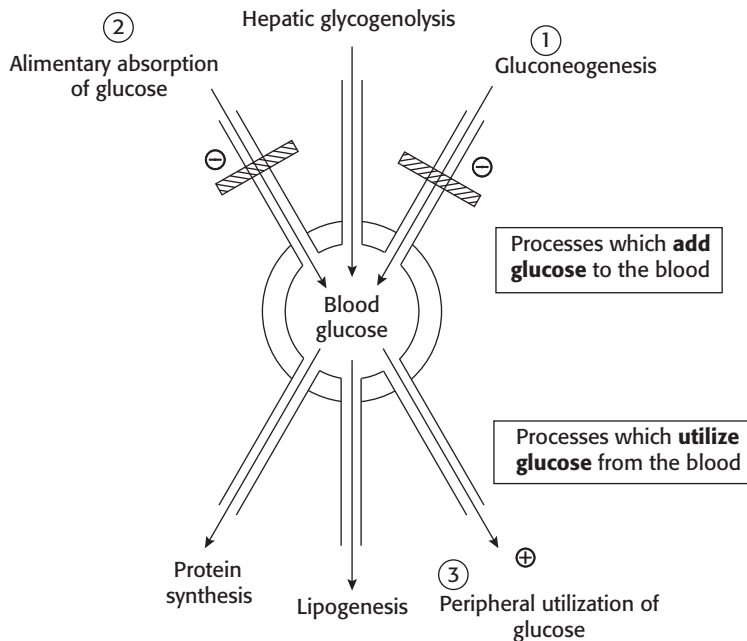

Fig. 10.11 Mechanism of action of biguanides. ⊕, Stimulation; ⊖, inhibition.

Pharmacokinetics

Metformin is taken orally, well absorbed through GI tract and is excreted mostly unchanged in urine.

Adverse effects

Adverse effects are metallic taste, anorexia, nausea, vomiting, diarrhoea and skin rashes. Lactic acidosis is the most serious complication, but is rare with metformin. Prolonged use can cause vitamin B₁₂ deficiency due to malabsorption. Metformin usually does not cause hypoglycaemia even in large doses.

Use

Metformin is a commonly used first-line drug for the treatment of type 2 DM. It can be used alone or in combination with other antidiabetic agents.

■ Meglitinide Analogue (Repaglinide) and D-Phenylalanine Derivative (Nateglinide)

Repaglinide and nateglinide are structurally unrelated to sulfonylureas, but their mechanism of action is similar to sulfonylureas. They stimulate insulin release by closure of ATP-sensitive potassium channels in β cells of islets of pancreas \rightarrow depolarization \rightarrow insulin release. Repaglinide and nateglinide are well absorbed from GI tract, metabolized mainly in the liver and should be avoided in patients with hepatic failure. They have rapid onset but short duration of action. They are less potent than sulfonylureas. They are used only in type-2 DM to control postprandial hyperglycaemia.

The main side effects of repaglinide are weight gain and hypoglycaemia, but the episodes are less frequent; meglitinide causes nausea and flu-like symptoms.

■ Thiazolidinediones

They increase sensitivity of peripheral tissues to insulin.

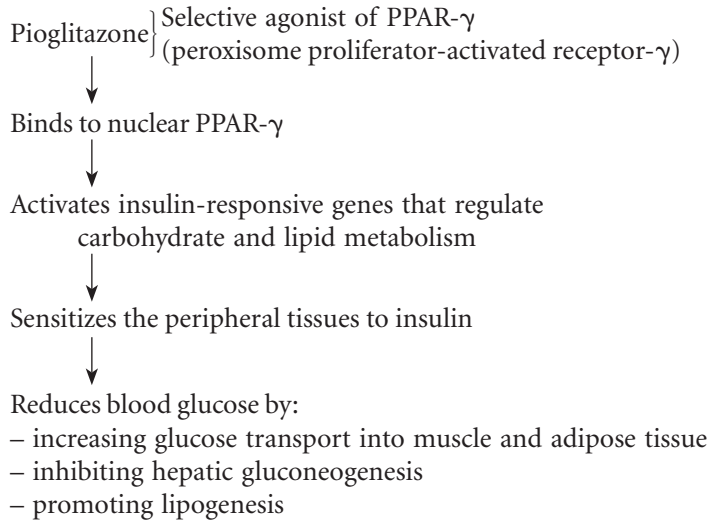

Other actions: Pioglitazone reduces serum triglyceride and increases HDL levels.

Pharmacokinetics

Pioglitazone is almost completely absorbed from GI tract, highly bound to plasma proteins (95%) and metabolized in the liver.

Adverse effects

Nausea, vomiting, anaemia, weight gain, oedema and precipitation of heart failure in patients with low cardiac reserve; rarely hepatotoxicity has been reported.

Use

Pioglitazone is used alone or in combination with sulfonylureas/metformin in patients with type-2 diabetes mellitus.

▀ α -Glucosidase Inhibitors

These drugs should be given just before food.

Acarbose, miglitol and voglibose

They reduce intestinal absorption of carbohydrates by inhibiting the enzyme α -glucosidase in the brush border of the small intestine and reduce postprandial hyperglycaemia. They are mainly used in obese type-2 DM patients. Side effects are mainly on GI tract: flatulence, fullness and diarrhoea.

▀ Newer Drugs

GLP-1 receptor agonists, e.g. exenatide

Glucagon like peptide-1 (GLP-1) is released from the gut after meals. It stimulates insulin secretion, suppresses glucagon release and slows gastric emptying. It is degraded by dipeptidyl peptidase 4 (DPP-4); its plasma half-life is 1–2 minutes. GLP-1 receptor agonists, e.g. exenatide, are resistant to DPP-4. Their actions are similar to GLP-1. It is used in patients with type-2 diabetes mellitus.

DPP-4 (dipeptidyl peptidase-4) inhibitors, e.g. sitagliptin, saxagliptin

They inhibit the enzyme DPP-4 → prevent inactivation of GLP-1 → increase plasma concentration of GLP-1 → increases insulin secretion, suppresses glucagon release, slows gastric emptying and improves

control of postprandial hyperglycemia. They are administered orally in patients with type 2 diabetes mellitus. Allergic reactions can occur with sitagliptin. Respiratory and urinary tract infection may be seen with saxagliptin.

Key Points for Dentists

- ➔ Diabetics usually require prophylactic antibiotics before any dental procedures.
- ➔ Educate the patient about diet, exercise and drugs.
- ➔ Educate the patient about symptoms of hypoglycaemia.
- ➔ Educate the patient about monitoring their own blood sugar level and self-administration of insulin.
- ➔ The site of insulin injection should be changed by rotation.

AGENTS AFFECTING CALCIUM BALANCE

■ Calcium

About 99% of calcium of our body is in bone and teeth. Calcium metabolism is chiefly regulated by three hormones: parathormone (PTH), vitamin D (dihydrocholecalciferol) and calcitonin. Parathormone plays a central role in regulating calcium homeostasis. Calcium metabolism is also intimately connected with phosphorus and magnesium metabolism. The normal serum calcium level is 9–11 mg/dL.

Functions of calcium

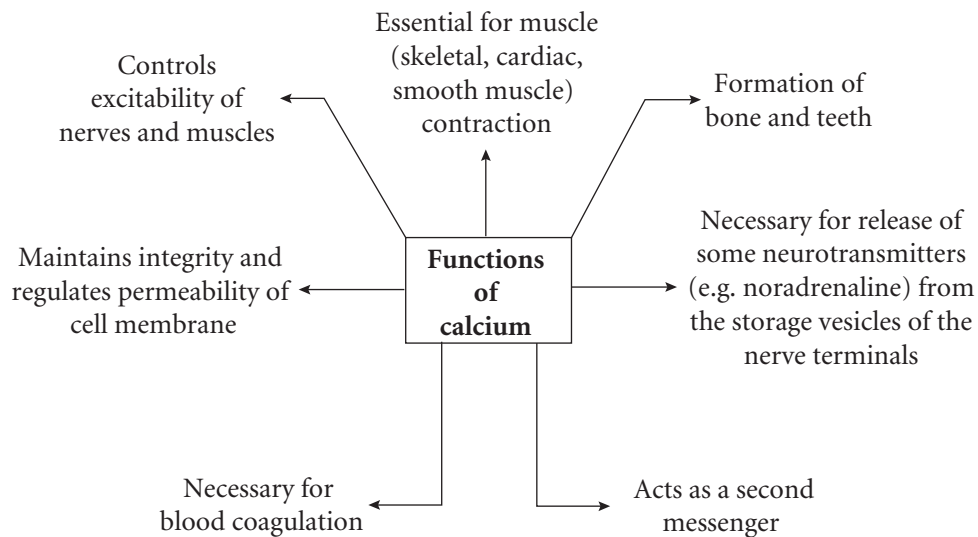

Preparations of calcium

- **Oral:** Calcium gluconate, calcium citrate, calcium lactate and calcium carbonate. Calcium carbonate is cheap, tasteless and is preferred because of its high percentage of calcium.
- **Parenteral:**
 - *Intravenous calcium gluconate:* Nonirritant, hence it is preferred.
 - *Intravenous calcium chloride:* Highly irritant and causes tissue necrosis.

Therapeutic uses of calcium salts

1. *To correct calcium deficiency:*

- a. In growing children, pregnant and lactating women.
 - b. In dietary deficiency.
 - c. In postmenopausal osteoporosis.
 - d. In rickets and osteomalacia along with vitamin D.
 - e. In long-term corticosteroid therapy along with vitamin D.
 - f. After removal of parathyroid tumour.
2. Intravenous calcium gluconate (10%) in **tetany**.
 3. Calcium carbonate is used **as antacid**.

■ Parathyroid Hormone (PTH)

Parathormone is a polypeptide hormone, which is synthesized by the chief cells of the parathyroid gland. PTH secretion is chiefly controlled by the concentration of free Ca^{2+} in plasma—low plasma Ca^{2+} stimulates secretion and vice versa.

Actions of PTH

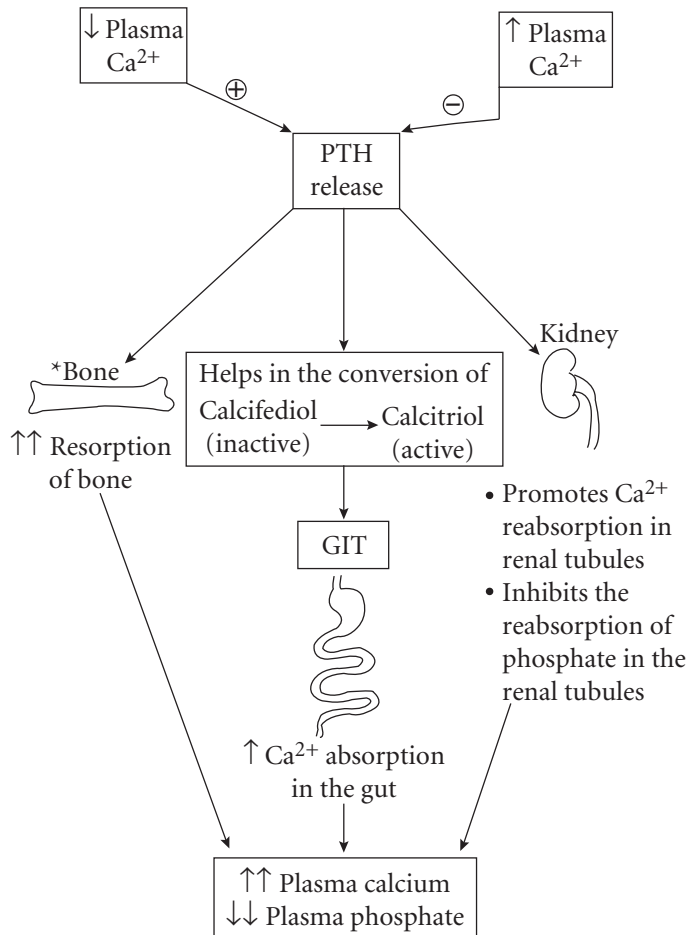

*Low intermittent doses of PTH stimulates bone formation.

▮ Hypoparathyroidism (Deficiency of Parathyroid Hormone)

Serum calcium levels are decreased.

Treatment

1. *Emergency treatment of acute attack (hypoparathyroid tetany)*
 - a. 10% i.v. calcium gluconate given slowly until tetany ceases.
 - b. Oral calcium salts should be started as soon as possible.
2. *Treatment of chronic hypoparathyroidism*
 - a. The treatment of choice is vitamin D₂ (ergocalciferol).
 - b. Oral calcium salts should be started as soon as possible.

Teriparatide

- Recombinant preparation of PTH.
- Route: Administered subcutaneously, once daily.
- Stimulates bone formation.
- Use: Treatment of severe osteoporosis—improves bone mineral density.
- Expensive.

▮ Hyperparathyroidism

Hyperparathyroidism is characterized by increased levels of parathormone, often due to parathyroid tumour. There is hypercalcaemia and hypercalciuria. Some of the cases of hyperparathyroidism can be treated with cinacalcet, which acts on parathyroid gland to decrease PTH secretion.

Treatment

Surgical removal of the parathyroid tumour.

■ Calcitonin

Calcitonin is synthesized by the 'C' cells of the thyroid. It is a peptide hormone. The main actions of calcitonin are to lower serum calcium and phosphate by direct action on bone and kidney. Calcitonin secretion is stimulated when the serum calcium level becomes high and vice versa.

Actions of calcitonin (generally opposite to that of PTH)

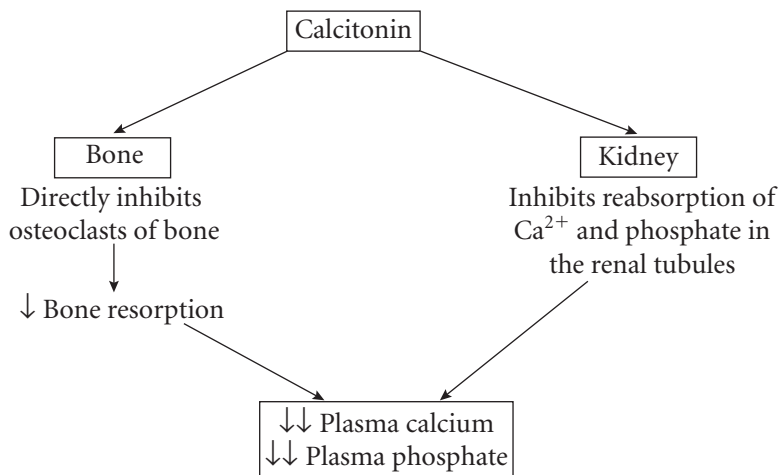

Preparations of calcitonin

1. Porcine (natural) calcitonin—antigenic—can lead to the production of antibodies.
2. Synthetic salmon calcitonin.
3. Synthetic human calcitonin.

Calcitonin is given by s.c. or i.m. routes. Salmon calcitonin is also available as nasal spray.

Therapeutic uses

1. **In hypercalcaemic states** (e.g., associated with neoplasia).
2. **In Paget's disease of bone:** Chronic use of calcitonin relieves pain and reduces some of the neurological complications; but bisphosphonates are the treatment of choice.
3. **In postmenopausal osteoporosis and corticosteroid induced osteoporosis:** Salmon calcitonin is used as nasal spray along with calcium and vitamin D supplements.

Adverse effects

Nausea, vomiting, flushing and pain at the site of injection.

Vitamin D

Vitamin D is a fat-soluble vitamin. It is a prohormone, which is converted in the body into a number of biologically active metabolites that function as true hormone. Vitamin D, together with PTH, plays a central role in the maintenance of plasma calcium and bone formation. Vitamin D is found in fish liver oils and dairy products, and is also synthesized in the skin on exposure to sunlight.

Pathways of vitamin D production

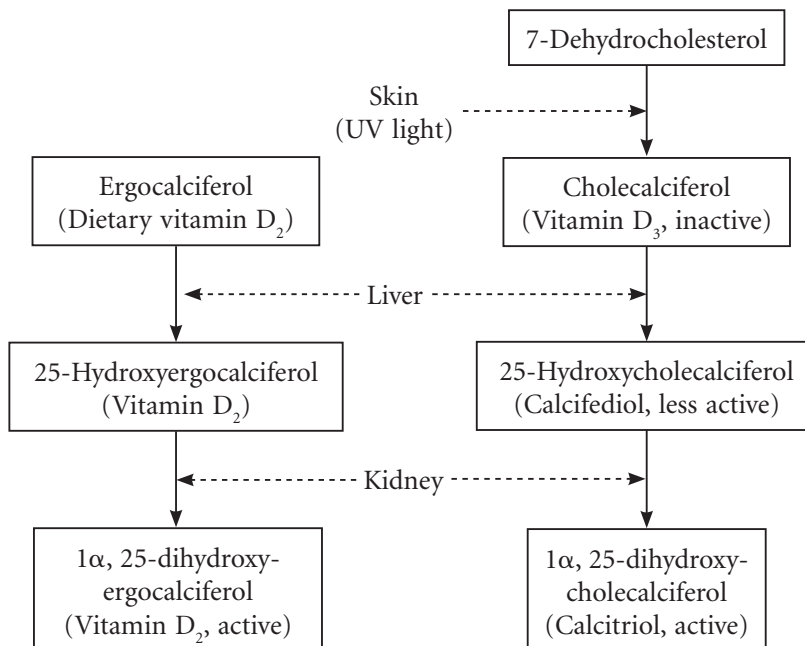

Actions of vitamin D

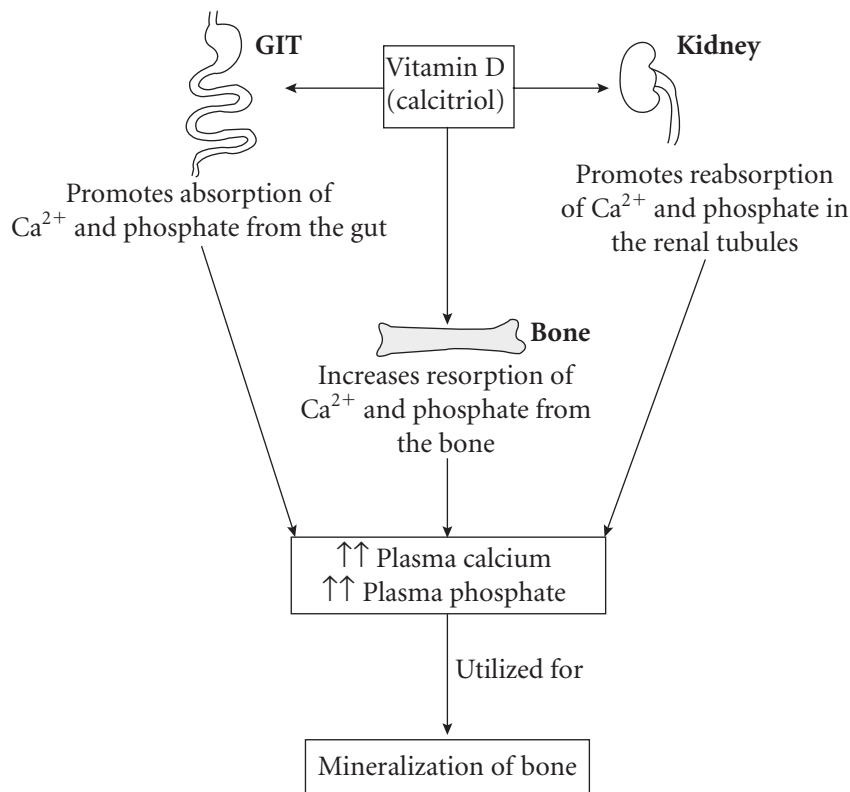

Vitamin D deficiency causes rickets in children and osteomalacia in adults. Hypervitaminosis D may occur due to acute large dose or long-term use of vitamin D. The signs and symptoms of hypercalcaemia are nausea, weakness, fatigue and polyuria. If hypercalcaemia persists, calcium salts are deposited in the kidney, resulting in renal failure and renal stones. Treatment includes immediate stoppage of vitamin D, low-calcium diet, intravenous hydration and administration of glucocorticoids.

Preparations of vitamin D

- **Ergocalciferol (vitamin D₂)**: Oral capsules 400 IU/day for prevention of rickets in children and osteomalacia in adults.
 - **Cholecalciferol (vitamin D₃)**: Oral and i.m. injection.
 - **Calcitriol**: Oral capsules and solution.
 - **Alfacalcidol**
 - **Dihydrotachysterol**
- } Prodrugs, orally effective, do not require activation in the kidney and are rapidly biotransformed into calcitriol in the liver. They are effective in renal bone disease and hypoparathyroidism.

Therapeutic uses of vitamin D

1. Prevention (400 IU/day) and treatment (4000 IU/day) of **nutritional rickets** and **osteomalacia**.
2. **Vitamin D-resistant rickets and osteomalacia**: They are disorders of calcium and phosphate metabolism. They are treated with large doses of vitamin D and phosphate.
3. **Vitamin D-dependent rickets**: It is an inborn error of vitamin D metabolism. There is a failure of conversion of calcifediol to calcitriol. It responds to calcitriol or alfacalcidol.

4. **Renal rickets:** It is associated with chronic renal failure; hence the conversion of calcifediol to calcitriol does not occur. It is treated with calcitriol or alfacalcidol.
5. In **hypoparathyroidism**, there is hypocalcaemia and hyperphosphataemia. Calcitriol or alfacalcidol are effective for temporary treatment of hypocalcaemia.
6. Administration of vitamin D with calcium in **senile or postmenopausal osteoporosis** improves calcium balance and may reduce the risk of fractures.

Key Points for Dentists

↳ Intravenous calcium gluconate should be injected slowly.

BISPHOSPHONATES

Bisphosphonates are analogues of pyrophosphate. They are etidronate (oral, i.v.), alendronate (oral), pamidronate (i.v. infusion), zoledronate (i.v. infusion), risedronate (oral), etc.

Mechanism of action

Bisphosphonates exert antiresorptive effect. They:

- have high affinity for calcium in the bone → accumulate in areas of bone resorption → taken up by osteoclasts → promote their apoptosis.
- interfere with mevalonate pathway of cholesterol synthesis, which is required for normal function of osteoclasts.

Pharmacokinetics

Bisphosphonates are highly polar and, hence, poorly absorbed through GI tract; a part of the absorbed drug is incorporated into bone and remains for long from months to years. The free drug is excreted unchanged in urine.

Uses

1. **Paget's disease of bone:** Bisphosphonates are the treatment of choice for Paget's disease. They reduce bone pain and decrease alkaline phosphatase level.
2. **For prevention and treatment of postmenopausal osteoporosis:** These drugs improve bone mineral density and reduce incidence of vertebral fracture.
3. To prevent **corticosteroid induced osteoporosis** along with oral calcium carbonate.
4. **Hypercalcaemia of malignancy:** Bisphosphonates control hypercalcaemia by inhibiting bone resorption. Zoledronate is the most potent and is the drug of choice for malignant hypercalcaemia.
5. Bisphosphonates are also useful to control hypercalcaemia of **hyperparathyroidism**.
6. To relieve the pain of **lytic bone lesions**.

Adverse effects

They include nausea, vomiting, diarrhoea, heartburn, oesophagitis, peptic ulcer, fever, myalgia hypocalcaemia, headache and skin rashes. Oral bisphosphonates should be taken with plenty of water and the patient should remain upright for at least 30 minutes to prevent oesophagitis. Flu-like symptoms can occur on parenteral administration. Rarely, osteonecrosis of the jaw may occur.

Drugs useful in hypercalcemia: Bisphosphonates and mithramycin (inhibits bone resorption), glucocorticoids (↓ Ca²⁺ absorption and ↑ its excretion).

Key Points for Dentists

↳ Bisphosphonates can cause osteonecrosis of the jaw.

This page intentionally left blank

GENERAL CONSIDERATIONS

Chemotherapy	Chemotherapy is the treatment of infectious diseases or malignancy with drugs that destroy microorganisms or cancer cells preferentially with minimal damage to host tissues. The infection may be due to bacteria, virus, fungi, protozoa or helminths.
Antibiotics	Antibiotics are chemical substances obtained from microorganisms that kill or suppress growth of other microorganisms at a very low concentration.
Bactericidal agents	They kill or destroy microorganisms, e.g. penicillins, cephalosporins, aminoglycosides, etc.
Bacteriostatic agents	They inhibit the growth and multiplication of microorganisms, e.g. sulphonamides, tetracyclines, chloramphenicol, erythromycin, etc. At high concentration, some of the 'static' drugs may produce 'cidal' effect; for example, chloramphenicol is a bacteriostatic drug, but it may be bactericidal against <i>Haemophilus influenzae</i> , <i>Neisseria meningitidis</i> and <i>Streptococcus pneumoniae</i> .
Antimicrobial agents	Antimicrobial agents (AMAs) are synthetic as well as naturally obtained drugs that act against microorganisms.
Minimum inhibitory concentration	Minimum inhibitory concentration (MIC) is the minimum concentration of an antimicrobial agent that prevents visible growth of a microorganism.

■ Classification of Antimicrobial Agents

I. According to their type of action

a. *Bactericidal agents*

- Penicillins
- Cephalosporins
- Aminoglycosides
- Fluoroquinolones
- Rifampin
- Metronidazole

b. *Bacteriostatic agents*

- Tetracyclines
- Chloramphenicol
- Sulphonamides
- Dapsone
- Erythromycin
- Clindamycin

- II. According to their spectrum of activity
- Narrow-spectrum antibiotics**
 - Penicillin G
 - Aminoglycosides
 - Broad-spectrum antibiotics**
 - Tetracyclines
 - Chloramphenicol
- III. According to their mechanism of action (Fig. 11.1)
- Drugs that inhibit cell wall synthesis, e.g. penicillins, cephalosporins, carbapenems, bacitracin, vancomycin.
 - Drugs that affect cell membrane function, e.g. amphotericin B (AMB), nystatin, polymyxin.
 - Drugs that inhibit protein synthesis, e.g. chloramphenicol, tetracyclines, erythromycin, clindamycin.
 - Drugs that alter protein synthesis by misreading of mRNA code, e.g. aminoglycosides.
 - Drugs that inhibit DNA synthesis, e.g. acyclovir, ganciclovir, zidovudine.
 - Drugs that affect DNA function, e.g. rifampin, rifabutin, metronidazole.
 - Drugs that inhibit DNA gyrase, e.g. fluoroquinolones.
 - Antimetabolites, e.g. sulphonamides, dapsone, trimethoprim, pyrimethamine.

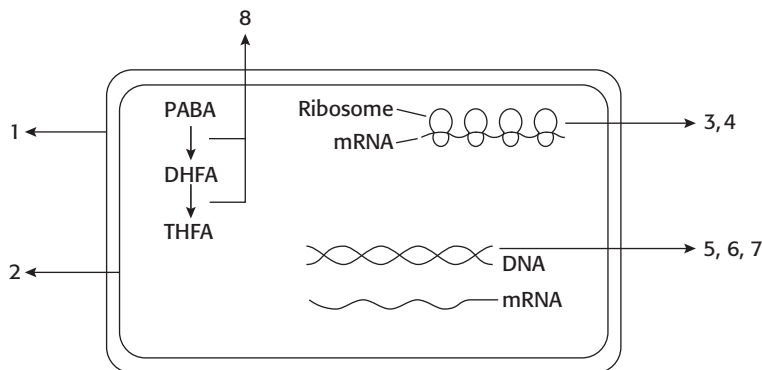

Fig. 11.1 Classification of antimicrobials based on their mechanism of action. PABA, para-aminobenzoic acid; DHFA, dihydrofolic acid; THFA, tetrahydrofolic acid.

■ Resistance to Antimicrobial Agents

Resistance is defined as the unresponsiveness of a microorganism to an antimicrobial agent (AMA). The resistance may be *natural* or *acquired*. The natural resistance is genetically determined, e.g. normally, gram-negative bacilli are not affected by penicillin G.

In acquired resistance, microbes that initially respond to an AMA later develop resistance to the same AMA by mutation or gene transfer, e.g. gonococcal resistance to penicillins. The transfer of genes for drug resistance occurs by the following mechanisms:

Transduction: There is transfer of DNA carrying a gene for resistance from one bacterium to another through bacteriophage, e.g. resistance of strains of *Staphylococcus aureus* to antibiotics is mediated via transduction.

Transformation: The resistance carrying genetic material that is released into the environment by resistant bacteria is taken up by other sensitive bacteria, e.g. penicillin G resistance in pneumococci.



Conjugation: Conjugation is the transfer of genetic material carrying resistance between bacteria by direct contact through sex pilus, e.g. *Escherichia coli* resistance to streptomycin.

Mechanism of development of resistance to antimicrobial agents

There are several mechanisms by which an organism can develop resistance to an antimicrobial agent. The important mechanisms are:

1. *Production of inactivating enzymes:* For example, staphylococci, gonococci, *E. coli*, etc. produce β -lactamases that can destroy some of the penicillins and cephalosporins.
2. *An efflux pump mechanism:* It is a mechanism that prevents the accumulation of the drug in the microorganism, e.g. resistance of gram-positive and gram-negative bacteria to tetracyclines, chloramphenicol, macrolides, etc.
3. *Alteration of the binding site:* For example, change in penicillin-binding proteins (PBPs) in case of certain pneumococci with decreased affinity for penicillins.
4. *Absence of metabolic pathway:* For example, sulphonamide-resistant bacteria can utilize preformed folic acid without the need for the usual metabolic steps.

Cross-resistance

Organisms that develop resistance to an antimicrobial agent may also show resistance to other chemically related AMAs. The cross-resistance among AMAs could either be one-way or two-way. Cross-resistance among tetracyclines and sulphonamides is usually 'two-way'.

Tetracycline \rightleftharpoons Doxycycline (tetracyclines)

Sulphadiazine \rightleftharpoons Sulphadoxine (sulphonamides)

The 'one-way' resistance is seen between neomycin and streptomycin. Neomycin-resistant organisms are resistant to streptomycin but streptomycin-resistant organisms may be sensitive to neomycin.

Neomycin \longrightarrow Streptomycin

Prevention of development of resistance to antimicrobial agents

It is done by:

1. Selecting right antimicrobial agent.
2. Giving right dose of the AMA for proper duration.
3. Proper combination of AMAs, e.g. in tuberculosis (TB), multidrug therapy (MDT) is used to prevent development of resistance to antitubercular drugs by mycobacteria.

■ Superinfection (Suprainfection)

It is defined as the appearance of a new infection due to antimicrobial therapy. The causative organism of superinfection should be different from that of the primary disease. Most of the AMAs—especially broad-spectrum antibiotics (tetracyclines, chloramphenicol), clindamycin, ampicillin, etc.—alter the normal bacterial flora, as a result of which the host-defence mechanism is impaired. Hence, pathogenic organisms invade the host, multiply and produce superinfection. The causative organism may be fungi or bacteria.

Pathogenesis

The pathogenesis of superinfection is depicted in Figure 11.2 (a-c). The sites involved in superinfection are those body cavities that have direct communication with the exterior, i.e. rectum, oral cavity, vagina, lower urinary tract, upper respiratory tract, etc. (Table 11.1).

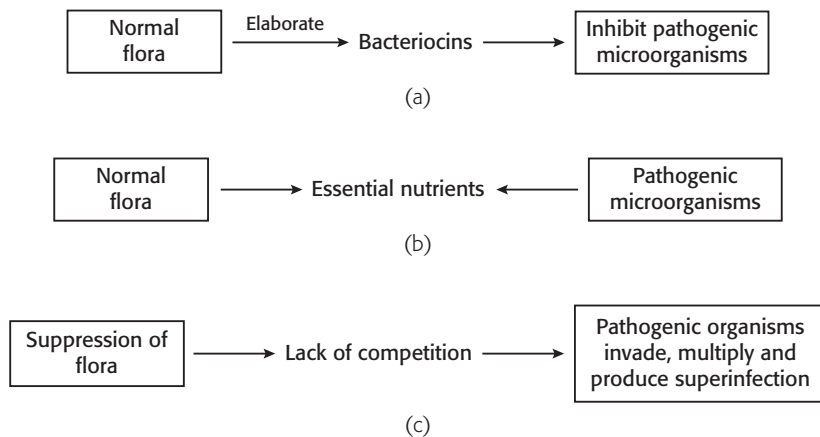

Fig. 11.2 (a-c) Pathogenesis of superinfection. [Fig. 11.2 (b) depicts competition between normal flora and pathogen].

Table 11.1 Microorganisms Causing Superinfection and Its Treatment

Manifestations	Microorganisms	Treatment
Diarrhoea, oral thrush	<i>Candida albicans</i>	Nystatin, clotrimazole, fluconazole
Pseudomembranous enterocolitis	<i>Clostridium difficile</i>	Metronidazole, vancomycin
Urinary tract infection	<i>Escherichia coli</i> , <i>Proteus</i> , <i>Pseudomonas</i>	Ciprofloxacin, gentamicin, carbenicillin

Factors predisposing to superinfection

Superinfection is common in immunocompromised conditions, such as diabetes, malignancy and AIDS; also during prolonged corticosteroid therapy. It can be minimized by (i) using specific antimicrobial agents, (ii) avoiding unnecessary use of AMAs and (iii) use of probiotics, e.g. *Lactobacillus*.

Chemoprophylaxis

Chemoprophylaxis is the administration of antimicrobial agents to prevent infection or to prevent development of disease in persons who are already infected (see Table 11.2). The ideal time to initiate therapy is before the organism enters the body or at least before the development of signs and symptoms of the disease.

Indications for chemoprophylaxis

- To prevent endocarditis in patients with valvular lesion before undergoing any surgical procedures:
Surgical procedures → mucosal damage → bacteraemia → affects damaged valve → endocarditis.

2. *To protect healthy persons:* Chloroquine /mefloquine is used for chemoprophylaxis of malaria for those travelling to malaria-endemic area.
3. *To prevent infection in patients undergoing organ transplantation:* Oral fluoroquinolones can be used.
4. *To prevent opportunistic infections in immunocompromised patients,* e.g. cotrimoxazole is used to prevent *Pneumocystis jiroveci* pneumonia in AIDS patients.
5. *Prior to surgical procedures:* Antimicrobial agents are administered to all patients prior to major dental surgical procedures or implantation of prosthetic devices and in patients who are diabetics or on prolonged corticosteroids to prevent wound infection after surgery.
6. *To prevent infection in patients with burns:* Topical silver sulphadiazine and systemic antibiotics are used.

Suggested chemoprophylactic regimens

The effectiveness of chemoprophylaxis depends on the selection of specific antimicrobial agent, its dosage, time of initiation and duration of antimicrobial therapy. The suggested chemoprophylactic regimens are listed in Table 11.2.

Empirical therapy: It is the use of antimicrobial agents before the identification of causative organism or availability of susceptibility test results, e.g. combination of amoxicillin, cefotaxime and vancomycin is used as empirical therapy for suspected bacterial meningitis (before test results are available) to cover possible organisms likely to cause meningitis.

Definitive therapy: It involves the use of antimicrobial agent after identification/susceptibility tests of causative organism responsible for the disease.

Table 11.2 Chemoprophylactic Regimens

Infection	Antimicrobial Agent with Dose and Duration
1. Chemoprophylaxis for endocarditis before surgical procedures	
• Oral regimens	Amoxicillin 2 g, 1 h before procedure or Cephalexin 2 g, 1 h before procedure
If patient is allergic to penicillin	Clindamycin 600 mg, 1 h before procedure Or Azithromycin 500 mg, 1 h before procedure
• Parenteral regimens	Ampicillin 2g i.m. or i.v. 30 min before procedure Or Cefazolin 1 g i.v. or i.m., 30 min before procedure
If patient is allergic to penicillin	Clindamycin 600 mg i.v. 1 h before procedure
2. Meningococcal and <i>H. influenzae</i> meningitis	Rifampicin 600 mg orally, every 12 hours for four doses. Children 10 mg/kg orally, every 12 h for four doses Rifampicin is the most effective antimicrobial agent in eradicating the organism from the nasopharynx, thus eliminating the carrier state
3. Rheumatic fever	Benzathine penicillin G 12 lakh units i.m. once a month and continued for life-time

■ Combination of Antimicrobial Agents

It is the simultaneous use of two or more antimicrobial agents for the treatment of certain infectious diseases.

Indications/advantages of antimicrobial combinations

1. *To broaden the spectrum of activity in mixed bacterial infections:* Odontogenic infections, brain abscess, etc. are often due to both aerobic and anaerobic organisms. Hence, they require antimicrobial combination therapy.
 - Metronidazole + ampicillin for ulcerative gingivitis.
2. *In severe infections when the aetiology is not known:* Combination of antimicrobial agents is used for empirical therapy. Later, the AMA should be selected according to the type of organism, culture and sensitivity results.
3. *To increase antibacterial activity in the treatment of specific infections (for synergistic effect).*
 - Ampicillin + gentamicin for enterococcal endocarditis.
 - Carbenicillin + gentamicin for infections due to *Pseudomonas*.
Penicillins, by inhibiting bacterial cell wall synthesis, facilitate the entry of gentamicin into the bacterial cell (synergistic effect).
 - Sulphamethoxazole + trimethoprim for *P. jiroveci* pneumonia (see p. 305 for mechanism of action).
4. *To prevent emergence of resistant microorganisms:* In tuberculosis (TB), leprosy and HIV infection, combination therapy is used.
5. *To reduce duration of therapy:* Multidrug therapy is used in TB and leprosy.
6. *To reduce adverse effects:* Amphotericin B (AMB) and flucytosine in cryptococcal meningitis: the dose-dependent toxicity (especially nephrotoxicity) of AMB is reduced due to reduction in the dosage (see p. 342).

Disadvantages of antimicrobial drug combinations

1. *Increased toxicity,* e.g. vancomycin with tobramycin may cause enhanced nephrotoxicity.
2. *Increased cost.*
3. *Decreased antibacterial activity* due to improper combinations, e.g. in pneumococcal meningitis, activity of penicillin G (bactericidal) against pneumococci will decrease if combined with tetracycline (bacteriostatic).
4. *Increased likelihood of superinfection.*
5. *Irrational combination of AMAs can lead to development of resistance.*

■ List of Microorganisms

1. **Gram-positive cocci:** *Staphylococcus aureus*, *Streptococcus pyogenes*, *Streptococcus viridans*, *Streptococcus β-haemolyticus*, *Streptococcus pneumoniae* (pneumococcus), *Enterococcus*.
2. **Gram-negative cocci:** *Neisseria gonorrhoeae*, *Neisseria meningitidis*.
3. **Gram-positive bacilli:** *Bacillus anthracis*, *Corynebacterium diphtheriae*, *Clostridium tetani*, *Clostridium perfringens*, *Clostridium difficile*.
4. **Gram-negative bacilli:** *E. coli*, *Enterobacter* spp., *Proteus*, *Pseudomonas*, *Salmonella*, *Shigella*, *Haemophilus influenzae*, *Haemophilus ducreyi*, *Klebsiella*, *Brucella*, *Vibrio cholerae*.
5. **Acid-fast bacilli:** *Mycobacterium tuberculosis*, *Mycobacterium leprae*, *Mycobacterium avium* complex (MAC).

6. **Spirochetes:** *Treponema pallidum*, *Leptospira*.
7. **Others:** *Rickettsia*, *Mycoplasma pneumoniae*, *Chlamydia trachomatis*, *Helicobacter pylori*, etc.

■ Selection of an Appropriate Antimicrobial Agent (Fig. 11.3)

Patient factors

1. **Age:** Use of chloramphenicol in premature infants may produce gray-baby syndrome because the metabolic functions of the liver and renal excretion are not fully developed. Sulphonamides in neonates can cause kernicterus (see p. 304).
Renal function declines with age; hence, elderly patients are more prone to ototoxicity and nephrotoxicity with aminoglycosides due to its reduced clearance by the kidney.
2. **History of allergy:** In patients with history of asthma, allergic rhinitis, hay fever, etc. there is an increased risk of penicillin allergy; hence such drugs should be avoided.
3. **Genetic abnormalities:** Primaquine, pyrimethamine, sulphonamides, sulfones, fluoroquinolones, etc. may cause haemolysis in patients with glucose-6-phosphate dehydrogenase (G6PD) deficiency.
4. **Pregnancy:** Most of the AMAs cross the placental barrier and may affect the developing foetus. The risk of teratogenicity is highest during the first trimester. For example, use of tetracyclines during pregnancy may affect foetal dentition and bone growth. There is an increased incidence of hepatotoxicity with tetracycline in pregnant women.
5. **Host defences:** In immunocompromised patients (AIDS, leukaemias and other malignancies), normal defence mechanisms are impaired—bacteriostatic drugs may not be adequate; hence bactericidal agents should be used to treat infection.
6. **Hepatic dysfunction:** In patients with hepatic dysfunction, drugs like chloramphenicol, erythromycin, rifampin, etc. should be avoided or require dose reduction to avoid toxic effects.

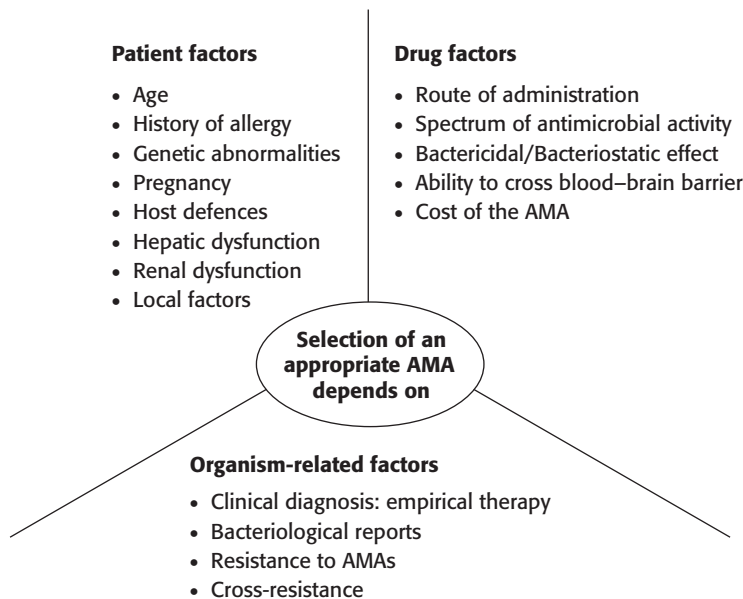

Fig. 11.3 Factors affecting selection of an antimicrobial agent.

7. *Renal dysfunction*: In renal failure, drugs that are eliminated via kidney can accumulate in the body and cause severe toxic effects. Hence aminoglycosides, vancomycin, amphotericin B, fluoroquinolones, etc. should be avoided or require dose reduction in patients with impaired renal function.
8. *Local factors*:
 - a. Antimicrobial activity of sulphonamides is markedly reduced in the presence of pus.
 - b. The activity of aminoglycosides is enhanced at alkaline pH.

Drug factors

1. *Route of administration*: Depending upon the severity and site of infection, the AMAs have to be chosen. Some of the AMAs can be administered orally as well as parenterally. For mild-to-moderate infections, oral route is usually preferred, but for severe infections like endocarditis, meningitis, etc. parenteral antibiotics are preferred during initial stages of therapy.
2. *The spectrum of antimicrobial activity*: It is an important factor while selecting an AMA especially during empirical therapy.
3. *Bactericidal/bacteriostatic effect*: Bactericidal drugs kill the organisms while static drugs inhibit growth and multiplication. In immunocompromised states, the host-defence mechanisms are impaired; hence bactericidal drugs are required even for trivial infections.
4. *Ability to cross blood–brain barrier (BBB)*: Pharmacokinetic profile of the drug is important, e.g. clindamycin is effective against anaerobes, but not useful for anaerobic brain abscess as it does not reach cerebrospinal fluid (CSF) and brain. Anaerobic brain abscess can be treated effectively with third-generation cephalosporins or combination of metronidazole and chloramphenicol.
5. *Cost of the antimicrobial agent*: The cost of treatment has to be considered while selecting an antimicrobial agent. The expensive antimicrobials should not be used routinely when alternative cheaper and effective AMAs are available.

Organism-related factors

In severe infections, empirical therapy with antimicrobial drug combination should be initiated depending on the clinical diagnosis. Later, the AMA should be selected according to the type of organism, culture and sensitivity reports. The bacterial resistance to AMAs and cross-resistance should also be considered while selecting an antimicrobial agent.

Key Points for Dentists

- Chemoprophylaxis is needed in patients with valvular lesions before undergoing dental procedures.
- Superinfection (e.g. oral thrush) is common in immunocompromised patients.
- Irrational use of antimicrobial agents can lead to development of resistance.

SULPHONAMIDES

The sulphonamides were the first effective antimicrobial agents used in the treatment of bacterial infections in man. They are derivatives of sulphanilamide (*para*-aminobenzene sulphonamide) and are synthetic compounds (Fig. 11.4).

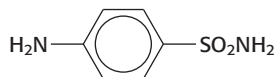
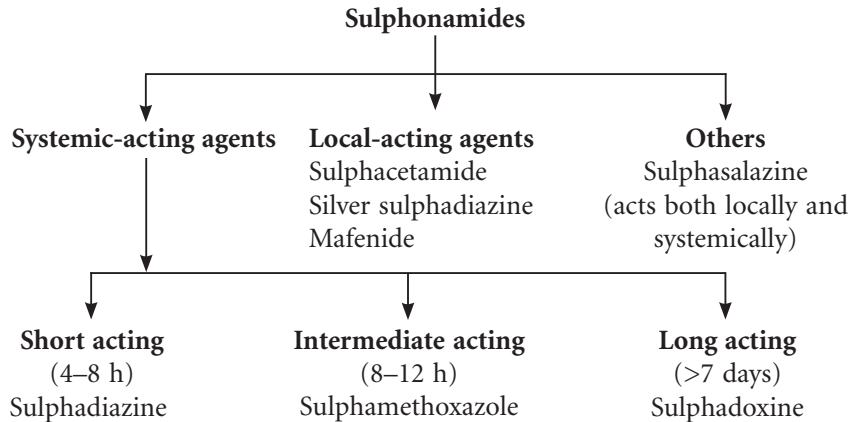
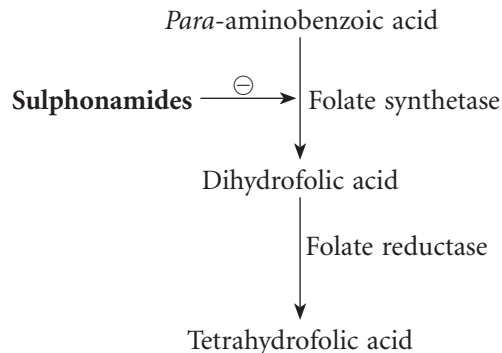

Fig. 11.4 Basic structure of sulphonamides.



Mechanism of action

Para-aminobenzoic acid (PABA) is a precursor of folic acid, which is essential for the growth and multiplication of many bacteria. Sulphonamides, being structurally similar to PABA, competitively inhibit folate synthetase enzyme and prevent the formation of folic acid, thereby producing bacteriostatic effect. Sulphonamides are not effective in the presence of pus as it is rich in PABA, purines and thymidine. Mammalian cells do not synthesize folic acid, but utilize folic acid present in the diet, hence are unaffected by sulphonamides.



Bacterial resistance to sulphonamides

Most of the bacteria have developed resistance to sulphonamides. It could be due to:

1. decreased affinity of folate synthetase for the drug.
2. efflux of the drug by bacteria.
3. development of alternate metabolic pathway for folate synthesis.

Pharmacokinetics

All systemic acting sulphonamides are well absorbed from the gut. They are bound to plasma proteins, particularly albumin. Sulphonamides are distributed in almost all the tissues of the body including CSF. They cross placental barrier and reach foetal circulation; they are metabolized in liver mainly by acetylation. The acetylated products have no antibacterial activity, but retain the toxic potential of the parent compound. Sulphonamides are excreted partly unchanged and partly as metabolic products.

Adverse effects

1. The acetylated products of sulphonamides are poorly soluble in acidic urine and may cause crystalluria, haematuria or even obstruction to urinary tract. This may be avoided by taking plenty of water and alkalinizing the urine.
2. Hypersensitivity reactions include skin rashes, itching, drug fever and exfoliative dermatitis. Stevens–Johnson syndrome is the most severe type of hypersensitivity reaction characterized by fever, erythema multiforme and ulceration of mucous membranes.
3. In patients with G6PD deficiency, sulphonamides may cause acute haemolytic anaemia.
4. Rarely cause hepatitis and suppression of bone marrow.
5. Use of sulphonamides in neonates, especially in premature babies, may cause displacement of bilirubin from plasma proteins. The free bilirubin can cross the blood–brain barrier and get deposited in the basal ganglia resulting in kernicterus.

Drug interactions

Sulphonamides potentiate the effect of phenytoin, methotrexate, oral anticoagulants and oral hypoglycaemic agents (sulfonylureas) by inhibiting their metabolism and displacing them from plasma protein binding sites.

Therapeutic uses

Sulphonamides alone are rarely used now for systemic infections. They are used in combination with other antimicrobial agents.

1. Sulphadoxine and pyrimethamine can be used in combination with artesunate in the treatment of mefloquine-resistant *Plasmodium falciparum* malaria.
2. Sodium salt of sulphacetamide is used topically for the treatment of ophthalmic infections.
3. Silver sulphadiazine and mafenide are used topically for preventing infection of burn wound. Silver sulphadiazine is not effective in the presence of pus and tissue fluid.

COTRIMOXAZOLE

Cotrimoxazole is a World Health Organization (WHO)-approved–fixed-dose combination of sulphamethoxazole and trimethoprim in the ratio of 5:1.

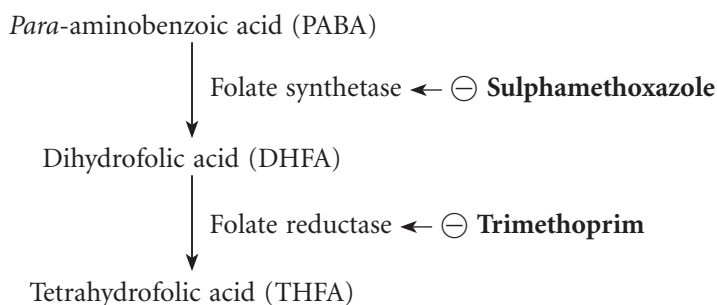
Mechanism of action

Cotrimoxazole (sulphamethoxazole and trimethoprim) produces **sequential blockade**, i.e. two drugs interfere with two successive steps in the same metabolic pathway; hence, their combination produces supra-additive effect. Sulphamethoxazole inhibits folate synthetase whereas trimethoprim inhibits folate reductase enzyme. The pharmacokinetic properties of these two drugs match each other almost closely;

hence they are selected for combination. Optimum synergistic effect is seen at a concentration ratio of 20:1 (sulphamethoxazole to trimethoprim) in blood and tissues. The advantages of this combination are:

1. Individually, both are bacteriostatic but the combination has a cidal effect.
2. Chances of development of bacterial resistance are also greatly reduced.

Pharmacokinetics

Cotrimoxazole is well absorbed after oral administration and is also available for parenteral use; widely distributed to various tissues including the CSF and sputum; metabolized in liver and excreted mainly in urine; hence dose reduction is needed in patients with renal insufficiency.

Adverse effects

Cotrimoxazole is well tolerated in most patients. Most of the adverse effects are same as that of sulphonamides. The common adverse effects are skin rashes and gastrointestinal (GI) disturbances. Exfoliative dermatitis, erythema multiforme and Stevens–Johnson syndrome are rare. The GI symptoms include nausea, vomiting, glossitis and stomatitis. Megaloblastic anaemia due to folate deficiency may occur rarely, especially in alcoholics and malnourished persons. Bone marrow suppression with leukopaenia, neutropaenia and thrombocytopenia occurs rarely. Cotrimoxazole is contraindicated in pregnancy.

The **preparations** of cotrimoxazole are shown in Table 11.3.

Table 11.3 Preparations of Cotrimoxazole

Strength of Cotrimoxazole	Preparations
Sulphamethoxazole 400 mg + Trimethoprim 80 mg	Oral, i.v.
Sulphamethoxazole 800 mg + Trimethoprim 160 mg	Double strength (DS); Oral, i.m.
Sulphamethoxazole 200 mg + Trimethoprim 40 mg	Oral suspension
Sulphamethoxazole 100 mg + Trimethoprim 20 mg	Paediatric tab.

Therapeutic uses

1. **Urinary tract infection:** Cotrimoxazole is effective for the treatment of acute, chronic and recurrent lower urinary tract infections (UTIs) due to gram-negative organisms such as *E. coli*, *Proteus* and *Enterobacter* spp. The usual dose is 800 mg sulphamethoxazole plus 160 mg of trimethoprim (cotrimoxazole double-strength tablet) daily for 3 days.
2. **Bacterial respiratory tract infections:** Cotrimoxazole is effective for acute and chronic bronchitis due to *S. pneumoniae* and *H. influenzae*. It is also useful for acute maxillary sinusitis and otitis media.
3. **Bacterial diarrhoeas:** Cotrimoxazole may be used for GI infections due to shigella, *E. coli* and *Salmonella* spp. But fluoroquinolones are the preferred agents.
4. **Typhoid fever** (see pp 308 and 316): Fluoroquinolones (ciprofloxacin, ofloxacin, levofloxacin, etc.) or third-generation cephalosporins (ceftriaxone and cefoperazone) are the treatment of choice for typhoid fever. Cotrimoxazole may also be effective.
5. ***P. jiroveci* infections:** Cotrimoxazole is useful for the treatment as well as prophylaxis of *P. jiroveci* pneumonia.
7. **Chancroid:** Cotrimoxazole is effective.

Key Points for Dentists

- Plenty of water should be given with sulphonamides to avoid crystalluria.
- Sulphonamides are not effective in the presence of pus.

QUINOLONES

The first quinolone, nalidixic acid, is a urinary antiseptic. It is useful in the treatment of uncomplicated UTI due to gram-negative bacteria and diarrhoea due to *Shigella* or *Salmonella*. The most common adverse effects are related to GI tract, central nervous system (CNS) and skin.

Fluoroquinolones are synthetic fluorinated analogues of nalidixic acid. The important fluoroquinolones are norfloxacin, ciprofloxacin, pefloxacin, ofloxacin, levofloxacin, gemifloxacin and moxifloxacin. (Table 11.4).

Mechanism of action

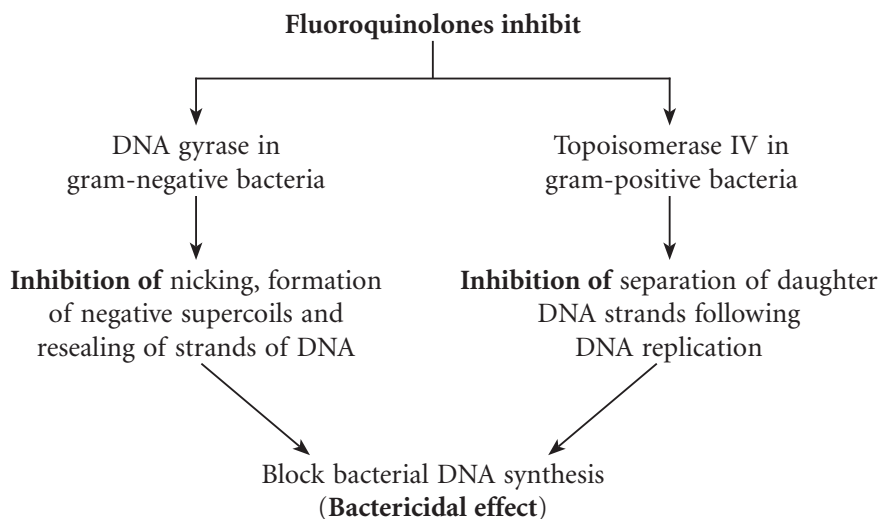

Fluoroquinolones inhibit bacterial DNA gyrase resulting in the inhibition of DNA synthesis, which is responsible for their activity against gram-negative bacteria. They also inhibit topoisomerase IV, which contributes to their activity against gram-positive bacteria.

Antibacterial spectrum

Ciprofloxacin is the prototype drug. Ciprofloxacin is highly effective against aerobic gram-negative organisms—*E. coli*, *Enterobacter*, *Proteus*, *Klebsiella*, *Salmonella*, *Shigella*, *H. ducreyi*, *H. influenzae*, *N. gonorrhoeae*, *N. meningitidis*, *Vibrio cholerae* and *Campylobacter jejuni*.

It has activity against—*S. aureus*, *Pseudomonas aeruginosa* and *Mycobacterium tuberculosis*.

Most of the anaerobes—*Bacteroides fragilis*, *C. difficile*, etc. are resistant to ciprofloxacin.

Newer fluoroquinolones like levofloxacin, gemifloxacin, moxifloxacin, etc. have greater activity against streptococci and some activity against anaerobes.

Pharmacokinetics

Ciprofloxacin is administered by oral, i.v. or topical routes. It is well absorbed from the gut; but food delays its absorption. It is widely distributed in the body, reaches high concentration in kidney, lungs, prostatic tissue, bile, macrophages, etc. It is excreted mainly in urine.

Adverse effects

- The common adverse effects are related to GI tract, e.g. nausea, vomiting and abdominal discomfort.
- CNS effects include headache, dizziness, insomnia, confusion, hallucinations and convulsions.
- Hypersensitivity reactions include skin rashes, urticaria, itching, eosinophilia and photosensitivity.

Table 11.4 Pharmacokinetics, Antibacterial Spectrum, Uses and Drug Interactions of Fluoroquinolones

Fluoroquinolone	Routes of Administration	Oral Bioavailability	Antibacterial Spectrum and Uses	Drug Interactions
Norfloxacin	Oral, topical (eye)	30–40%	Mainly against gram-negative organisms, but not <i>Pseudomonas</i> Uses: It is used mainly in the treatment of urinary tract infections and bacterial diarrhoeas	Inhibits metabolism of theophylline and warfarin
Ciprofloxacin	Oral, i.v. infusion, topical (eye)	70%	(See pp. 306 and 308)	Inhibits metabolism of theophylline and warfarin
Pefloxacin	Oral, i.v. infusion	Almost 100%	Similar to ciprofloxacin, also effective against <i>Mycobacterium leprae</i> Uses: Typhoid, gonococcal infection, UTI, bacterial diarrhoeas and leprosy	Inhibits metabolism of theophylline and warfarin
Ofloxacin	Oral, i.v. infusion, topical (eye)	Almost 100%	Effective against gram-negative organisms, gram-positive organisms and some anaerobes; has activity against <i>Chlamydia</i> , <i>Mycoplasma</i> and mycobacteria Uses: Tuberculosis (TB), leprosy	Inhibits the metabolism of theophylline, but to a lesser extent
Moxifloxacin	Oral, i.v. infusion, topical (eye)	90%	More active against gram-positive bacteria including <i>S. pneumoniae</i> , <i>M. tuberculosis</i> and some anaerobes (<i>Bacteroides fragilis</i>) Uses: Community-acquired pneumonia, chronic bronchitis and sinusitis. It is useful in odontogenic infection as it has activity against gram-positive and some of the anaerobes.	—
Levofloxacin	Oral, i.v., topical (eye drops)	100%	Increased activity against <i>S. pneumoniae</i> ; effective against gram-negative bacteria and anaerobes. Uses: Community-acquired pneumonia, sinusitis, chronic bronchitis, etc.	—

- Tenosynovitis and tendon rupture can occur, especially in athletes.
- Moxifloxacin can cause prolongation of QT interval.
- Fluoroquinolones are contraindicated in pregnancy.
- Fluoroquinolones have caused cartilage damage in animals, hence should be avoided in young children.

Drug interactions

Ciprofloxacin increases the plasma concentration of theophylline, warfarin, etc. by inhibiting their metabolism.

Nonsteroidal antiinflammatory drugs (NSAIDs) may potentiate the CNS side effects of fluoroquinolones—confusion, irritability and rarely convulsions may occur.

Like tetracyclines, the absorption of fluoroquinolones is reduced by antacids, ferrous salts and sucralfate.

Other fluoroquinolones have been discussed in Table 11.4.

Uses of fluoroquinolones

1. *Urinary tract infections:* Fluoroquinolones are one of the most commonly used antimicrobial agents for UTI. Fluoroquinolones are superior to cotrimoxazole for the treatment of UTI.
2. *Bacterial diarrhoeas:* Fluoroquinolones are effective for a variety of GI infections caused by *E. coli*, *Shigella*, *Salmonella*, etc.
3. *Typhoid fever:* Ciprofloxacin (750 mg orally b.d. for 10 days) is the preferred drug for the treatment of typhoid. Multidrug-resistant cases are treated with ceftriaxone.
4. *Sexually transmitted diseases:* Fluoroquinolones are effective for chancroid and gonococcal infections.
5. *Respiratory infections:* Newer fluoroquinolones (levofloxacin and moxifloxacin) are highly effective for community-acquired pneumonias and chronic bronchitis.
6. *Others:* Skin, soft tissue, and bone infection; fluoroquinolones are used in combination with other antimicrobial agents in multidrug-resistant (MDR) tuberculosis and leprosy.

Key Points for Dentists

- Fluoroquinolones are contraindicated in pregnancy.
- Avoid fluoroquinolones in athletes as there is an increased incidence of tenosynovitis and tendon rupture.

β-LACTAM ANTIBIOTICS

Beta-lactam antibiotics include penicillins, cephalosporins, carbapenems and monobactams. All of them have a β-lactam ring in their chemical structure (Fig. 11.5), hence the name β-lactam antibiotics.

PENICILLINS

Penicillin was the first antibiotic developed and used clinically. It was discovered accidentally by Alexander Fleming. The source of penicillin is the high-yielding *Penicillium chrysogenum*.

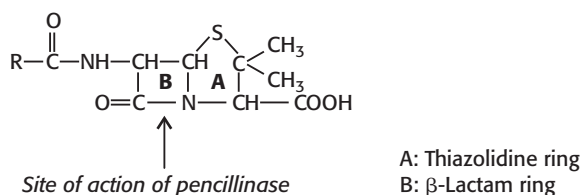

Fig. 11.5 The structure of penicillins.

Mechanism of action (Fig. 11.6)

Beta-lactam antibiotics produce bactericidal effect by inhibiting cell wall synthesis in susceptible bacteria. Bacterial cell wall is composed of peptidoglycan, which has glycan chain cross-linked by peptide chain. The glycan chain is composed of alternating amino sugars, NAM (*N*-acetylmuramic acid) and NAG (*N*-acetylglucosamine). A pentapeptide (five amino acids), linked to NAM, has a pentaglycine attached to it. This pentaglycine is cross-linked with a pentapeptide of adjacent strand. Transpeptidase (penicillin binding protein) causes cross-linking between the pentaglycine residue of one strand and fourth

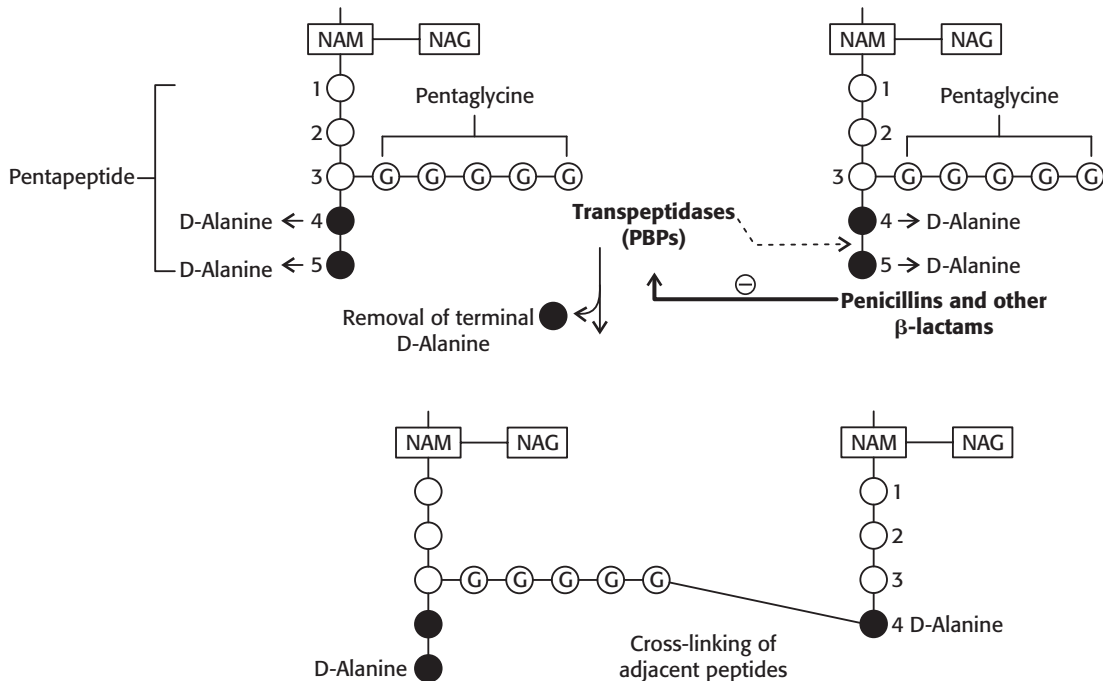

Fig. 11.6 Cross-linking of peptidoglycan residues and site of action of β -lactam antibiotics.

aminoacid (D-alanine) of adjacent pentapeptide by cleavage of the terminal D-alanine (fifth aminoacid residue). This cross-linking makes the cell wall rigid and also gives it stability.

β -Lactams, structural analogues of D-alanine, inhibit transpeptidase and thus peptidoglycan synthesis. Cell wall-deficient forms are produced, which undergo lysis (bactericidal action). Beta-lactams exert their cidal effect when the bacteria actively multiply and synthesize cell wall.

Penicillin-binding proteins (PBPs), consisting of transpeptidase, other enzymes and related proteins are located in the cell membrane of bacteria. The cell wall in *gram-positive bacteria* is composed mainly of highly cross-linked peptidoglycan, which is 50–100-layers thick and is near the cell surface. In *gram-negative bacteria*, the peptidoglycan layer is only 1–2 molecules thick. In addition, there is an outer lipopolysaccharide layer. Hence, gram-negative organisms are less susceptible to penicillins than gram-positive organisms.

Mechanism of bacterial resistance to penicillins

Bacteria develop resistance (i) by producing β -lactamases, which destroy the β -lactam ring, e.g. *S. aureus*, *E. coli*, gonococci, *H. influenzae*, etc. (ii) due to altered PBPs, which have less affinity for β -lactams, e.g. *S. pneumoniae* (iii) due to decreased ability of the drug to penetrate to its site of action.

Pharmacokinetics

Most of the orally administered penicillin G is destroyed by gastric acid (acid labile); hence penicillin G is usually given by i.v. route. It can also be administered by i.m. route but is painful. Penicillin G is widely distributed in body tissues, but poorly crosses the BBB; although during meningitis, adequate amount reaches the CSF. Penicillin G is rapidly excreted in urine mainly by active tubular secretion. Since renal function is not completely developed in infants and neonates, hence excretion of penicillins is slow. The action of penicillins can be augmented and prolonged by giving probenecid simultaneously.

Preparations of penicillin G

The duration of action of penicillin G is increased by combining it with poorly water-soluble compounds, such as procaine (procaine penicillin G) or benzathine (benzathine penicillin G) to yield aqueous suspensions. They are called repository or depot penicillins (Table 11.5, Fig. 11.7).

Table 11.5 Characteristic Features of Preparations of Penicillin G

Penicillin	Route and Dose	Duration of Action	Special Features
1. Penicillin G (benzyl penicillin, crystalline penicillin)	i.v., i.m. 20–24 million units (MU) daily	4–6 h	Rapid onset of action, reaches high plasma concentration; mainly used in severe infections—meningitis, endocarditis, pneumonia, etc.
2. Repository penicillins (depot penicillins)			
• Procaine penicillin G	i.m. 6–12 lakh units (0.6–1.2 MU) daily	12–24 h	Moderate plasma concentration, used in mild-to-moderate infections; less painful because of procaine component
• Benzathine penicillin G	i.m. 6–24 lakh units (0.6–2.4 MU), once a month	3–4 weeks	Slow onset but has longest duration of action among penicillins. Used in syphilis, rheumatic fever prophylaxis, etc.
• Fortified procaine penicillin G	3 lakh U procaine penicillin G + 1 lakh U penicillin G i.m.	12–24 h	Rapid onset with high plasma concentration and longer duration of action; used in mild-to-moderate infections by sensitive organisms

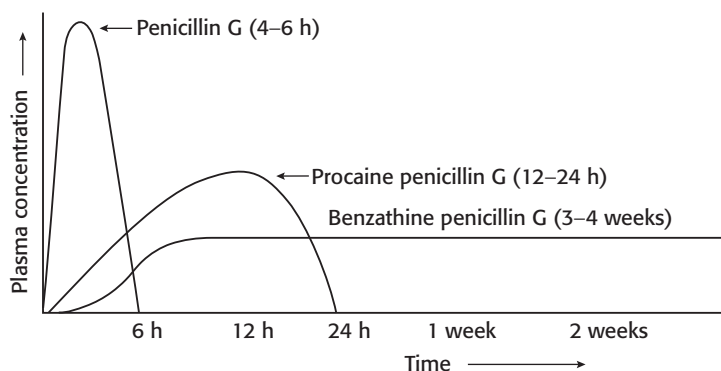

Fig. 11.7 Preparations of penicillin G with their duration of action and plasma concentration.

Adverse reactions of penicillin G

Penicillins are relatively safe. They may cause hypersensitivity reactions, such as skin rashes, urticaria, fever, dermatitis, bronchospasm, angioedema, joint pain, serum sickness or anaphylactic reaction.

The major manifestations of anaphylactic shock are severe hypotension, bronchospasm and laryngeal oedema. It is an immunoglobulin E (IgE) mediated, immediate type of hypersensitivity reaction (Type-I hypersensitivity). It is not a dose-related adverse drug reaction and can occur with any dosage form of penicillin. Cross-reactivity can occur among penicillins and also among β -lactams antibiotics.

Treatment of anaphylactic shock

1. Inj. adrenaline 0.3–0.5 mL of 1:1000 solution intramuscularly.
2. Inj. hydrocortisone 200 mg intravenously.
3. Inj. diphenhydramine 50–100 mg intramuscularly or intravenously.

Precautions

1. Before giving penicillin, history of previous administration and allergic manifestations, if any, must be noted.
2. In patients with history of asthma, allergic rhinitis, hay fever, etc. there is an increased risk of penicillin allergy; hence it should be avoided in such cases.
3. Sensitivity test should be performed by an intradermal test on the ventral aspect of forearm. Itching, erythema and wheal formation are watched for. A negative skin test does not ensure absolute safety.
4. Inj. adrenaline and hydrocortisone should be kept ready before injecting penicillin to treat the anaphylactic reaction.

Other adverse effects of penicillins are pain and sterile abscess at the site of i.m. injection. Prolonged use of i.v. penicillin G may cause thrombophlebitis.

Jarisch–Herxheimer reaction: It is an acute exacerbation of signs and symptoms of syphilis during penicillin therapy due to release of endotoxins from the dead organisms. The manifestations are fever, chills, myalgia, hypotension, circulatory collapse, etc. It is treated with aspirin and corticosteroids.

Therapeutic uses of penicillin G

Owing to the risk of anaphylaxis as well as availability of better antimicrobial agents, the use of penicillin G has declined.

1. *In dentistry:* Penicillins are used in Vincent's angina, necrotizing gingivitis, periodontal infections, etc. either alone or with metronidazole.
2. *Pneumococcal infections:* In pneumonia, meningitis or other serious infections, third-generation cephalosporins are the drug of choice. However, i.v. penicillin G can be used as an alternative if the organism is sensitive.
3. *Streptococcal infections:* Penicillin G is useful for the treatment of streptococcal pharyngitis, otitis media, rheumatic fever, etc. Procaine penicillin G or benzathine penicillin G is used for the treatment of rheumatic fever.
4. *Meningococcal meningitis:* Third-generation cephalosporins (cefotaxime or ceftriaxone) are preferred. Intravenous penicillin G is also effective. It does not eliminate carrier state. Rifampin attains high concentration in nasopharynx and eliminates the meningococcal carrier state. Hence, rifampin but not penicillin G is used for prophylaxis of meningitis.
5. *Gonococcal infections:* Penicillin was the drug of choice for gonococcal infections. Because of the emergence of resistant organisms, penicillins are not preferred at present. Third-generation cephalosporins, ceftriaxone or cefixime are the drug of choice for uncomplicated gonococcal infections.
6. *Syphilis:* Penicillin G is the drug of choice for syphilis. The alternative drugs are ceftriaxone and azithromycin and doxycycline.
7. *Diphtheria:* It is an acute infection of upper respiratory tract caused by *C. diphtheriae*. It is treated mainly with the specific antitoxin. Penicillin G helps to eliminate the carrier state. Patients allergic to penicillin are treated with erythromycin.

8. *Clostridial infections (tetanus and gas gangrene)*: The main treatment is the neutralisation of the toxin by using human tetanus immunoglobulin. For gas gangrene, penicillin G is used as an adjunct to antitoxin.
9. *Other infections*: Anthrax, listeria infections, lyme disease, leptospirosis, actinomycosis, rat-bite fever, etc. are effectively treated with penicillin G.
10. *Anaerobic infections*: Penicillin G is effective for the treatment of anaerobic infections (periodontal).

Prophylactic uses of penicillins

1. *Rheumatic fever*: The causative organism is group-A β -haemolytic streptococcus. For rheumatic fever prophylaxis, inj. benzathine penicillin G is the ideal agent. It is given i.m. once a month and continued for life in high-risk people. Patients allergic to penicillin are treated with erythromycin or sulphadiazine.
2. *Bacterial endocarditis*: Patients with valvular lesions are at high risk of developing infective endocarditis; hence they should receive chemoprophylactic agents before dental or surgical procedures to prevent bacteraemia (see p. 298).

Limitations/drawbacks of penicillin G

1. Acid labile – orally not very effective.
2. Short duration of action (to overcome this, repository penicillins have been developed).
3. Narrow spectrum of antibacterial activity (mainly against gram-positive organisms).
4. Destroyed by penicillinase enzyme.
5. Possibility of anaphylaxis.

To overcome most of the above drawbacks, semisynthetic penicillins have been developed (Table 11.6).

Therapeutic uses of aminopenicillins

1. *In dentistry*: Amoxicillin is used alone or with metronidazole in acute necrotizing ulcerative gingivitis, dentoalveolar abscess, osteomyelitis of mandible, etc. Ampicillin–sulbactam is useful for the treatment of Ludwig’s angina in immunocompetent individuals.
2. *Upper respiratory infections*: Ampicillin and amoxicillin (Table 11.7, p. 314) are effective for pharyngitis, sinusitis, otitis media, bronchitis, etc. caused by *S. pyogenes*, *S. pneumoniae* and *H. influenzae*. Among oral β -lactams, amoxicillin is the most effective agent against penicillin-sensitive and penicillin-resistant *S. pneumoniae* (Table 11.6).
3. *Subacute bacterial endocarditis*: Aminopenicillins in combination with gentamicin have been used for the treatment of subacute bacterial endocarditis (SABE). To prevent bacterial endocarditis in patients with valvular lesions before undergoing dental procedures, amoxicillin is the ideal agent—2g given orally, 1 h before the procedure (see p. 299).
4. *Urinary tract infections*: Fluoroquinolones are the preferred antimicrobial agents for urinary tract infections. Ampicillin can be used if organism is sensitive.
5. *Meningitis*: A combination of ampicillin, vancomycin and third-generation cephalosporins is used for the empirical therapy of bacterial meningitis.
6. *Bacillary dysentery*: Fluoroquinolones are the drugs of choice. Some cases may respond to ampicillin, but many strains have developed resistance to it.
7. *Typhoid fever*: A fluoroquinolone or ceftriaxone is the drug of choice for typhoid. Ampicillin, cotrimoxazole or ciprofloxacin are useful for eradicating carrier state.

Adverse effects of aminopenicillins and drug interactions

The adverse effects of ampicillin are similar to those of penicillin G, but skin rashes and diarrhoea are more common.

Table 11.6 Classification of Penicillins with their Spectrum of Activity

Penicillins	Route of Administration	Penicillinase Susceptible/Resistant	Antimicrobial Spectrum/Uses
1. Natural penicillins			
Penicillin G	i.v., i.m.	Susceptible	<i>Streptococcus</i> species, <i>N. gonorrhoeae</i> , <i>N. meningitidis</i> ,
Procaine penicillin G	i.m.		<i>B. anthracis</i> , <i>Corynebacterium diphtheriae</i> , <i>Clostridium</i> spp., spirochetes (<i>Treponema</i> , <i>Leptospira</i>), <i>Actinomyces</i> and most of the anaerobes (not <i>Bacteroides fragilis</i>)
Benzathine penicillin G	i.m.		
2. Semisynthetic penicillins			
a. Acid-resistant penicillin:			
Phenoxyethyl penicillin (Penicillin V)	Oral	Susceptible	Similar to penicillin G, attains very low plasma concentration, hence used only for mild streptococcal and pneumococcal infections, trench mouth
b. Penicillinase-resistant penicillins			
		Resistant	Sensitive strains of <i>Staphylococcus aureus</i> and <i>S. epidermidis</i> infections (abscesses, cellulitis, pneumonia, etc.)
Methicillin	i.m., i.v.		
Oxacillin	Oral, i.m., i.v.		
Cloxacillin			
Dicloxacillin			
c. Extended-spectrum penicillins			
• Aminopenicillins			
Ampicillin	Oral, i.m., i.v.	Susceptible	Antimicrobial spectrum extended to gram-negative bacilli; <i>Escherichia coli</i> , <i>Proteus</i> , <i>Salmonella</i> , <i>Shigella</i> , <i>Haemophilus influenzae</i> and <i>Helicobacter pylori</i> . Of all the oral β -lactams, amoxicillin is the most active agent against both penicillin-sensitive and penicillin-resistant <i>Streptococcus pneumoniae</i> . Ampicillin is highly effective against <i>Listeria monocytogenes</i> .
Amoxicillin			
• Carboxypenicillins			
Carbenicillin	i.m., i.v.	Susceptible	Infections caused by <i>Pseudomonas aeruginosa</i> and <i>Proteus</i> spp.
Carbenicillin indanyl	Oral		
Ticarcillin	i.v.		
• Ureidopenicillins			
Mezlocillin	i.m., i.v.	Susceptible	<i>Pseudomonas aeruginosa</i> , <i>Klebsiella</i> and <i>Enterobacteriaceae</i> infections (pneumonias, burns and UTIs)
Piperacillin	i.m., i.v.		

Probenecid competes with β -lactams (penicillins and cephalosporins) for active tubular secretion and retards their excretion, thereby increasing the plasma concentration as well as the duration of action of β -lactams. The simultaneous administration of probenecid and penicillin increases the therapeutic efficacy of β -lactams—useful in the treatment of bacterial endocarditis and gonococcal infections.

Table 11.7 Comparison Between Ampicillin and Amoxicillin

Ampicillin	Amoxicillin
Semisynthetic aminopenicillin	Semisynthetic aminopenicillin
Acid stable; incompletely absorbed from GI tract—alters intestinal flora; hence diarrhoea is more common (superinfection)	Acid stable, completely absorbed from GI tract; hence the incidence of diarrhoea is less
Food decreases the absorption of ampicillin	Food does not decrease the absorption of amoxicillin
Effective against <i>Shigella</i> and <i>Haemophilus influenzae</i>	Less effective against <i>Shigella</i> and <i>H. influenzae</i>
Ampicillin reduces the effectiveness of oral contraceptives	Does not reduce the effectiveness of oral contraceptives
Dose: Ampicillin 250–500 mg QID	Dose: Amoxicillin 250–500 mg TID

Antipseudomonal penicillins

They are carbenicillin, carbenicillin indanyl, ticarcillin, mezlocillin and piperacillin.

Uses: Serious infections—bacteremias, pneumonias, UTIs, burns, etc. by *P. aeruginosa* and *Proteus* are more effectively treated with piperacillin than carbenicillin. Carbenicillin indanyl is used orally for the treatment of UTI caused by *P. aeruginosa* and *Proteus* spp.

Ticarcillin with β -lactamase inhibitor is used along with an aminoglycoside for the treatment of mixed nosocomial infection.

Adverse effects are similar to penicillin G. Congestive cardiac failure may be precipitated due to sodium content of carbenicillin sodium. It can also interfere with platelet function and cause bleeding.

■ β -Lactamase Inhibitors

They are clavulanic acid, sulbactam and tazobactam. They structurally resemble β -lactam molecules. Beta-lactamase inhibitors bind to β -lactamases and inactivate them. Coadministration of these drugs with β -lactams increases the activity of β -lactams by preventing them from enzymatic destruction. They are clavulanic acid, sulbactam and tazobactam.

Clavulanic acid:

It competitively and irreversibly inhibits β -lactamases produced by a wide range of gram-positive and gram-negative bacteria. After binding to the enzyme, clavulanic acid itself gets inactivated; hence it is called a 'suicide' inhibitor. Details are given in Table 11.8.

Table 11.8 β -Lactamase Inhibitors and Their Uses

Preparation (Brand Name)	Route(s) of Administration	Uses
1. Clavulanic acid + amoxicillin (Augmentin)	Oral, i.m., i.v.	Skin, soft tissue, otitis media, respiratory and urinary tract infections caused by β -lactamase-producing strains of <i>S. aureus</i> , <i>E. coli</i> , <i>H. influenzae</i> and gonococci
2. Clavulanic acid + ticarcillin (Timentin)	i.m., i.v.	Mixed nosocomial infections due to aerobic gram-negative bacilli, <i>S. aureus</i> and <i>Bacteroides</i> spp.
3. Sulbactam + ampicillin (Sulbacin)	Oral, i.m., i.v.	Intra-abdominal and pelvic infections (mixed aerobic and anaerobic infections) due to β -lactamase-producing strains of <i>S. aureus</i> , gram negative aerobes and anaerobes
4. Tazobactam + piperacillin (Tazobac)	i.v.	Severe infections caused by β -lactamase-producing strains of gram-negative bacilli

CEPHALOSPORINS

The first cephalosporins were obtained from a fungus, *Cephalosporium acremonium*. Later, semisynthetic cephalosporins were developed. Cephalosporins are β -lactam antibiotics. The mechanism of action and resistance are similar to penicillins (see p. 309). Like penicillins, the cephalosporins also inhibit the synthesis of bacterial cell wall and produce bactericidal effect. Cephalosporins have been divided into four generations based on their general features and antibacterial activity.

Pharmacokinetics

Cephalosporins are administered either orally or parenterally (Table 11.9). These drugs are excreted mainly unchanged through kidney either by glomerular filtration or by tubular secretion. Some cephalosporins are metabolized in the body before their excretion. Cefotaxime is deacetylated in the body before its excretion. Cefoperazone is mainly excreted through bile. Like penicillins, the active tubular secretion of cephalosporins is blocked by probenecid, resulting in higher blood levels and longer duration of action.

Table 11.9 Antibacterial Spectrum, Pharmacokinetics and Uses of Cephalosporins

Cephalosporins	First Generation	Second Generation	Third Generation	Fourth Generation
1. Drugs	Cephalexin (O) Cefadroxil (O) Cefazolin (i.m., i.v.) Cephadrine (O, i.m., i.v.) Cephalothin (i.m.)	Cefaclor (O) Cefuroxime axetil (O) Cefuroxime (i.m., i.v.) Cefoxitin (i.m., i.v.) Cefotetan (i.m.) Cefprozil (O)	Cefixime (O) Cefpodoxime proxetil (O) Ceftriaxone (i.m., i.v.) Cefotaxime (i.m., i.v.) Cefoperazone (i.m., i.v.) Ceftazidime (i.m., i.v.) Ceftizoxime (i.m., i.v.) Cefdinir (O) Ceftibuten (O)	Cefepime (i.v.) Cefpirome (i.m., i.v.)
2. Antibacterial spectrum:				
• Against gram-positive organism (except enterococci and MRSA)	+++	++	+	+
• Against gram-negative organisms	+ (<i>E. coli</i> , <i>K. pneumoniae</i>)	++ (<i>E. coli</i> , <i>K. pneumoniae</i> , <i>Proteus</i> , <i>H. influenzae</i>)	+++	+++
• Anaerobes	Effective against oral cavity anaerobes except <i>Bacteroides fragilis</i>	Effective against anaerobes including <i>B. fragilis</i> (cefotetan, cefoxitin)	Effective against anaerobes including <i>B. fragilis</i> (cefoperazone, ceftizoxime)	Not effective against <i>B. fragilis</i> .
• Against <i>Pseudomonas</i>	Not effective	Not effective	Effective (cefoperazone, ceftazidime)	Effective
• Against <i>Salmonella</i>	Not effective	Not effective	Effective (ceftriaxone, cefoperazone)	

(Contd...)

Table 11.9 Contd...

Cephalosporins	First Generation	Second Generation	Third Generation	Fourth Generation
3. β -lactamase enzyme	Among the first-generation agents, cefazolin is highly susceptible to staphylococcal β -lactamases	Cefoxitin and cefuroxime are resistant to β -lactamases produced by gram-negative organism	Most of them are resistant to most of the β -lactamases (except cefoperazone) produced by gram-negative organisms	Same as third generation
4. Blood–brain barrier (BBB)	–	Some of the second-generation drugs (cefuroxime) cross the BBB	Cefotaxime, ceftriaxone cross BBB and reach high concentration in CSF	Cross BBB
5. Uses	<ol style="list-style-type: none"> In dentistry: Cephalexin and cefadroxil can be used orally for odontogenic infections (but not as first-line drugs). Cephalexin/cefadroxil/cefazolin can be used for prophylaxis of bacterial endocarditis before dental procedures as alternatives to amoxicillin. Skin and soft-tissue infections due to streptococci and <i>Staphylococcus aureus</i> Surgical prophylaxis: Cefazolin is preferred because of its longer duration of action 	<ol style="list-style-type: none"> In dentistry: Cefaclor or cefuroxime axetil are useful for orodental infections. Respiratory tract infections: otitis media and sinusitis, oral cefuroxime axetil can be used Cefoxitin and cefotetan are preferred for mixed (gram-negative bacteria and anaerobes) intra-abdominal and pelvic infections 	<p>Third-generation cephalosporins alone or with aminoglycosides are used in severe gram-negative infections</p> <ol style="list-style-type: none"> Pyelonephritis caused by gram-negative organisms: ceftriaxone Community-acquired pneumonia : Ceftriaxone, cefotaxime Gonorrhoea: Ceftriaxone is the drug of choice. Typhoid fever: Ceftriaxone and cefoperazone are very effective for the treatment of multidrug-resistant <i>Salmonella</i> infections Meningitis caused by <i>Haemophilus influenzae</i>: Inj. cefotaxime and ceftriaxone are the preferred drugs Mixed aerobic and anaerobic infections seen in patients with malignancy Septicaemia caused by gram-negative infections Nosocomial infection: Third-generation drugs are useful 	Same as third-generation. They are reserve drugs for hospital-acquired resistant infections

+: less active; ++: moderately active; +++: highly active

Adverse effects

1. Hypersensitivity: The most common adverse effects are allergic reactions. They are skin rashes, urticaria and rarely anaphylaxis. Cross-reactivity to penicillin is seen in few patients.
2. Gastrointestinal disturbances—mainly diarrhoea, vomiting and anorexia can also occur.
3. Pain at the site of i.m. injection mainly with cephalothin. Intravenous cephalosporins can cause thrombophlebitis.
4. Nephrotoxicity may occur. Co-administration of cephalothin and gentamicin increases the nephrotoxicity.
5. Intolerance to alcohol (a disulfiram-like reaction) has been reported with cefotetan and cefoperazone.
6. Severe bleeding can occur either due to hypoprothrombinaemia (which responds to vitamin K therapy) or thrombocytopenia and/or platelet dysfunction.

CARBAPENEMS

Imipenem, an example of a carbapenem, is a semisynthetic β -lactam antibiotic. Imipenem, like other β -lactam antibiotics, acts by inhibiting bacterial cell wall synthesis and produces bactericidal activity. It has a wide spectrum of antibacterial activity—gram-positive organisms like streptococci, staphylococci, enterococci, *Listeria* and *C. difficile* (anaerobe); gram-negative organisms like *P. aeruginosa*, enterobacteriaceae and *B. fragilis* (anaerobes). It is resistant to most β -lactamases.

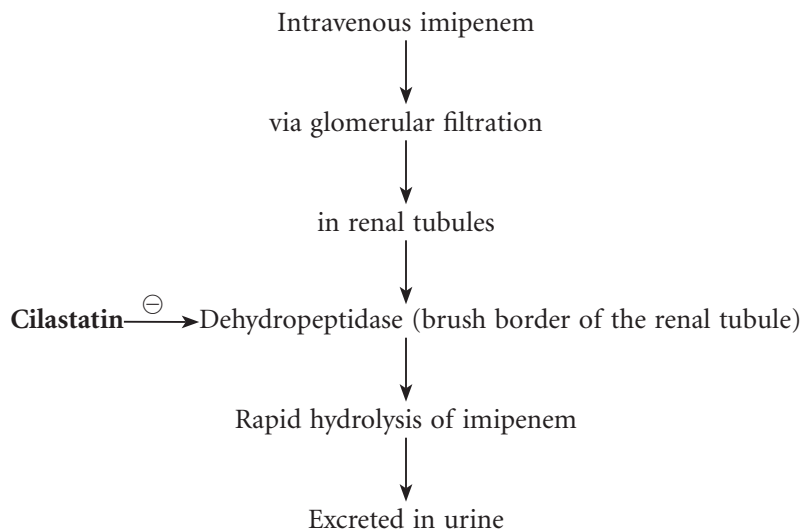

Cilastatin, a dehydropeptidase inhibitor, increases the concentration of imipenem in urine. Hence, it is combined with imipenem.

Imipenem–cilastatin combination increases the antibacterial efficacy and is used in mixed bacterial infections, such as urinary, respiratory, intra-abdominal, gynaecologic, skin, soft tissue, bone and joint infections. It may exhibit cross-reactivity with penicillins and cephalosporins. Nausea, vomiting and skin rashes are the common side effects and, rarely, seizures have also been reported.

Other carbapenems*Meropenem*

- Injected intravenously.
Not destroyed by dehydropeptidase – does not require cilastatin coadministration
- Seizures less likely
- Also effective against imipenem resistant *P. aeruginosa*.

Faropenem

- Orally effective.
- Used for respiratory and genitourinary infections.

MONOBACTAMS

Aztreonam is a β -lactam antibiotic with **only** one ring in its structure, hence the name monobactam. It also acts by inhibiting the bacterial cell wall synthesis. It is effective **only** against gram-negative bacteria, such as Enterobacteriaceae, *P. aeruginosa*, gonococci and *H. influenzae* but has no activity against gram-positive bacteria and anaerobes. It is resistant to most β -lactamases. It is administered **only** parenterally (i.m., i.v.). The main advantage with aztreonam is lack of cross-reactivity with other β -lactam antibiotics (except with ceftazidime). It is useful for the treatment of hospital-acquired-gram-negative infections (genitourinary, intra-abdominal, etc.).

Key Points for Dentists

- Rule out any history of drug /food allergy and previous exposure to penicillins.
- An intradermal test should be done before administering injection penicillin.
- Incidence of anaphylactic shock is more with natural penicillins.
- Observe the patient for at least 30–60 min after penicillin injection.
- Beta lactam antibiotics (penicillins, cephalosporins, carbapenams and monobactams) are safe for use in pregnancy.
- Procaine penicillin G and benzathine penicillin G should not be injected intravenously.

AMINOGLYCOSIDES

They include streptomycin, gentamicin, tobramycin, amikacin, kanamycin, sisomicin, neomycin, framycetin and netilmicin.

Common properties of aminoglycosides

1. They contain two or more **amino sugars** attached by glycosidic linkage to hexose ring.
2. They are highly polar compounds, hence, **poorly absorbed** from the GI tract. They are administered by **parenteral** route (i.m./i.v.) for systemic effect.
3. They are mainly **distributed** into extracellular fluid and poorly penetrate into the CSF.
4. They are **not metabolized** in the body.
5. They are **excreted** unchanged in urine.
6. They have **bactericidal** action against gram-negative aerobes and are more active at alkaline pH.
7. They exhibit **ototoxicity** and **nephrotoxicity**.
8. They exhibit partial **cross-resistance** among them.
9. Transport of aminoglycosides into the bacterial cell requires oxygen; hence **anaerobes are resistant** to aminoglycosides.

Mechanism of action

Aminoglycosides are bactericidal agents—inhibit protein synthesis.

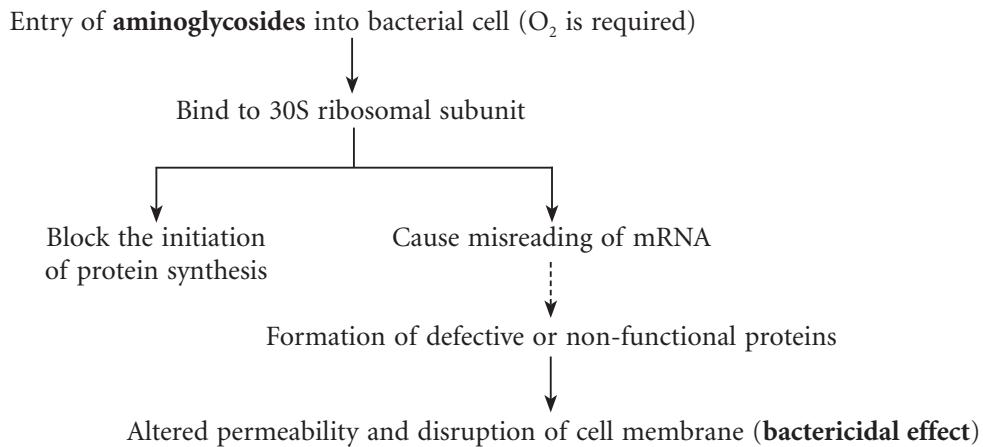

Mechanisms of bacterial resistance

Bacterial resistance to aminoglycosides is due to (i) inactivation of the drug by bacterial enzymes (ii) decreased entry of drug into bacterial cell and (iii) decreased affinity of the drug for the ribosomes.

Aminoglycosides exhibit

1. A concentration-dependent killing effect—higher the plasma concentration, more of the bacteria is killed rapidly.
2. A postantibiotic effect—bactericidal effect is present even when serum concentration falls below minimum inhibitory concentration (MIC). Therefore, once-daily dosing regimen is effective.

Dosing

1. Once-daily dosing regimen—total daily dose is given as a single injection. It is preferred because it:
 - is as effective as multiple-dose regimen.
 - is safer than multiple-dose regimen.
 - is convenient.
2. Multiple-daily-dosing regimen—the total daily dose is administered in two or three equally divided doses.

Once-daily dosing regimen is not preferred in bacterial endocarditis. Dose adjustment of aminoglycosides is done according to body weight and creatinine clearance.

Adverse effects

1. **Ototoxicity:** Vestibular and cochlear dysfunctions can occur due to VIIIth cranial nerve damage. They get concentrated in the perilymph and endolymph of the inner ear, which can lead to progressive damage to vestibular and cochlear hair cells. The manifestations are tinnitus and deafness, headache, dizziness, nausea, vomiting, vertigo, nystagmus and ataxia. The adverse effect is reversible if the drug is discontinued early.

The important risk factors for ototoxicity are:

- a. Elderly patients.
 - b. Repeated courses of aminoglycosides.
 - c. Patients with pre-existing auditory impairment.
 - d. Concurrent use of other ototoxic drugs such as vancomycin, minocycline, loop diuretics, etc.
2. **Nephrotoxicity:** Aminoglycosides get concentrated in the renal cortex and produce nephrotoxicity, which is usually reversible. The incidence of nephrotoxicity is highest with neomycin and least with streptomycin. The risk factors for nephrotoxicity are elderly patients, pre-existing renal disease and concurrent use of other nephrotoxic drugs such as AMB, vancomycin, cisplatin, cyclosporine, etc.
 3. **Neuromuscular blocking effect:** Apnoea and muscular paralysis have been reported. They inhibit the release of acetylcholine from the motor nerve. Myasthenic patients are more susceptible to neuromuscular blocking effect of these drugs, hence should be avoided.
 4. **Hypersensitivity reactions** are rare; occasionally skin rashes, drug fever and eosinophilia can occur. Cross sensitivity between aminoglycosides may occur.
 5. Use of aminoglycosides during pregnancy may cause ototoxicity in the foetus.

■ Streptomycin

Streptomycin was the first aminoglycoside discovered in 1944. The common properties, mechanism of action and adverse effects are explained above.

Uses

Streptomycin is one of the first-line drugs for tuberculosis and is used in combination with other antitubercular drugs. The other uses include tularaemia, plague and brucellosis.

■ Gentamicin

It is the most commonly used aminoglycoside antibiotic for aerobic gram-negative bacillary infections due to *E. coli*, *Klebsiella*, *Proteus*, *Enterobacter* and *P. aeruginosa*. It is also effective against gram-positive infections—enterococci, *S. viridans* and staphylococci but not *M. tuberculosis*. It is available for parenteral and topical administration. Common properties, mechanism of action and adverse effects are discussed above.

Therapeutic uses of gentamicin

Among aminoglycosides, gentamicin is the most commonly used because it is cheap and effective against most of the aerobic gram-negative bacilli.

1. In dentistry

Prophylaxis of bacterial endocarditis: Gentamicin can be used in combination with amoxicillin/vancomycin for the prophylaxis of endocarditis in high-risk patients before dental or other surgical procedures.

Combination broadens the spectrum of activity, produces synergistic effect and decreases emergence of resistance.

- Penicillin G + gentamicin for *S. viridans*.
- Ampicillin + gentamicin for *Enterococcus*.
- Vancomycin + gentamicin for *Enterococcus* (patients allergic to β -lactam antibiotics).

2. Severe aerobic gram-negative bacillary infections

- Urinary tract infection with pyelonephritis
- Pneumonia
- Meningitis
- Osteomyelitis
- Septicaemia
- Infected burns

} Due to *Pseudomonas*, *Klebsiella*,
E. coli, *Proteus*, etc.

3. **Other gram-negative infections:** Gentamicin can be used in plague, brucellosis and tularaemia, either alone or in combination with a tetracycline.
4. Gentamicin is used topically for gram-negative skin, eye and ear infections.

■ Neomycin

It is highly nephrotoxic, hence never used for systemic effect. It is used only for local effect. The common properties, mechanism of action and adverse effects are as for other aminoglycosides. Neomycin is often used topically in combination with bacitracin or polymyxin B for wounds, ulcers, burns, and infections of eye and ear. It can be used orally for preparation of the bowel before abdominal surgery and in hepatic encephalopathy.

■ Framycetin (Soframycin)

Like neomycin, framycetin is also highly nephrotoxic, hence not used for systemic administration. The common properties, mechanism of action and adverse effects are similar to other aminoglycosides. Framycetin is widely used topically for skin, eye and ear infections.

■ Amikacin

Amongst the aminoglycosides, it has the broadest spectrum of activity. It is resistant to aminoglycoside-inactivating enzymes. It is useful for the treatment of nosocomial gram-negative infections and tuberculosis.

■ Tobramycin

All features are similar to gentamicin. It is superior to gentamicin against *P. aeruginosa*— useful in the treatment of serious infection by this organism.

■ Netilmicin

It is resistant to aminoglycoside-inactivating enzymes, hence effective against most of the gentamicin-resistant bacteria.

Key Points for Dentists

- Gentamicin should not be mixed with other drugs in the syringe or i.v.-infusion bottle, as that may result in precipitation or inactivation of drugs.
- Dose adjustment of gentamicin should be done in patients with renal failure.

BROAD-SPECTRUM ANTIBIOTICS

Tetracyclines and chloramphenicol are broad-spectrum antibiotics. They are called so because of their effectiveness against a wide range of microorganisms such as

- gram-positive and gram-negative cocci—*S. aureus*, *S. pneumoniae*, *N. gonorrhoea*.
- gram-negative bacilli—*V. cholerae*, *H. ducreyi*, *H. influenzae*, *H. pylori*, *Campylobacter*, *Yersinia pestis*.
- gram-positive bacilli—*B. anthracis*, *Listeria*, *Clostridia*, *Propionibacterium acnes*.
- Others: *Rickettsiae*, *Mycoplasma*, *Chlamydia*, *Actinomyces*, *Plasmodia*, *Entamoeba histolytica*.

TETRACYCLINES

Tetracyclines have four cyclic rings in their structure (Fig. 11.8).

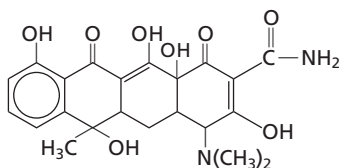
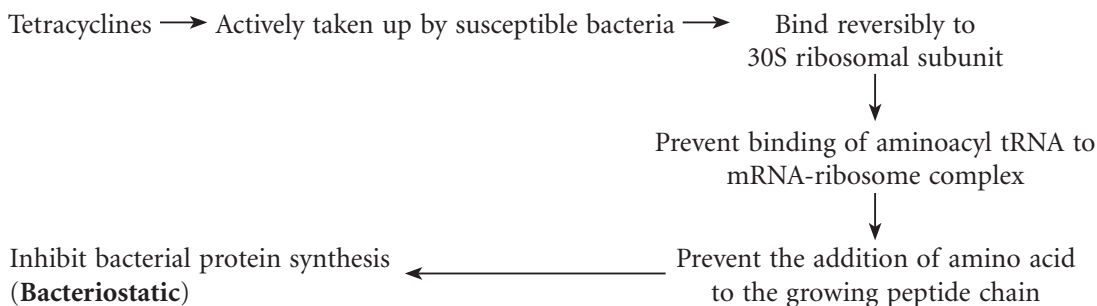

Fig. 11.8 Basic structure of tetracycline.

Mechanism of action



Resistance

Bacterial resistance to tetracyclines is due to: (i) decreased influx or increased efflux of tetracyclines (ii) inactivation of the drug by enzymes.

Pharmacokinetics

The older tetracyclines are incompletely absorbed after oral administration (Table 11.10), but that is adequate to produce antibacterial activity. Food interferes with the absorption of all tetracyclines; doxycycline and minocycline are less affected. Tetracyclines have chelating property; hence, they form stable insoluble and unabsorbable complexes with calcium, magnesium, iron and other metal ions. Therefore, the absorption of tetracyclines is reduced by simultaneous administration with dairy products, antacids, iron, sucralfate and zinc salts. Tetracyclines are widely distributed throughout the body, get concentrated in liver, spleen, bone, dentine, enamel of unerupted teeth but concentration in CSF is relatively low. They cross placental barrier, are metabolized in liver and excreted in urine. Doxycycline is excreted mainly in the faeces via bile. Therefore, doxycycline is safe for use in patients with renal insufficiency. Doxycycline undergoes enterohepatic cycling.

Table 11.10 Important Features of Tetracyclines

Drugs	Route of Administration	Absorption from the Gut (%)	Dosage
Chlortetracycline } Oxytetracycline } Tetracycline }	Oral, i.v., topical	Incomplete	250–500 mg QID
Demeclocycline } Methacycline }	Oral	Incomplete	300– 600 mg BD
Doxycycline } Minocycline }	Oral, i.v.	High	100 mg BD or OD

Adverse effects

1. **Gastrointestinal:** On oral administration, they can cause GI irritation manifested as nausea, vomiting, epigastric distress, abdominal discomfort and diarrhoea.
2. **Effects on bones and teeth:** Tetracyclines have calcium-chelating property, form tetracycline–calcium orthophosphate complex, which is deposited in growing bone and teeth. Use of tetracyclines in children and during pregnancy can cause permanent brownish discolouration of the deciduous teeth due to deposition of the chelate in the teeth. There is increased incidence of caries in such teeth. Tetracyclines also affect the linear growth of bones. The incidence of hepatotoxicity is more in pregnant women. Therefore, tetracyclines are contraindicated during pregnancy in the interest of both foetus and mother. It is also contraindicated in children up to the age of 8 years.
3. **Phototoxicity:** It is particularly seen with demeclocycline and doxycycline. They may also produce sunburn-like reaction in the skin on exposure to sunlight. They may also produce pigmentation of the nails.
4. **Superinfection:** It is common with older tetracyclines because of their incomplete absorption in the gut; they cause alteration of the gut flora. Superinfection occurs with organisms resistant to tetracyclines like *Candida*, *Proteus*, *Pseudomonas*, *C. difficile*, etc. Pseudomembranous colitis caused by *C. difficile* is a serious complication. It is characterized by severe diarrhoea, fever, abdominal pain and stool mixed with blood and mucus, which is treated with oral metronidazole (see p. 297–298).
5. **Hepatotoxicity:** Acute hepatic necrosis with fatty changes is common in patients receiving high doses (>2 g/day) intravenously. It is more likely to occur in pregnant women.
6. **Renal toxicity:** Demeclocycline may produce nephrogenic diabetes insipidus by inhibiting the action of antidiuretic hormone (ADH) on collecting duct.
Fanconi syndrome: Use of outdated tetracyclines may damage the proximal renal tubules—the patient may present with nausea, vomiting, polyuria, proteinuria, acidosis, etc.
7. **Hypersensitivity reactions:** Skin rashes, fever, urticaria, exfoliative dermatitis, etc. may occur rarely. Cross-sensitivity among tetracyclines is common.

Therapeutic uses

1. **In dentistry:** Tetracyclines are used as an adjuvant in chronic periodontitis refractory to other antibiotics. Doxycycline is useful for subgingival plaque as it:
 - a. gets concentrated in gingival fluid.
 - b. inhibits collagenase enzyme and prevents destruction of connective tissue in the gum.
Tetracyclines may be effective in the treatment of acute necrotizing gingivitis or periodontitis, either alone or in combination with metronidazole.

2. **Rickettsial infections:** Tetracyclines are the first-choice drugs for the treatment of rickettsial infections. Doxycycline is given orally or intravenously for 5–7 days.
3. **Mycoplasma pneumoniae infections:** Doxycycline or macrolides are used to shorten the duration of illness.
4. **Chlamydial infections:** Lymphogranuloma venereum is a sexually transmitted infection caused by *C. trachomatis*. Doxycycline is the drug of choice. Macrolides are also effective.
5. **Cholera:** Fluid and electrolyte replacement is the mainstay of therapy. Single dose of tetracycline or doxycycline is effective in adults. It reduces the stool volume.
6. **Brucellosis:** It is treated with a combination of doxycycline with rifampin or gentamicin or streptomycin.
7. **Plague:** Doxycycline is highly effective.
8. **Anthrax and leptospirosis:** Doxycycline is useful for the prevention and treatment of these diseases.
9. **Lyme disease:** It is caused by a spirochete and can be treated successfully with doxycycline.
10. **Granuloma inguinale:** It is a sexually transmitted disease. Doxycycline is effective.
11. **Acne:** Low doses of tetracyclines are used.

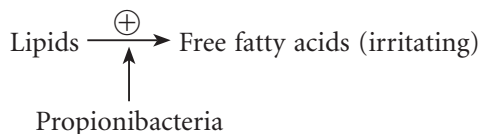

Tetracyclines act by inhibiting propionibacteria, thereby prevent the formation of free fatty acids.

12. **Malaria:** Doxycycline is used in combination with other antimalarial agents for treatment of chloroquine-resistant *P. falciparum* malaria. It is used alone for malarial chemoprophylaxis.

Advantages of doxycycline

1. It can be administered orally as well as intravenously.
2. It is highly potent.
3. It is completely absorbed after oral administration.
4. Food does not interfere with its absorption.
5. It has a longer duration of action ($t/2=24$ h).
6. Incidence of diarrhoea is rare as it does not affect the intestinal flora.
7. It can be safely given to patients with renal failure, as it is excreted primarily in bile.

Key Points for Dentists

- Tetracyclines are contraindicated in children up to the age of 8 years, as they cause permanent brownish discolouration of the deciduous teeth.
- Use of outdated tetracyclines can cause renal damage.
- Doxycycline can be safely used in patients with renal failure.
- Tetracyclines should not be used in pregnancy.

CHLORAMPHENICOL

Chloramphenicol, a broad-spectrum antibiotic, was isolated from *Streptomyces venezuelae*. Even though chloramphenicol has a broad spectrum of antibacterial activity, its use is limited to only a few conditions because of its dangerous side effect—bone marrow suppression.

Mechanism of action

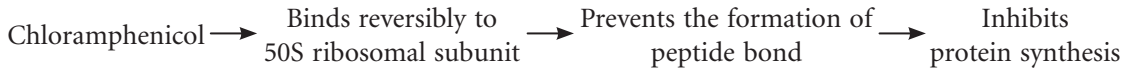

Chloramphenicol is a bacteriostatic agent, but at high concentration, it can be bactericidal against *H. influenzae*, *N. meningitidis* and *S. pneumoniae*. It can also inhibit mitochondrial protein synthesis in mammalian cells by acting on 70S ribosomes.

Resistance to chloramphenicol is caused by:

1. Production of inactivating enzyme—acetyltransferase, e.g. *H. influenzae*, *S. typhi*, *S. aureus*, etc.
2. Decreased permeability of the microbial cell wall.
3. Ribosomal mutation.

Pharmacokinetics

Chloramphenicol is commonly given by oral route and is rapidly absorbed from the gut. It is also available for parenteral and topical administration. Chloramphenicol is widely distributed to all tissues including CSF and brain. It also crosses the placental barrier and is secreted in milk. It gets metabolized in liver by glucuronide conjugation, and the metabolite is excreted mainly in urine.

Adverse effects

Most of the adverse effects of chloramphenicol are due to inhibition of mammalian mitochondrial protein synthesis.

1. **Hypersensitivity reactions:** Skin rashes, drug fever and angioedema may occur rarely.
2. **Bone marrow suppression:** The most serious adverse effect of chloramphenicol is on the bone marrow. It can occur in two ways:
 - a. Dose-dependent reversible suppression of bone marrow, which manifests as anaemia, leukopenia and thrombocytopenia.
 - b. Idiosyncratic non-dose-related irreversible aplastic anaemia, which is often fatal.
3. **Gastrointestinal effects:** These include nausea, vomiting and diarrhoea. Prolonged use may cause superinfection due to suppression of gut flora.
4. **Gray baby syndrome:** In neonates, especially in premature babies, chloramphenicol can cause a dose-related gray baby syndrome due to reduced degradation and detoxification of the drug in liver because of the deficiency of glucuronyl transferase enzyme. The manifestations are nausea, vomiting, abdominal distension, diarrhoea, refusal to suck, cyanosis, irritability and circulatory collapse. The skin appears ashen gray colour, hence the name 'gray baby' syndrome. Mortality is high. Therefore, chloramphenicol should be avoided in neonates.

Therapeutic uses

1. **Typhoid fever:** Chloramphenicol was used for typhoid. Antibiotics useful are third-generation cephalosporins, fluoroquinolones, azithromycin, ampicillin, cotrimoxazole, etc. *S. typhi* has developed resistance to most of the antibiotics. Now, fluoroquinolones (ciprofloxacin, ofloxacin, levofloxacin, etc.) or third-generation cephalosporins (ceftriaxone, cefoperazone) are the drugs of choice for typhoid fever.
2. **Bacterial meningitis:** Third-generation cephalosporins are the preferred drugs for the treatment of bacterial meningitis caused by *H. influenzae*, *N. meningitidis* and *S. pneumoniae*. However, chloramphenicol can be used alone or in combination with ampicillin.

3. **Anaerobic infections:** Chloramphenicol is effective against most anaerobic bacteria including *B. fragilis*. It is often used in combination with metronidazole for the treatment of brain, lung, intra-abdominal or pelvic abscesses.
4. **Rickettsial infections:** Tetracyclines are the drug of choice for the treatment of rickettsial diseases. Chloramphenicol can be used to treat rickettsial infections in children and pregnant women.
5. **Eye and ear infections:** Chloramphenicol is used topically for eye and ear infections due to susceptible organisms.

MACROLIDES

Macrolides have a many-membered lactone ring with attached sugars. Erythromycin was obtained from *Streptomyces erythreus*. Roxithromycin, clarithromycin and azithromycin are semisynthetic macrolides.

Mechanism of action

Erythromycin and other macrolides bind to bacterial 50S ribosomal subunit and inhibit protein synthesis. They are bacteriostatic but at high concentrations, they can act as bactericidal agents. They are more active in alkaline pH.

Pharmacokinetics

Erythromycin is adequately absorbed from the upper GI tract. It is destroyed by gastric acid (acid labile), hence, must be administered as Enteric-coated tablets to protect it from gastric acid. Food may delay the absorption of erythromycin. It is widely distributed in the body and reaches therapeutic concentration in prostatic secretions but does not cross BBB. It is partly metabolized in liver and excreted in bile.

Preparations of erythromycin

They are erythromycin base, erythromycin Estolate and erythromycin stearate.

Adverse effects

1. The common side effects are related to GI tract (Enteral toxicity): Nausea, vomiting, Epigastric pain and diarrhoea. Erythromycin increases GI motility by stimulating the motilin receptors in the gut.
2. Hypersensitivity reactions: Skin rashes, drug fever, eosinophilia and hepatitis with cholestatic jaundice, particularly with erythromycin estolate. The incidence of hepatotoxicity is more in pregnant women.

Erythromycin
Enteric-coated tablets
Erythromycin Estolate
Enteral toxicity mainly
Enzyme inhibitor

Drug interactions

Erythromycin and clarithromycin are Enzyme inhibitors; hence, they increase the blood levels of number of drugs such as theophylline, carbamazepine, valproate, warfarin, digoxin, cyclosporine, etc. and potentiate their effects. Erythromycin and clarithromycin can precipitate fatal ventricular arrhythmias when given with cisapride, astemizole, terfenadine, etc.—such interactions are not seen with azithromycin.

Drawbacks of erythromycin

1. It has a narrow spectrum of antibacterial activity.
2. Its oral bioavailability is low.
3. It has a short duration of action.
4. Poor patient compliance due to GI side effects.

To overcome the above drawbacks, semisynthetic macrolides—roxithromycin, clarithromycin and azithromycin—have been developed (Table 11.11).

Clarithromycin (see Table 11.11): Mechanism of action and spectrum of activity is similar to erythromycin. It is administered orally; achieves high concentration inside the cells. It is also used for the treatment of MAC, leprosy and *H. pylori* infection.

Azithromycin (see Table 11.11): It can be administered orally and intravenously. Oral administration should be either 1 h before or 2 h after food. It does not cross blood–brain barrier. Azithromycin is more active against *H. influenzae* than erythromycin and clarithromycin. It has a wide tissue distribution and achieves high intracellular concentration. It is better-tolerated and longer acting (single daily dose) than erythromycin.

Table 11.11 Comparative Features of Macrolides

	Erythromycin	Roxithromycin	Clarithromycin	Azithromycin
1. Source	Natural	Semisynthetic	Semisynthetic	Semisynthetic
2. Duration of action	Short acting (6 h)	Long acting (12 h)	Long acting	Long acting
3. GI absorption	Incomplete	Good	Good, but undergoes first-pass metabolism	Good
4. Acid labile/stable	Acid labile, hence administered as enteric-coated tablets	Acid stable	Acid stable	Acid stable
5. Antibacterial spectrum and therapeutic uses	Narrow spectrum Uses (see below)	Almost similar to erythromycin	Expanded antibacterial spectrum—effective against <i>Mycobacterium avium</i> complex (MAC), <i>Mycobacterium leprae</i> , <i>Helicobacter pylori</i> , <i>T. gondii</i> , etc. in addition to organisms sensitive to erythromycin	Expanded antibacterial spectrum—effective against MAC, <i>H. influenzae</i> , <i>Salmonella</i> , malaria, <i>T. gondii</i> , etc. in addition to organisms sensitive to erythromycin
6. Dosage and duration of therapy	250–500 mg oral QID for 7 days	150 mg BD half-an-hour before food for 7 days	250 mg BD for 1–2 week	500 mg OD 1 h before or 2 h after food for 3–5 days
7. Enzyme inhibitor	Yes, causes various drug interactions	No, drug interactions are rare	Yes, drug interactions are same as erythromycin	No, drug interactions are rare

Antibacterial spectrum and therapeutic uses of macrolides

- In dentistry:** Macrolides are alternatives to penicillins to treat orodental infections in patients allergic to β -lactam antibiotics. They can be used for treatment as well as prophylaxis of dental infections—gingivitis, periodontitis, orodental abscess, postextraction infections, etc. due to aerobic as well as anaerobic gram-positive bacteria. Azithromycin is preferred because of wider spectrum of activity, high intracellular concentration, better tolerability and single daily dosing (azithromycin 500 mg o.d. orally for 3–5 days).

2. **As a drug of choice in the following conditions:**

- a. *M. pneumoniae* infections: Azithromycin and clarithromycin are often used for the treatment of community-acquired pneumonia. Erythromycin can also be used.
- b. *Legionnaires' pneumonia*: Macrolides, especially azithromycin, are the drug of choice because of high tissue concentration, excellent activity, better tolerability and single daily dosing.
- c. Chlamydial infections: Macrolides are preferred for chlamydial infections in children and pregnant women.
- d. Diphtheria: Erythromycin is very effective for eliminating the carrier state and for the treatment of acute infection.
- e. Pertussis (whooping cough): Erythromycin is most effective for the treatment as well as for prophylaxis of close contacts. Clarithromycin and azithromycin are also effective.

3. **As an alternative drug in patients who are allergic to penicillin**

- a. *Prophylactic uses*:
 - Before dental procedures to prevent bacterial endocarditis in patients with valvular lesion—azithromycin (500 mg PO 1 h before the procedure) can be used.
 - For prophylaxis of recurrences of rheumatic fever.
- b. *Tetanus*: Administration of human tetanus antitoxin, tetanus toxoid, anticonvulsant (e.g. diazepam) and debridement of wound are the important therapeutic measures. A course of oral erythromycin for 10 days may be given to eradicate *C. tetani*.
- c. *Streptococcal infections*: Tonsillitis, pharyngitis, otitis media, cellulitis, pneumonia, etc. respond to azithromycin and erythromycin.

Note: Mnemonic—MLCDPTS (uses).

Key Points for Dentists

- Macrolides are safe for use in pregnancy.
- They are alternatives to penicillins to treat infections in patients allergic to β -lactam antibiotics.
- Azithromycin can be used for prophylaxis of endocarditis prior to dental procedures in patients with cardiac diseases.

ANTIPSEUDOMONAL AGENTS (DRUGS USED IN PSEUDOMONAL INFECTIONS)

β -Lactam antibiotics

Antipseudomonal penicillins: Carbenicillin, carbenicillin indanyl, ticarcillin, piperacillin–tazobactam, mezlocillin.

Cephalosporins: Cefoperazone, ceftazidime, cefepime.

Carbapenems: Imipenem, meropenem, doripenem, ertapenem.

Monobactams: Aztreonam.

Aminoglycosides

Gentamicin, amikacin, tobramycin, netilmicin, sisomicin

Fluoroquinolones

Ciprofloxacin, levofloxacin

Sulphonamides

Silver sulfadiazine*, mafenide*

Others

Polymyxin B*, colistin*

DRUGS USED IN ANAEROBIC INFECTIONS**Nitroimidazoles**

Metroimidazole, tinidazole, etc.

Beta-lactam antibiotics*Penicillins*: Penicillin G (except for *B. fragilis*); piperacillin and tazobactam; ticarcillin and clavulanic acid.*Cephalosporins*: Cefoxitin, cefotetan, ceftizoxime.*Carbapenems*: Imipenem, ertapenem, meropenem, doripenem.**Fluoroquinolones**

Ciprofloxacin, moxifloxacin

Broad-spectrum antibiotics

Chloramphenicol

Sulphonamides

Mafenide*

Others

Vancomycin, clindamycin

MISCELLANEOUS ANTIBACTERIAL AGENTS

Miscellaneous antibacterial agents have been discussed in Table 11.12.

Table 11.12 Miscellaneous Antibacterial Agents (See Also Figs 11.9 and 11.10)

Drug with Mechanism of Action	Antibacterial Spectrum	Pharmacokinetics	Uses	Adverse effects
Clindamycin (lincosamide) inhibits protein synthesis by binding to 50S subunit of bacterial ribosomes (bacteriostatic)	Gram-positive cocci, anaerobes (<i>Bacteroides fragilis</i>), <i>P. jiroveci</i> , <i>T. gondii</i>	Administered by oral, i.m., i.v. and topically; widely distributed in the body including bones, poorly crosses BBB	1. Anaerobic infections due to <i>B. fragilis</i> (dentoalveolar and other abscesses) 2. Prophylaxis of endocarditis before dental procedures in patients allergic to penicillins	Skin rashes, Pseudomembranous colitis (superinfection)—diarrhoea with blood and mucus in the stools due to <i>Clostridium difficile</i> . The drug should be stopped immediately. It is treated with metronidazole (drug of choice) or vancomycin

(Contd...)

*Topical agents

Table 11.12 Contd...

Drug with Mechanism of Action	Antibacterial Spectrum	Pharmacokinetics	Uses	Adverse effects
Linezolid: Inhibits protein synthesis by binding to 50S ribosomal subunit bacteriostatic except against Streptococci (bactericidal)	Gram-positive organisms—streptococci and staphylococci including MRSA, VRSA, VRE and Listeria	Administered by oral and i.v. infusion	Skin and soft-tissue infections, nosocomial (hospital acquired) infections	GI side effects—nausea, vomiting and diarrhoea; bone marrow suppression
Vancomycin: Inhibits bacterial cell wall synthesis (bactericidal)	Gram-positive cocci: <i>S. aureus</i> including MRSA, <i>S. epidermidis</i> , <i>S. pyogenes</i> , <i>S. pneumoniae</i> , <i>S. viridans</i> and <i>Enterococcus</i> . Gram-positive bacilli: diphtheroids and <i>Clostridium</i> spp.	Poorly absorbed after oral administration, hence used intravenously for systemic infections. Orally for antibiotic-associated colitis (for local action)	1. Endocarditis due to <i>S. viridans</i> or enterococci: Vancomycin is used in combination with aminoglycoside in patients allergic to penicillin 2. MRSA infections: Pneumonia, endocarditis, osteomyelitis, etc. 3. Orally for pseudomembranous colitis caused by <i>C. difficile</i> or staphylococci	Highly toxic, causes ototoxicity, nephrotoxicity and hypersensitivity reactions (skin rashes and anaphylaxis). Rapid i.v. infusion may cause shock-like state with flushing, fever, chills, tachycardia and hypotension—'red-man' syndrome due to release of histamine
Teicoplanin: Inhibits bacterial cell wall synthesis (bactericidal)	Similar to vancomycin	Administered by i.m. or i.v. injection	MRSA and enterococcal infections; for severe infections teicoplanin is used in combination with gentamicin	Skin rashes, drug fever and rarely hypersensitivity reactions may occur
Fusidic acid (bacteriostatic)	Gram-positive bacteria including <i>S. aureus</i>	—	Used topically for staphylococcal infections—boils, folliculitis, angular cheilitis, etc.	Skin rashes

MRSA: methicillin-resistant *S. aureus*; VRSA: vancomycin-resistant *S. aureus*; VRE: vancomycin-resistant *Enterococcus*.

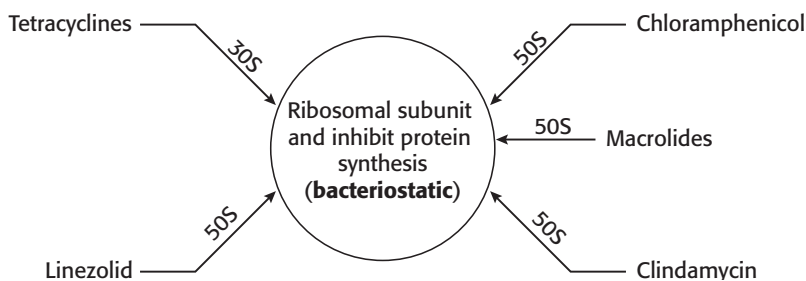

Fig. 11.9 AMAs inhibit protein synthesis by binding to either 50S or 30S ribosomal subunit (see also Table 11.12).

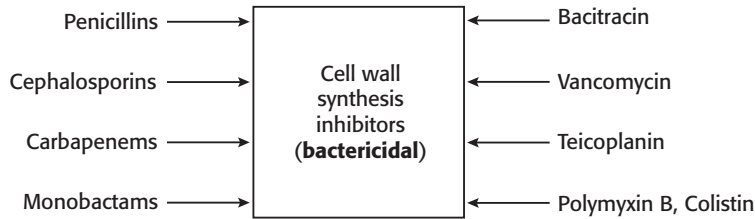

Fig. 11.10 AMAs that inhibit bacterial cell wall synthesis (see also Table 11.12).

Key Points for Dentists

- Vancomycin with gentamicin is useful prior to dental procedures for prophylaxis of bacterial endocarditis in patients allergic to beta-lactams.
- Clindamycin should be used with caution because of the risk of pseudomembranous colitis.

ANTITUBERCULAR DRUGS

Tuberculosis (TB) is a chronic infectious disease caused by *M. tuberculosis*, an acid-fast bacillus (AFB).

Mycobacterial infections require prolonged treatment. Since TB is a chronic infection, it consists of excessive fibrous tissue with central necrosis. So vascularity of the lesion is poor; hence, the penetration of the drug into the lesion is decreased.

Classification

1. **First-line antitubercular drugs (standard drugs)**
Isoniazid (H), rifampin (R), pyrazinamide (Z), ethambutol (E), streptomycin (S).
2. **Second-line antitubercular drugs (reserve drugs)**
Para-aminosalicylic acid, thiacetazone, cycloserine, ethionamide, kanamycin, capreomycin, amikacin.
3. **Others:** Ciprofloxacin, levofloxacin, moxifloxacin, ofloxacin, clarithromycin, rifabutin, rifapentine.

■ First-line Antitubercular Drugs

They are cheap, more effective, routinely used and less toxic.

● Isoniazid [Isonicotinic Acid Hydrazide (INH)]

Isoniazid is a highly effective and the most widely used antitubercular agent. It is orally effective, cheapest and has tuberculocidal activity. It is active against both intracellular and extracellular bacilli. It is a first-line drug for the treatment of tuberculosis. It is also used for chemoprophylaxis of tuberculosis.

Mechanism of action

Isoniazid inhibits the biosynthesis of mycolic acids, which are essential constituents of the mycobacterial cell wall.

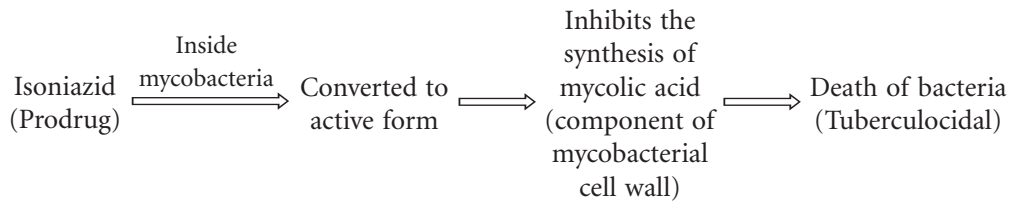

Pharmacokinetics

INH is readily absorbed from the gut, distributed well all over the body, tubercular cavities and body fluids like CSF; it also crosses placental barrier. It is metabolized by acetylation and the metabolites are excreted in urine. The rate of acetylation of INH is under genetic control resulting in either rapid or slow acetylators.

Uses

Isoniazid (INH) is a first-line drug for the treatment of TB. It is also used for chemoprophylaxis of TB.

Adverse effects and drug interactions

1. **Hepatotoxicity:** The risk of hepatic damage is more in chronic alcoholics, older people and rapid acetylators. It is reversible on discontinuation of the drug. Patients receiving INH should be monitored for symptoms like anorexia, nausea, vomiting, jaundice, etc.
2. **Peripheral neuritis:** It is a dose-related toxicity. INH is structurally similar to pyridoxine; hence, INH competitively interferes with utilization of pyridoxine. It also promotes the excretion of pyridoxine. Peripheral neuritis is more common in slow acetylators. Pyridoxine 10 mg/day is routinely given along with INH to reduce the risk of peripheral neuritis. It is also used for the treatment of INH-induced peripheral neuritis.
3. Other side effects are fever, skin rashes, arthralgia, anaemia, GI disturbances, psychosis and rarely convulsions.
Isoniazid inhibits the metabolism of phenytoin, carbamazepine, warfarin, etc. → increases the plasma levels of these drugs → may result in toxicity.

Rifampin (Rifampicin)

Rifampin is a derivative of rifamycin and is a first-line antitubercular drug. It rapidly kills intracellular and extracellular bacilli including spurters (those residing in caseous lesion). It is the only agent that can act on all types of bacillary subpopulations; hence rifampin is called sterilizing agent.

Mechanism of action

Rifampin binds to bacterial DNA-dependent RNA polymerase and inhibits RNA synthesis. It has bactericidal effect against mycobacteria, *N. meningitidis*, *H. influenzae*, *S. aureus*, *E. coli*, *Pseudomonas*, etc.

Pharmacokinetics

It is given orally and is rapidly absorbed from the GI tract, but presence of food reduces its absorption; it is distributed widely throughout the body and gets metabolized in liver. The active deacetylated form is excreted in bile and undergoes enterohepatic recycling. The rest of the drug is excreted in urine.

Uses

1. **Tuberculosis:** Rifampin is used along with INH and other antitubercular drugs for the treatment of tuberculosis. It is also used for chemoprophylaxis of tuberculosis.
2. **Leprosy** (see pp. 338 and 339).

3. **Prophylaxis of meningococcal and *H. influenzae meningitis***: Rifampin reaches high concentration in the nasopharynx and eradicates the carrier state in case of meningococcal and *H. influenzae* infections.
4. Rifampin in combination with β -lactam antibiotics may be useful in **staphylococcal infections** such as endocarditis, osteomyelitis, etc.
5. Rifampin is used with doxycycline for the treatment of **brucellosis**.

Adverse effects and drug interactions

1. Hepatitis is the main adverse effect—the risk of hepatotoxicity is more in alcoholics and elderly patients.
2. Flu-like syndrome with fever, chills, headache, muscle and joint pain.
3. GI disturbances such as nausea, vomiting and abdominal discomfort.
4. Skin rashes, itching and flushing.

It stains various body fluids such as urine, tears, saliva, sweat, sputum, etc. orange red, which is harmless.

Rifampin is a potent microsomal enzyme inducer, hence reduces the plasma levels of number of drugs such as oral contraceptives (resulting in contraceptive failure), oral anticoagulants, oral antidiabetic drugs, HIV protease inhibitors and non-nucleoside reverse transcriptase inhibitors (NNRTIs), etc. It also induces its own metabolism.

Pyrazinamide

Pyrazinamide is a synthetic analogue of nicotinamide. It is active in acidic pH—effective against intracellular bacilli (has sterilizing activity). It has tuberculocidal activity. Like INH, pyrazinamide inhibits mycobacterial mycolic acid biosynthesis but by a different mechanism. It is given orally, absorbed well from GI tract and is distributed widely throughout the body including the CSF. It is metabolized in liver and excreted in urine. The most important adverse effect of pyrazinamide is dose-dependent hepatotoxicity. It impairs the excretion of urates resulting in hyperuricaemia and may also precipitate acute attacks of gout in susceptible individuals. The other side effects are anorexia, nausea, vomiting, fever and skin rashes.

Ethambutol

It is a first-line antitubercular drug. It inhibits arabinosyl transferases that are involved in mycobacterial cell wall synthesis. It is a bacteriostatic drug. It is used in combination with other antitubercular drugs to prevent emergence of resistance and for faster sputum conversion. There is no cross-resistance with other antitubercular drugs.

Ethambutol is well absorbed after oral administration, distributed widely in the body, metabolized in liver, crosses BBB in meningitis and excreted in urine. Optic neuritis is the main adverse effect seen with ethambutol, which is characterized by decreased visual acuity and colour-vision defects (red–green). Hence, periodic eye examination is necessary when the patient is on ethambutol. The toxicity is reversible if the drug is discontinued early following onset of symptoms. It should be avoided in children below 6 years of age because they may not be able to report the disturbances in the vision, and it is also difficult to test visual acuity in children. Hyperuricaemia is due to the decreased clearance of urates. Other side effects are nausea, vomiting, abdominal pain, skin rashes, itching and joint pain.

Streptomycin

Streptomycin is an aminoglycoside antibiotic. It is a bactericidal drug. It is active against extracellular bacilli in alkaline pH. Streptomycin is not effective orally; it must be injected intramuscularly. The adverse effects are ototoxicity, nephrotoxicity and neuromuscular blockade.

Second-line Antitubercular Agents

They are less effective, more costly and more toxic than the first-line drugs; hence, they are reserve drugs for tuberculosis.

Para-aminosalicylic Acid (PAS)

It is structurally similar to sulphonamides. Like sulphonamides, PAS also competitively inhibits folate synthetase enzyme and produces tuberculostatic effect. At present, PAS is a reserve drug for the management of MDR-tuberculosis. The common adverse effects are GI disturbances—*anorexia, nausea, vomiting and abdominal discomfort.*

Ethionamide

It is structurally similar to INH but is less efficacious. It inhibits synthesis of mycolic acids. It is a bacteriostatic drug. The adverse effects are *nausea, vomiting and epigastric pain.* Other side effects are *hepatitis, headache, blurred vision and paraesthesia.*

Cycloserine

It is a second-line antitubercular drug with bacteriostatic activity. It inhibits bacterial cell wall synthesis. The common side effects are on CNS and include *headache, tremor, psychosis and convulsions.*

Other Antitubercular Agents

- **Fluoroquinolones:** Ciprofloxacin, moxifloxacin and levofloxacin—bactericidal agents, given orally.
- **Aminoglycosides:** Amikacin and kanamycin—bactericidal agents, administered parenterally.
- **Capreomycin (i.m.):** May cause nephrotoxicity and ototoxicity.
- **Macrolides:** Azithromycin and clarithromycin—given orally.
- **Rifamycins:** Rifapentine and rifabutin—bactericidal agents, given orally.

Rifabutin: It is a derivative of rifampin. Rifabutin is preferred to rifampin for the treatment of tuberculosis in HIV-infected patients on protease inhibitors (PIs) as rifabutin is a less potent enzyme inducer. Rifabutin is also used for the treatment of MAC infection in combination with clarithromycin and ethambutol.

Rifapentine, analogue of rifampin, is also a potent enzyme inducer.

Treatment of Tuberculosis

WHO recommends the use of multi-drug therapy (MDT) for all cases of tuberculosis. The objectives of MDT are:

1. To make the patient non-infectious as early as possible by rapidly killing the dividing bacilli by using three to four bactericidal drugs.
2. To prevent the development of drug-resistant bacilli.

3. To prevent relapse.
4. To reduce the total duration of effective therapy.

The choice of standardized treatment regimens by each country—as recommended by WHO—should be based on their efficacy, effectiveness and availability of financial resources.

Short-course chemotherapy

There are several short-course regimens of 6–9-months duration, which are convenient, highly effective and less toxic. All regimens have two phases—an intensive phase of 2–3 months followed by continuation phase of 4–6 months. An example of short course chemotherapy of 6-months duration is given below.

1. **Intensive phase:** The patient receives intensive treatment with four tuberculocidal drugs daily or thrice weekly for a period 2 months. The main objective of this phase is to render the patient non-contagious.
2. **Continuation phase:** The patient receives two drugs—usually INH and rifampin—daily or thrice weekly for a period of 4 months. This phase helps to eliminate the remaining bacilli and prevents relapse.

Intensive phase: INH (H) 300 mg + Rifampin (R) 450 mg + Pyrazinamide (Z) 1500 mg + Ethambutol (E) 800 mg/Streptomycin (S) 1000 mg + Pyridoxine 10 mg daily for 2 months.

Continuation phase: INH 300 mg + Pyridoxine 10 mg + Rifampin 450 mg daily for 4 months.

Isoniazid, rifampin, pyrazinamide and pyridoxine are administered orally half-an-hour before breakfast. Streptomycin is given intramuscularly.

Table 11.13 Route and Doses of Commonly Used Antitubercular Drugs

Drug (Route)	Recommended Dosage			
	Daily		Three Times Weekly	
	mg/kg	>50 kg	mg/kg	>50 kg
Isoniazid (H)—oral	5 (4–6)	300 mg	10 (8–12)	600 mg
Rifampin (R)—oral	10 (8–12)	600 mg	10 (8–12)	600 mg
Pyrazinamide (Z)—oral	25 (20–30)	1500 mg	35 (30–40)	2000 mg
Ethambutol (E)—oral	15 (15–20)	1000 mg	30 (20–35)	1600 mg
Streptomycin (S)—i.m.	15 (12–18)	1000 mg	15 (12–18)	1000 mg

► The WHO Guidelines for the Treatment of Tuberculosis (Table 11.14)

The regimen recommended for each patient depends on the diagnostic category for each patient. The Revised National Tuberculosis Control Programme (RNTCP) was launched in India in 1997. Under this programme, DOTS (directly observed treatment short course) chemotherapy is being implemented. Out of the WHO-recommended regimens, the thrice-weekly regimen is followed in DOTS. In DOTS, patient is administered drugs under the supervision of a health worker or other trained person to ensure that drugs are actually consumed. The therapy must be supervised and monitored by bacteriological examination. DOTS is the backbone of RNTCP. It is aimed at ensuring patient compliance thus preventing the emergence of drug-resistant tuberculosis.

Specimens for culture and drug susceptibility testing (DST) should be obtained from all previously treated patients at or before start of treatment.

Table 11.14 WHO-recommended Treatment Regimens

Treatment Group	Type of Patient	TB Treatment Regimens		Total Duration (Months)
		Intensive Phase (IP)	Continuation Phase (CP)	
New patients (Category I)	<ul style="list-style-type: none"> New smear positive or smear negative pulmonary tuberculosis New extrapulmonary TB 	2 HRZE or	4 HR	6
		2 H ₃ R ₃ Z ₃ E ₃	4 H ₃ R ₃	6
Previously treated patients (Category II)	<ul style="list-style-type: none"> Sputum positive relapse Sputum positive failure Sputum positive treatment after default 	Retreatment regimen / MDR regimen*		8
		<i>Retreatment regimen</i>		
		2 HRZES + 1 HRZE or 2 H ₃ R ₃ Z ₃ E ₃ S ₃ + 1 H ₃ R ₃ Z ₃ E ₃	5 HRE 5 H ₃ R ₃ E ₃	

The prefix number before a regimen indicates the number of months of treatment. The subscript indicates the number of doses per week; when no subscripts are given, the regimen is daily; H = Isoniazid, R = Rifampicin, Z = Pyrazinamide, E = Ethambutol, S = Streptomycin.

HRZ and E are administered orally. S is given intramuscularly.

*Depending on results of drug susceptibility testing (DST), availability of DST and country specific data on drug resistance.

Multidrug-resistant Tuberculosis (MDR-TB)

It is defined as resistance to both isoniazid and rifampicin with or without resistance to any other anti-TB drugs.

MDR-TB can be treated by either specially designed standardized or individualized regimens. Patients with or highly likely to have MDR-TB should be treated with regimens containing at least four drugs to which organisms are known or presumed to be susceptible. Treatment should be given for at least 18–24 months beyond culture conversion. Each dose of MDR-regimen should be supervised throughout entire duration of treatment.

Extensively Drug-Resistant (XDR) Tuberculosis

Extensively drug-resistant (XDR) tuberculosis is defined as resistance to INH, rifampicin, fluoroquinolone and one of capreomycin/kanamycin/amikacin.

▶ TB Treatment in HIV Patients

Generally, TB treatment is the same for HIV-infected as for non-HIV-infected TB patients. Short-course chemotherapy must be started, once TB is diagnosed. Rifabutin is preferred over rifampin in HIV patients on antiretroviral drugs such as protease inhibitors, as it does not interact with them.

▶ Tuberculosis in Pregnancy

All first-line drugs (INH, rifampin, pyrazinamide and ethambutol) except streptomycin can be used in pregnancy.

Chemoprophylaxis of Tuberculosis

It is the prophylactic use of antitubercular drugs to prevent the development of active tuberculosis in patients who are at risk. INH with rifampin is used for chemoprophylaxis as they are orally effective, less toxic and cheap.

Indications for chemoprophylaxis

1. Newborn of a mother with active tuberculosis.
2. Young children (<6 years) with positive tuberculin test.
3. Household contacts of patients with tuberculosis.
4. Patients with positive tuberculin test with additional risk factors such as diabetes mellitus, malignancy, silicosis, AIDS, etc.

Role of Glucocorticoids in Tuberculosis

Tuberculosis is a relative contraindication for the use of glucocorticoids. However, in certain situations, glucocorticoids may be used under the cover of effective antitubercular therapy for tuberculosis of serous membranes (pleura, pericardium, meninges, etc.), tuberculosis of the eye, larynx, genitourinary tract and to treat hypersensitivity reactions to antitubercular drugs.

Prednisolone is the preferred agent, except in meningitis (dexamethasone is preferred in this condition as it lacks mineralocorticoid activity).

Key Points for Dentists

- Rifampin and rifabutin may cause discolouration (orange red) of saliva, urine and other body secretions, which is harmless.
- Elective dental procedures in sputum-positive tubercular patients should be avoided till sputum becomes negative for acid-fast bacillus (AFB).

ANTILEPROTIC DRUGS

Leprosy is a chronic infectious disease caused by *Mycobacterium leprae*, which is an acid-fast bacillus.

Types of leprosy

Lepromatous leprosy: The cell-mediated immunity (CMI) is impaired against lepra bacilli, hence, the course of the disease progresses very rapidly. This is characterized by extensive bilateral skin lesions that contain numerous lepra bacilli.

Tuberculoid leprosy: The cell-mediated immunity is intact and is characterized by the predominant peripheral nerve involvement with a single or few skin lesions. The bacilli are seen rarely.

Plenty of lepra bacilli are seen in the skin lesions of borderline (BB), borderline lepromatous (BL) and lepromatous leprosy (LL), hence, these groups are called as **multibacillary leprosy** (MBL).

Borderline tuberculoid (BT), tuberculoid (TT) and indeterminate (I) leprosy are referred to as **paucibacillary leprosy**.

Drugs used for the treatment of leprosy

Dapsone (diaminodiphenylsulfone, DDS), clofazimine, rifampin, ethionamide, ofloxacin, minocycline and clarithromycin are the drugs used in leprosy.

■ Dapsone or Diaminodiphenylsulfone

Dapsone, a sulfone, is the oldest, cheapest and most widely used agent for the treatment of leprosy even today.

Mechanism of action

Sulfones are chemically related to sulphonamides and have the same mechanism of action. Lepra bacilli utilize *para*-aminobenzoic acid (PABA) for the synthesis of folic acid, which, in turn, is necessary for its growth and multiplication. Dapsone is structurally similar to PABA; hence, it competitively inhibits folate synthetase enzyme and prevents the formation of tetrahydrofolic acid (THFA). Thus dapsone produces leprostatic effect.

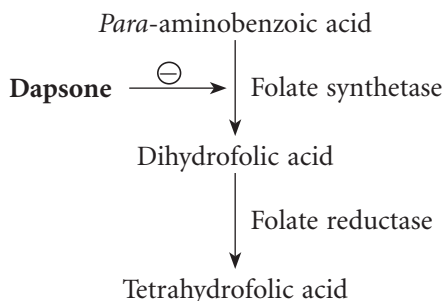

Pharmacokinetics

Dapsone is given orally and is almost completely absorbed from the gut; it is bound to plasma proteins, widely distributed in the body and concentrated mainly in the infected skin, muscle, liver, kidney, etc. It is partly secreted in bile and undergoes enterohepatic cycling. Dapsone is metabolized by acetylation and metabolites are excreted in urine.

Adverse effects

The common adverse effects are dose-related haemolytic anaemia particularly in patients with G6PD deficiency. Other side effects are anorexia, nausea, vomiting, fever, headache, allergic dermatitis, itching and peripheral neuropathy. Dapsone may cause exacerbation of lesions—‘sulfone syndrome’, which is characterized by fever, dermatitis, pruritus, lymphadenopathy, methaemoglobinaemia, anaemia and hepatitis.

■ Rifampin

It is the most effective and rapidly acting bactericidal drug for lepra bacilli; it kills most of the bacilli.

■ Clofazimine

It is a phenazine dye and has leprostatic activity against lepra bacilli. It has antiinflammatory effect, hence, is also useful in the treatment of type-2 lepra reaction. Clofazimine binds to mycobacterial DNA to inhibit its template function. It also has activity against dapsone-resistant organism. It is given orally—fatty meal increases its absorption. It accumulates in tissues— $t/2$ is 70 days. It causes reddish-black discolouration of the skin on exposed parts. It can cause pigmentation of the conjunctiva and cornea, discolouration of the hair, tears, sweat, urine, etc. Nausea, vomiting, diarrhoea, and abdominal pain are its other side effects.

Other drugs used are ethionamide, clarithromycin, minocycline and ofloxacin.

■ Chemotherapy of Leprosy

The WHO recommends the use of MDT for all leprosy cases. Clinically, leprosy has been classified into two types—multibacillary and paucibacillary leprosy. The objectives and need for MDT are:

1. To make the patient noncontagious as early as possible by killing the dividing bacilli.
2. To prevent the development of drug-resistant bacilli.
3. To prevent relapse.
4. To shorten the duration of effective therapy.

■ Treatment Schedules of Leprosy

All drugs are administered orally.

1. For multibacillary leprosy (LL, BL and BB)

- Rifampin 600 mg once monthly +
- Clofazimine 300 mg once monthly } Supervised
- +
- Dapsone 100 mg daily +
- Clofazimine 50 mg daily } Unsupervised (self-administered)

The duration of treatment is 1 year, and later the patient should be followed up for a period of 3–5 years. If clofazimine is unacceptable, the alternative drug used is ethionamide 250 mg daily, unsupervised.

2. For paucibacillary leprosy (TT, BT and I)

- Rifampin 600 mg once monthly (supervised) +
- Dapsone 100 mg daily (unsupervised).

The duration of treatment is 6 months, and later the patient should be followed up for a period of 1–2 years.

■ Lepra Reaction

These are immunologically mediated reactions that occur during the course of the disease. The exact cause of such reactions is not clear and is usually precipitated by infection, trauma, mental stress, etc. There are two types of reactions:

1. **Type-1 lepra reaction (reversal reaction):** It is a delayed type of hypersensitivity and is seen in tuberculoid leprosy. There are signs of inflammation in the existing skin lesions—they become red, warm and swollen. New lesions may appear. Nerves are frequently affected; when they occur after the initiation of therapy, they are known as reversal reactions. It is treated with clofazimine or prednisolone.
2. **Type-2 lepra reaction [erythema nodosum leprosum (ENL)]:** It occurs in lepromatous leprosy. It is a type-III hypersensitivity reaction (Arthus-type). There is erythema nodosum—red, painful, tender cutaneous and subcutaneous nodules. Nerves may be affected. Constitutional symptoms are present. The type-2 reaction may be due to release of antigen from the dying lepra bacilli. Severe form of type-2 reaction is treated with thalidomide, but it should not be prescribed during pregnancy. The other drugs used are aspirin, clofazimine, chloroquine and prednisolone.

ANTIFUNGAL AGENTS

Most of the fungal infections (Table 11.15) are opportunistic; hence, they are common in diabetes mellitus, cancer, AIDS, pregnancy and in patients on immunosuppressive therapy such as prolonged course of corticosteroids, broad-spectrum antibiotics, anticancer drugs, etc.

Table 11.15 Fungal Infections/Causative Organisms

Superficial mycosis	Deep mycosis
1. Dermatophytes	1. Aspergillus
a. Epidermophyton	2. Blastomyces
b. Trichophyton	3. Cryptococcus
c. Microsporum	4. Coccidioides
2. Candida	5. Candida
3. Malassezia furfur	6. Histoplasma
	7. Mucormycosis
	8. Sporotrichosis

Classification

1. **Antifungal antibiotics:** Amphotericin B, nystatin, hamycin and griseofulvin.
2. **Antimetabolites:** Flucytosine.
3. **Azoles:**
 - a. *Imidazoles:* Ketoconazole, miconazole, clotrimazole.
 - b. *Triazoles:* Fluconazole, itraconazole, voriconazole.
4. **Allylamine:** Terbinafine.
5. **Echinocandins:** Caspofungin acetate, micafungin.
6. **Other topical agents:** Whitfield's ointment, tolnaftate, sodium thiosulphate and selenium sulphide.

Polyene antibiotics: Amphotericin B, nystatin and hamycin are polyene antibiotics and have the same mechanism of action.

■ Amphotericin B (Table 11.16)

Amphotericin B (AMB) is a broad-spectrum antifungal antibiotic. It is effective against *Cryptococcus*, *Coccidioides*, *Candida*, *Aspergillus*, *Blastomyces*, *Histoplasma*, *Sporothrix*, fungi causing mucormycosis, etc.

Mechanism of action

Fungal cell membrane contains a sterol, which resembles cholesterol and is called 'ergosterol'.

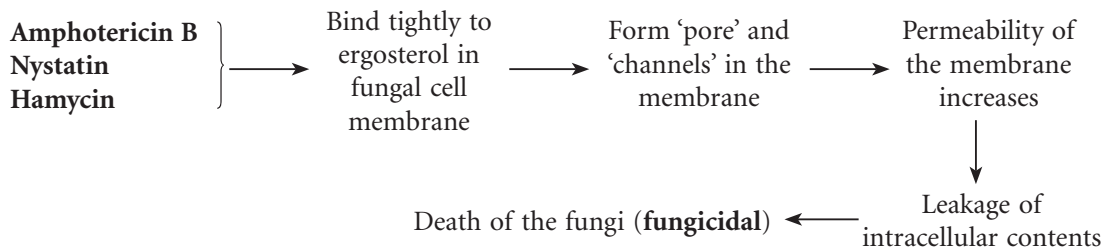

Pharmacokinetics

Amphotericin B is not absorbed from the gut and hence is not suitable orally for systemic infections. It is highly bound to plasma proteins and sterols in tissues, widely distributed to various tissues but does not cross the BBB. It is metabolized in liver and excreted slowly in urine and bile.

Adverse effects

- AMB is the most toxic of all the antifungal agents. The acute reactions are fever, chills, headache, dyspnoea, phlebitis at the site of injection, nausea and vomiting, etc.
- Anaemia and electrolyte disturbances are commonly seen. Anaemia is less with lipid formulations.
- Nephrotoxicity with azotaemia is seen in most of the patients on AMB therapy.
- Hepatotoxicity can occur occasionally.
- Headache and convulsions may occur on intrathecal administration.

Formulations of amphotericin B

Amphotericin B is poorly water soluble; hence, intravenous preparation is made with deoxycholate—conventional amphotericin B (C-AMB).

ABCD (AMB colloidal dispersion), ABLC (AMB–lipid complex) and liposomal AMB (L-AMB) are the lipid-based new formulations of AMB. They are less nephrotoxic than C-AMB.

Uses

Amphotericin B is highly efficacious but highly toxic too; hence, the azoles (fluconazole and itraconazole) have replaced AMB in the treatment of many fungal diseases. AMB is useful for various systemic fungal infections like aspergillosis, cryptococcosis, sporotrichosis, candidiasis, cryptococcal meningitis, etc.

■ Nystatin

Nystatin is poorly absorbed from the skin and mucous membranes. It is highly toxic for systemic use. It is used only topically in *Candida* infections. It is available as suspension, ointment, cream, powder and tablet.

Uses

1. In dentistry: Nystatin is used topically for oral candidiasis, angular cheilitis and antibiotic-associated stomatitis. Nystatin oral suspension 5 mL (1 lakh units/mL) to be swished and swallowed 4–5 times a day for 14 days.
2. Other uses include oropharyngeal, corneal, conjunctival and cutaneous candidiasis.

Adverse effects

They include nausea and bitter taste.

■ Hamycin

It was developed in India (Hindustan Antibiotics). It is useful topically for oral, cutaneous and vaginal candidiasis.

■ Griseofulvin

Griseofulvin is used orally for dermatophytic infections. It is not effective topically.

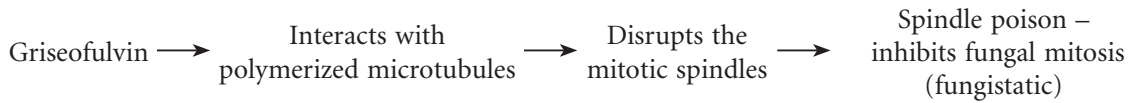
Mechanism of action**Pharmacokinetics**

Griseofulvin is administered orally. Its bioavailability is increased by taking with fatty food and by using ultrafine preparation. It gets concentrated in keratinized tissues such as skin, hair, nails, etc. It is an enzyme inducer; thus, it reduces the effectiveness of warfarin and oral contraceptives. It has disulfiram-like action, hence can cause intolerance to alcohol. It is metabolized in liver and excreted in urine.

Uses

Griseofulvin is used in the treatment of dermatophytic infections like tinea (ringworm) infections (*Tinea capitis*, *Tinea barbae*, *Tinea corporis*, *Tinea pedis*).

Adverse effects

They are headache, rashes, peripheral neuritis, vertigo, blurred vision and GI effects such as nausea, vomiting, diarrhoea, heartburn, etc.

■ Flucytosine (Table 11.16)

Flucytosine is a prodrug. It is taken up by susceptible fungal cells and converted into 5-fluorouracil (5-FU) that interferes with fungal DNA synthesis. Flucytosine has narrow spectrum of activity and is effective against *Cryptococcus*, *Chromoblastomyces* and *Candida* spp.

Table 11.16 Differences Between Amphotericin B and Flucytosine

Amphotericin B	Flucytosine
Active drug	Prodrug
Has broad spectrum of activity	Has narrow spectrum of activity
Antifungal antibiotic	Antimetabolite
Fungicidal	Fungistatic
Not absorbed through GI tract	Well absorbed from GI tract
Highly bound to plasma proteins and sterols in tissues	Poorly bound to plasma proteins
Does not cross BBB	Freely crosses BBB and reaches high concentration in CSF
Metabolized in liver and excreted slowly in urine and bile	Excreted in urine mainly in unchanged form
Highly efficacious and highly toxic drug	Less effective and less toxic than AMB
Given intravenously, intrathecally and topically	Given orally

Uses

Flucytosine is used in combination with AMB for cryptococcal meningitis. The advantages of this combination are:

1. The entry of flucytosine into the fungal cells is facilitated because of the increased permeability of the membrane due to the action of AMB.

2. Reduced toxicity of AMB because of reduction in the drug dosage.
3. Less chance for emergence of resistance.

Adverse effects

These include bone marrow suppression with anaemia, neutropaenia and thrombocytopenia. The other side effects include nausea, vomiting, diarrhoea, alopecia, skin rashes, itching and rarely hepatitis.

Azoles

Azole antifungals are broadly divided into imidazoles and triazoles. Both of them are structurally related compounds, have similar mechanism of action and antifungal spectrum (Fig. 11.11).

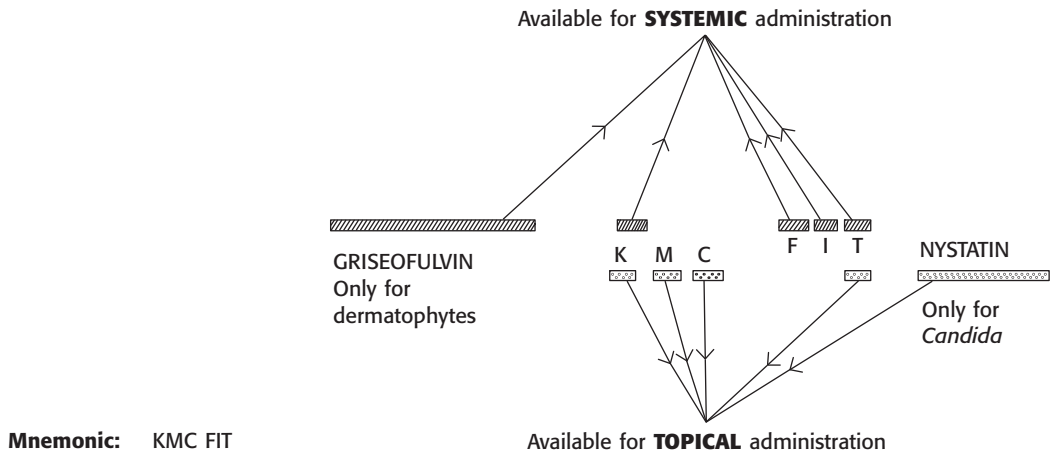

Fig. 11.11 Route of administration and spectrum of various antifungal agents. K, ketoconazole; M, miconazole; C, clotrimazole; F, fluconazole; I, itraconazole; T, terbinafine. *KMC FI*: Have a wide spectrum of activity; Terbinafine: for dermatophytes and *Candida*.

Mechanism of action

Azoles impair ergosterol synthesis by inhibiting 14α -demethylase enzyme (Fig. 11.12).

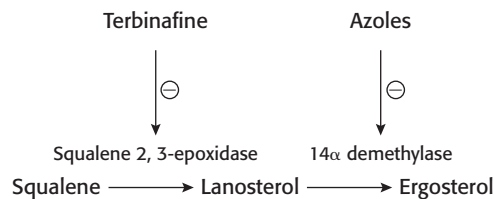

Fig. 11.12 Mechanism of action of azoles and terbinafine.

Miconazole and Clotrimazole

They are used topically for dermatophytic and *Candida* infections. They are available as cream, gel, lotion, solution, spray, vaginal pessary, etc. Clotrimazole troche is also available.

Uses

1. **Candida infections:** Clotrimazole is frequently used for the treatment of oropharyngeal candidiasis—it can be used as gel, lotion or troche (troche 10 mg to be allowed to dissolve in the mouth QID for 14 days).
Clotrimazole and miconazole are used for the treatment of vulvovaginal and cutaneous candidiasis. Miconazole is also useful in otomycosis.
2. **Dermatophytic infections:** Clotrimazole and miconazole are useful for *Tinea pedis*, *Tinea cruris*, *Tinea corporis* and *Tinea versicolor*.

Adverse effects

These are local irritation, itching or burning. Miconazole is safe for use during pregnancy.

▶ Ketoconazole

Ketoconazole (KTZ) is a prototype drug among azoles.

Pharmacokinetics

It is orally effective. Acidic environment favours the absorption of KTZ; hence, its bioavailability is reduced by drugs like H₂-blockers, proton pump inhibitors or antacids. It is highly bound to plasma proteins, metabolized in liver extensively and excreted mainly in faeces.

Adverse effects

Ketoconazole is the most toxic among azoles, but it is less toxic than amphotericin B. Anorexia, nausea and vomiting are the most common side effects. It reduces adrenal cortical steroids, testosterone and oestrogen synthesis—thus causes gynaecomastia, oligospermia, loss of libido and impotence in males; menstrual irregularities and amenorrhoea in females.

Drug interactions

Ketoconazole inhibits the metabolism of sulfonylureas, warfarin, phenytoin, terfenadine, etc.

Uses

1. **Dermatophytosis:** Ketoconazole is used topically.
2. **Candidiasis:** KTZ is useful for oral, oesophageal and vulvovaginal candidiasis. It is very toxic for systemic use; hence it has been replaced by triazoles.

▶ Fluconazole

It is a triazole. It is available for oral and i.v. administration as well as for topical use in the eye. It has broad spectrum of antifungal activity (Table 11.17).

Pharmacokinetics

It is well absorbed from the GI tract and has a high bioavailability. Food or gastric pH does not affect its bioavailability. It is poorly bound to plasma proteins, widely distributed in the body, freely crosses the BBB and reaches high concentration in the CSF. It is mainly excreted in urine in the unchanged form.

Table 11.17 Antifungal Agents and their Uses

AMB	Flucytosine	KTZ	Fluconazole	Itraconazole	Voriconazole	Nystatin Hamycin (Topical)	Griseofulvin (Oral)	Terbinafine	Caspofungin Acetate
Aspergillosis Blastomycosis Candidiasis Cryptococcosis Coccidioidomycosis Histoplasmosis Mucormycosis Sporotrichosis	Cryptococcosis Candidiasis (some species) Chromoblastomycosis	Candidiasis Dermatophytosis	Cryptococcosis Candidiasis Coccidioidomycosis	Candidiasis Dermatophytosis Blastomycosis Histoplasmosis Coccidioidomycosis Aspergillosis Sporotrichosis	Aspergillosis Candidiasis	Candidiasis only	Dermatophytosis only	Dermatophytosis Candidiasis	Candidiasis Aspergillosis

AMB, Amphotericin B; KTZ, Ketoconazole.

Adverse effects

The common side effects are nausea, vomiting, diarrhoea and abdominal discomfort. The other side effects include headache, alopecia, skin rashes and hepatic necrosis. It is contraindicated during pregnancy because of teratogenic effect. Fluconazole has enzyme inhibiting property.

Uses

1. **Candidiasis:** Fluconazole is effective in oral (200 mg stat, then 100 mg daily for next 14 days), oropharyngeal, oesophageal, cutaneous and invasive candidiasis.
2. **Cryptococcal and coccidioidal meningitis:** Intravenous fluconazole is used.

Itraconazole

It is a synthetic triazole. It is administered orally as well as by i.v. route. Gastric acidity favours the absorption of itraconazole. It is highly bound to plasma proteins, does not cross BBB and is metabolized in liver. It has a broad spectrum of activity against many fungi including *Aspergillus*.

Adverse effects

These are nausea, vomiting, diarrhoea, headache, hepatotoxicity and hypokalaemia. Itraconazole inhibits CYP3A4 and can increase serum levels of drugs metabolised by this enzyme.

Uses

Itraconazole is an effective antifungal agent but rarely used in dental practice.

1. It is effective for oesophageal, oropharyngeal and vaginal candidiasis, but not superior to fluconazole.
2. Intravenous itraconazole is the drug of choice in systemic fungal infections like histoplasmosis, blastomycosis and sporotrichosis.
3. In onychomycosis, oral itraconazole is used.
4. It is also effective in aspergillosis and dermatophytosis.

Voriconazole

It is a triazole. It is used for the treatment of invasive aspergillosis and disseminated *Candida* infections. Voriconazole is administered orally or intravenously. Adverse effects include visual and auditory disturbances, prolongation of QT interval, and skin rashes.

Allylamine**Terbinafine**

Terbinafine, an allylamine, inhibits squalene 2,3-epoxidase and blocks ergosterol synthesis (Fig. 11.11). It is available for topical as well as for oral administration. It is well absorbed after oral administration and is concentrated in skin, nails and adipose tissue. It is highly bound to plasma proteins, poorly penetrates the BBB, metabolized in liver and is excreted in urine. Terbinafine is a fungicidal agent.

Adverse effects

Terbinafine may cause side effects such as nausea, diarrhoea, dyspepsia and rarely hepatitis. It may cause itching, rashes, local irritation on topical use.

Uses

1. **Dermatophytosis:** Terbinafine is very effective against dermatophytes. It is used topically or orally for *T. pedis*, *T. corporis* and *T. cruris*.
In onychomycosis of hands and feet, it is used orally and is more effective than itraconazole.
2. **Candidiasis:** Terbinafine is less effective in *Candida* infections.

Echinocandins

Caspofungin Acetate

Caspofungin Acetate is a semisynthetic antifungal agent effective against *Candida* and *Aspergillus*. It is administered by i.v. infusion for the treatment of invasive aspergillosis and candidiasis, when the patient is not responding to or intolerant to other antifungal agents. The adverse effects include nausea, vomiting, flushing, fever and phlebitis at the site of injection.

Other Topical Agents

1. **Whitfield's ointment:** It contains 6% benzoic acid and 3% salicylic acid. Salicylic acid has keratolytic and benzoic acid has fungistatic effects. It is used in the treatment of *T. pedis*.
2. **Selenium sulphide:** It is useful for *T. versicolor*.
3. **Sodium thiosulphate:** It has fungistatic effect and is useful in *T. versicolor*.
4. **Potassium iodide:** It is useful for dermatophytic infection.
5. **Butenafine:** Its mechanism of action and spectrum of activity is similar to terbinafine.

Key Points for Dentists

- Clotrimazole, nystatin and fluconazole are the commonly used antifungal drugs for oral candidiasis.
- Proper instructions should be given to the patient regarding the topical application of antifungal agents in oral candidiasis.

ANTIVIRAL AGENTS

Classification

1. **Drugs used against herpetic infection (antiherpes agents):** Acyclovir, valacyclovir, famciclovir, penciclovir, ganciclovir, foscarnet, idoxuridine.
2. **Drugs used against HIV infection (antiretroviral agents)**
 - a. **Nucleoside reverse transcriptase inhibitors:** Zidovudine, stavudine, lamivudine, didanosine, zalcitabine, abacavir, emtricitabine, tenofovir.
 - b. **Non-nucleoside reverse transcriptase inhibitors:** Nevirapine, efavirenz, delavirdine.
 - c. **Protease inhibitors:** Saquinavir, indinavir, ritonavir, lopinavir, nelfinavir, amprenavir.
 - d. **Entry inhibitors:** Enfuvirtide, maraviroc.
 - e. **Integrase inhibitor:** Raltegravir.
3. **Anti-influenza agents:** Amantadine, rimantadine, oseltamivir, zanamivir.
4. **Other antiviral agents:** Interferons and ribavirin.

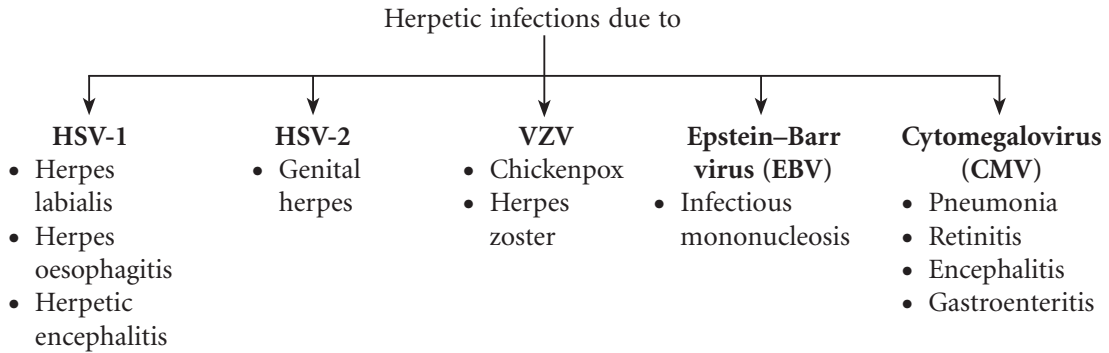

■ Antiherpes Agents

▶ Acyclovir

It is a synthetic, purine nucleoside analogue that has antiherpes activity. It is more effective against HSV-1 and HSV-2 than *Varicella zoster* virus (VZV) infections.

Mechanism of action

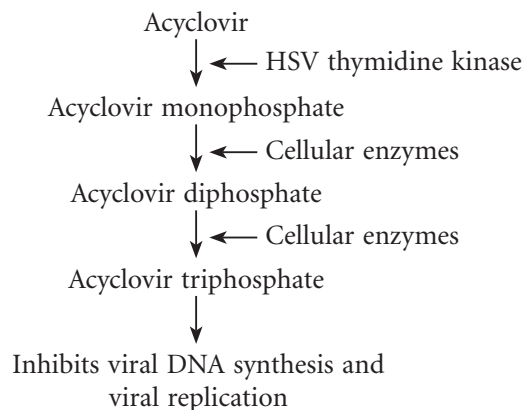

Acyclovir is selectively taken up by the herpes virus infected cells and activated to triphosphate derivative, which inhibits viral DNA synthesis. It is available for oral, topical and i.v. administration. It is a highly potent antiherpes drug. It has high therapeutic index with low toxicity to host cells.

Its oral bioavailability is poor. It is poorly bound to plasma proteins, widely distributed in the body, freely crosses BBB and is excreted in urine.

Uses

1. **Mucocutaneous HSV:** Acyclovir is used orally or topically in the treatment of gingivostomatitis, herpes labialis and ulcers in mouth (200–800 mg orally five times daily). It is used intravenously in immunocompromised patients.
2. **Other uses** are genital herpes, herpetic encephalitis, herpes simplex keratitis, chickenpox and herpes zoster.

Adverse effects

Acyclovir is usually well tolerated. Nausea, vomiting, diarrhoea and headache are the other side effects. High doses may cause neurotoxicity with tremor, confusion, disorientation and convulsions. On topical use, it can cause irritation and burning.

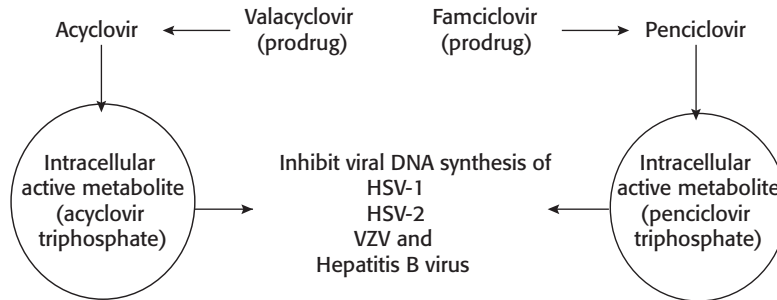

Valacyclovir

Valacyclovir is a prodrug of acyclovir. Valacyclovir is converted to acyclovir in liver after oral administration. It produces greater oral bioavailability than acyclovir.

Famciclovir

Famciclovir is a prodrug of penciclovir. Famciclovir is administered orally, well absorbed and converted to penciclovir in liver. The mechanism of action of valacyclovir and famciclovir are similar to acyclovir. Famciclovir has activity against hepatitis-B virus.

Penciclovir

Penciclovir is administered through topical and i.v. routes. It is used in the treatment of genital herpes and herpes zoster infections.

Ganciclovir

The structure and mechanism of action of ganciclovir is similar to acyclovir. Ganciclovir is reserved for the treatment and prophylaxis of severe CMV infections—retinitis, pneumonia, gastroenteritis, etc. in immunocompromised individuals.

Anti-influenza Agents

Amantadine

It is an antiviral drug that has antiparkinsonian effect as well. It inhibits viral replication. Amantadine is used orally for the prophylaxis and treatment of influenza-A virus infection.

Oseltamivir

It selectively inhibits influenza A and B virus neuraminidases, thus interfering with the release of virus from infected cells. It is used orally in the treatment and prevention of influenza A (avian influenza or bird flu) and B virus infections. Adverse effects are nausea, vomiting and abdominal discomfort.

Zanamivir

The mechanism of action and uses are similar to oseltamivir. Oral bioavailability is low. It is administered by inhalation. Adverse effects are bronchospasm, headache and dizziness. It should be avoided in patients with airway disease.

ANTIRETROVIRAL AGENTS

- Nucleoside reverse transcriptase inhibitors, protease inhibitors and integrase inhibitors are effective against both HIV-1 and HIV-2.
- Non-nucleoside reverse transcriptase inhibitors and entry inhibitors are active against HIV-1.

Nucleoside Reverse Transcriptase Inhibitors (NRTIs)

These drugs, after entering the HIV-infected cells, are converted to their active triphosphate forms by cellular kinases and competitively inhibit HIV reverse transcriptase. They get incorporated into the growing viral DNA and cause termination of chain elongation of proviral DNA (Fig. 11.13).

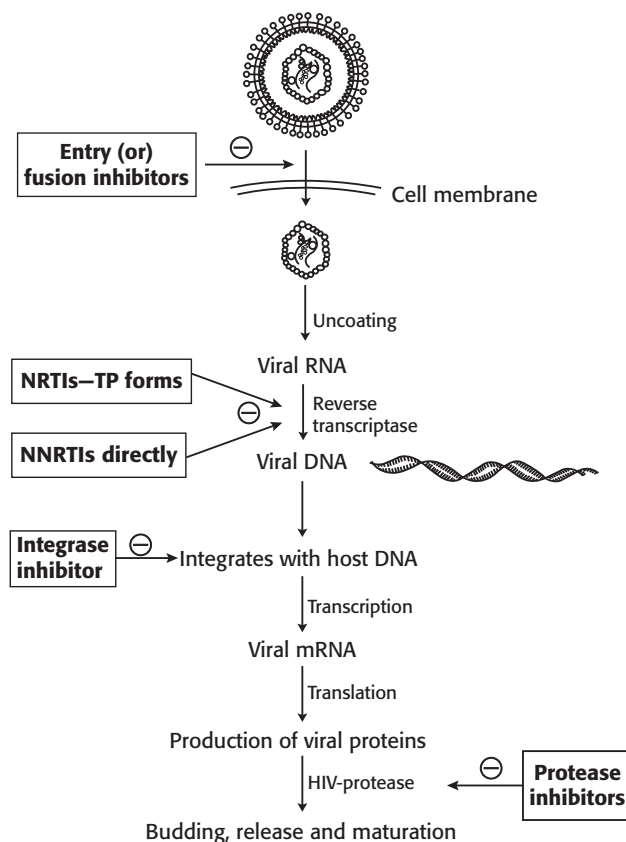

Fig. 11.13 Steps in the life cycle of HIV with sites of action of antiretroviral drugs. TP, triphosphate.

▀ Zidovudine [Azidothymidine (AZT)]

Zidovudine was the first antiretroviral drug approved for the treatment of HIV infection. It is the prototype drug of NRTIs. Zidovudine is effective against HIV-1 and HIV-2. It protects the uninfected cells from HIV, but has no effect on HIV-infected cells. Zidovudine is orally effective. It is well absorbed from GI tract, metabolized in liver by glucuronide conjugation and excreted in urine. It crosses placenta and BBB, and is also secreted in milk.

Adverse reactions

Bone marrow suppression, anaemia and neutropaenia are the common side effects. Nausea, vomiting, abdominal discomfort, headache and insomnia are commonly seen during the initial stages of therapy. Long-term therapy may cause hepatotoxicity, myopathy with fatigue and lactic acidosis.

1. **Zidovudine × paracetamol:** Both are metabolized by glucuronide conjugation. Paracetamol competes and interferes with glucuronide conjugation of zidovudine. This leads to a rise in the plasma concentration of zidovudine and its toxicity.
2. **Azoles × zidovudine:** Azole antifungal agents are hepatic microsomal enzyme inhibitors. They inhibit the metabolism of zidovudine and increase its blood level resulting in its toxicity.
3. **Zidovudine and stavudine:** They should not be combined together because they compete for intracellular phosphorylation.

Zidovudine is used in combination with other antiretroviral drugs for the treatment of AIDS. It is also used for post-exposure prophylaxis (PEP) and to prevent vertical transmission of HIV.

▀ Didanosine, Stavudine, Emtricitabine and Lamivudine

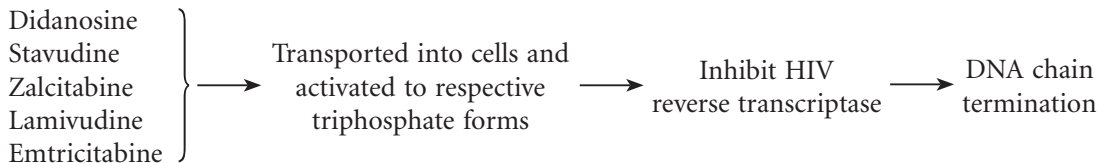

They are effective orally. The adverse effects are peripheral neuritis, pancreatitis, gastrointestinal disturbances, lactic acidosis, skin rashes, etc. Lamivudine is a commonly used agent in antiretroviral therapy because of its efficacy and low toxicity.

■ Non-nucleoside Reverse Transcriptase Inhibitors (NNRTIs)

NNRTIs are highly active against HIV-1 but have no effect on HIV-2. There is no cross-resistance with the NRTIs. They are used in combination with NRTIs in the treatment of AIDS.

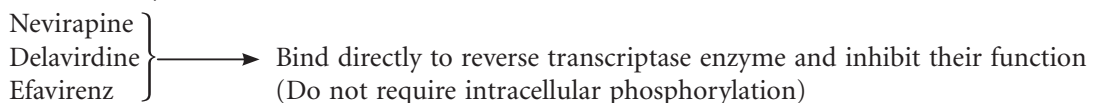

Adverse effects are skin rashes, fever, nausea, pruritus and CNS disturbances like headache, confusion, insomnia, bad dreams, amnesia, etc.

■ Protease Inhibitors (PIs)

They competitively inhibit the HIV protease enzyme → prevent cleavage of viral polyproteins to the final functional, structural and enzymatic components of HIV → immature and noninfectious viral particles are produced.

Cross-resistance is common among the PIs, but there is no cross-resistance with reverse transcriptase inhibitors. PIs are used orally with reverse transcriptase inhibitors in patients with AIDS. PIs are extensively metabolized in liver. Nausea, vomiting and diarrhoea are common side effects. They also produce skeletal muscle wasting, lipodystrophy, insulin resistance, diabetes, etc.

■ Other Drugs

● Entry or Fusion Inhibitors: Enfuvirtide and Maraviroc

Enfuvirtide and maraviroc prevent viral entry into the cell. They are used as add on drugs in patients who are not responding to ongoing antiretroviral therapy (ART).

■ Treatment of HIV Infection

Retroviruses contain RNA-dependent DNA polymerase (reverse transcriptase) enzyme. They cause selective depletion of CD4 cells leading to a profound decrease in cell-mediated immunity. Hence, the infected person is prone to severe opportunistic infections and lymphoid malignancies.

Objectives of anti-HIV therapy

1. To suppress HIV replication and improve immune status of the patient.
2. To prevent the emergence of drug-resistant virus.
3. To prevent or treat opportunistic infections.

Principles of therapy

Antiretroviral therapy (ART) regimen is used to achieve the above objectives. In ART regimen, drugs with different mechanism of action should be used so that they produce synergistic effect. It usually consists of a combination of two NRTIs with an NNRTI or a PI (two NRTIs + one NNRTI, two NRTIs + one PI).

Criteria for anti-HIV treatment

ART is initiated for all HIV patients with CD4 count of ≤ 350 cells/mm³ and for those with WHO clinical stage 3 or 4 if CD4 testing is not available.

Initial ART: 1 NNRTI (NVP/EFV) + 2 NRTIs (one should be 3 TC/FTC, other one AZT/TDF).

- Emtricitabine (FTC): 200 mg OD
- Lamivudine (3TC): 150 mg BD/300 mg OD
- Zidovudine (AZT): 250–300 mg BD
- Tenofovir ((TDF): 300 mg OD
- Efavirenz (EFV): 600 mg OD
- Nevirapine (NVP): 200 mg OD

Regimens

For HIV-positive patients who have not received prior ART (HIV positive ARV naïve adults and adolescents).

- Zidovudine + Lamivudine + Efavirenz or

- Zidovudine + Lamivudine + Nevirapine or
- Tenofovir + Lamivudine + Efavirenz/Nevirapine

Monitoring of therapy

By estimating the level of HIV-RNA load and CD4 count.

Prophylaxis of HIV infection (postexposure prophylaxis)

Doctors, nurses, technicians and other healthcare workers who have had accidental exposure to HIV infection with surgical instruments, blood transfusion or needle-prick injury require prophylactic therapy. The need for postexposure prophylaxis (PEP) depends on the degree of exposure to HIV and the HIV status of the exposure source.

Depending on risk of HIV, either a basic regimen or an expanded regimen can be used (National AIDS Control Organization, NACO, India).

- *Basic regimen*
Zidovudine 300 mg + Lamivudine 150 mg, each BD for 4 weeks
- *Expanded regimen*
Zidovudine 300 mg + Lamivudine 150 mg, each BD } for 4 weeks
+ Indinavir 800 mg TDS

In HIV-positive pregnant women, zidovudine therapy is required to prevent vertical transmission to the offspring, and it should be continued in the newborn for 6 weeks.

Key Points for Dentists

- Accidental exposure to HIV infection (needle prick, blood transfusion, etc.) requires prophylactic antiretroviral therapy.
- Patient on ART should consult a physician before taking other drugs because of the possibility of drug interactions.
- Multidrug therapy should always be used in HIV infections.

ANTIMALARIAL DRUGS

Malaria is a protozoal infection caused by genus *Plasmodium* and transmitted to man by the infected female *Anopheles* mosquito. The species of malarial parasites are *Plasmodium vivax*, *Plasmodium ovale*, *Plasmodium malariae* and *Plasmodium falciparum*. The incidence of malaria is increasing due to the resistance of vectors to insecticides and drug-resistant parasites. In India, *P. vivax* and *P. falciparum* are common.

Classification

Chemical classification

- 4-Aminoquinoline*: Chloroquine
- 8-Aminoquinoline*: Primaquine
- Quinoline methanol*: Mefloquine
- Alkaloids*: Quinine, quinidine
- Antifolates*: Pyrimethamine, sulphadoxine
- Antibiotics*: Doxycycline
- Qinghaosu compounds*: Artemisinin, artemether, artesunate.

■ 4-Aminoquinoline

► Chloroquine

Chloroquine is a 4-aminoquinoline. It is very effective against *P. vivax*, *P. ovale*, *P. malariae* and chloroquine-sensitive strains of *P. falciparum*.

Mechanism of action

Chloroquine is a basic drug, which is taken up by the acidic food vacuoles of susceptible plasmodia and inhibits the conversion of heme to hemozoin. The 'drug-heme' complex is toxic and kills the parasite. Resistance to chloroquine is common with *P. falciparum*.

In the acidic vacuole of Plasmodia:

- Haemoglobin \longrightarrow Heme (toxic) \longrightarrow Hemozoin (non-toxic)
- Chloroquine (weak base) \longrightarrow Concentrated in acidic vacuole of parasite \longrightarrow binds to heme



Damages plasmodial membrane \leftarrow Drug – heme complex

Pharmacokinetics

Chloroquine is commonly administered by oral route, but it can also be given by i.m. and slow i.v. routes. It is well absorbed after oral and parenteral administration. It has strong affinity for melanin-containing tissues. It gets concentrated in liver, spleen, kidney, lungs, skin, etc. Chloroquine is metabolized in the liver and slowly excreted in urine.

Adverse effects and contraindications

Chloroquine in antimalarial doses may cause nausea, vomiting, skin rashes, itching, headache and visual disturbances. Parenteral administration can cause hypotension, confusion, cardiac arrhythmias, convulsions and even cardiac arrest. It can also cause ototoxicity, retinopathy, myopathy, neuropathy and rarely psychiatric disturbances. Long-term therapy requires ophthalmological examination. It is safe in pregnancy.

Uses

1. Malaria
 - a. Chloroquine is the drug of choice for the treatment of **acute attack** of malaria caused by *P. vivax*, *P. ovale*, *P. malariae* and chloroquine-sensitive *P. falciparum* (Table 11.18).
 - b. It is a very effective **chemoprophylactic** agent for all types of malaria except that caused by chloroquine-resistant strains of *P. falciparum* (mefloquine or doxycycline can be used).
2. Other uses are as follows:
 - a. Amoebiasis—hepatic.
 - b. Lepra reaction.
 - c. Rheumatoid Arthritis.
 - d. Infectious mononucleosis.
 - e. Autoimmune disorder—discoid lupus erythematosus.

Note: Uses of chloroquine: Mnemonic - **MALARIA**

Table 11.18 Regimens for Treatment of Malaria**Treatment of uncomplicated malaria**

- a. For acute attack of *P. vivax*, *P. ovale*, *P. malariae* and chloroquine-sensitive *P. falciparum*:
Oral chloroquine is the drug of choice.

Chloroquine	600-mg base (10 mg/kg) stat, followed by 300-mg base 6 h later	—First day
	300-mg base	—Second day
	300-mg base	—Third day

- b. For chloroquine-resistant *P. falciparum* infection:
Artemisinin-based combination therapy (ACT) is used.

Key Point for Dentists

↳ Patient should report to doctor if there is hearing loss or vision disturbances when on chloroquine.

NITROIMIDAZOLES

Nitroimidazoles are metronidazole, tinidazole, secnidazole, ornidazole, satranidazole, etc.

Metronidazole

Metronidazole is a nitroimidazole derivative, which is highly effective against most anaerobic bacteria and several protozoa such as *E. histolytica*, *Giardia lamblia* and *Trichomonas vaginalis*. It helps in the extraction of guinea worm (*Dracunculus medinensis*)

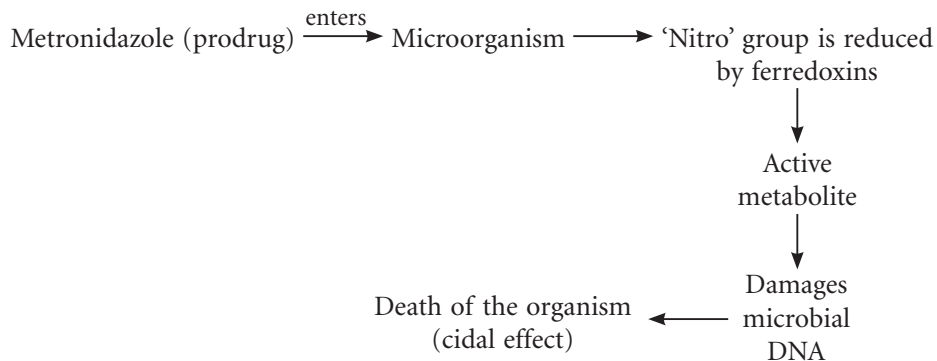
Mechanism of action

In the presence of oxygen (aerobes), metronidazole cannot be reduced to its active metabolite; hence it is ineffective against aerobes.

Pharmacokinetics

Metronidazole is available for oral, i.v. and topical administration. It is usually well absorbed after oral administration and poorly bound to plasma proteins. It diffuses well into the tissues including

brain; therapeutic levels are achieved in various body fluids—saliva, semen, vaginal secretion, bile, breast milk and CSF. Metronidazole is metabolized in the liver and the metabolites are excreted mainly in urine.

Adverse effects

Adverse effects are rarely severe to necessitate the discontinuation of the drug.

1. **Gastrointestinal:** Anorexia, nausea, metallic taste, dry mouth, epigastric distress, abdominal cramps and occasionally vomiting.
2. **Allergic reactions:** These include skin rashes, urticaria, itching and flushing.
3. **CNS:** Dizziness, vertigo, confusion, irritability, headache, rarely convulsions and ataxia may occur. Polyneuropathy may occur on prolonged therapy.
4. **Disulfiram-like reaction** (nausea, vomiting, abdominal cramps, headache, flushing, etc.) may occur if taken with alcohol; hence, patient should be warned to avoid alcohol during treatment with metronidazole.

Teratogenic effect is seen in experimental animals; hence metronidazole should be avoided in pregnant women.

Drug interactions

1. Metronidazole potentiates the anticoagulant effect of warfarin and other oral coumarins by inhibiting their metabolism. There is prolongation of prothrombin time; hence, reduction of warfarin dose may be needed.
2. Metronidazole may potentiate lithium toxicity by decreasing the renal clearance of lithium.

Uses

1. **Anaerobic infections:** Metronidazole is highly effective in most of the anaerobic infections caused by *Bacteroides spp.*, *Borrelia vincenti*, *Fusobacterium*, *Peptostreptococcus*, *Clostridium* and other anaerobic organisms.
 - a. Vincent's angina (acute ulcerative gingivitis): It is an anaerobic infection associated with *Borrelia vincenti* and *Fusobacterium*. Metronidazole (200–400 mg three times daily for 7 days) is highly effective in Vincent's angina as it is secreted in the saliva. It is often used with penicillins (amoxicillin 500 mg TDS for 7 days).
 - b. Metronidazole is used in the treatment of alveolar abscess, pericoronitis, periodontitis, etc. It is often used in combination with penicillins (penicillin V or amoxicillin).
 - c. In antibiotic-associated pseudomembranous colitis, metronidazole is effective. It is cheaper and less toxic than vancomycin.
 - d. In anaerobic brain abscess, metronidazole is often used in combination with a third-generation cephalosporin.
 - e. In the treatment of *H. pylori* infection, metronidazole is useful in combination with clarithromycin or amoxicillin and a proton pump inhibitor.
2. **Amoebiasis:** Metronidazole (400–800 mg TDS for 7–10 days) is the drug of choice for the treatment of all forms of amoebiasis. Thus, it is useful in the treatment of both intestinal and extraintestinal amoebiasis.
3. **Other uses** are trichomonas vaginitis, giardiasis, etc.

Tinidazole

Most of the features are similar to metronidazole. Tinidazole has a longer duration of action and better tolerability than metronidazole.

Uses

1. **Orodonal infections:** Tinidazole 600 mg twice a day for 5 days or 2 g once daily orally for 3 days is used for anaerobic infections of oral cavity.
2. **Amoebiasis:** 2 g once daily orally for 3 days or 600 mg twice daily for a week.

Secnidazole

Like metronidazole, secnidazole is a nitroimidazole derivative. The spectrum, side effects and mechanism of action of secnidazole are similar to metronidazole.

Ornidazole and Satranidazole

Both of these are nitroimidazoles with longer duration of action and better tolerability than metronidazole. Satranidazole does not have interaction with alcohol (disulfiram-like reaction).

Key Points for Dentists

- Patients should be advised to avoid alcohol during metronidazole therapy.
- To minimize nausea, metronidazole should be taken after food.

ANTICANCER DRUGS

Cancer is a disease of cells characterized by **Progressive, Persistent, Perverted** (abnormal), **Purposeless** and uncontrolled **Proliferation** of tissues.

Both normal as well as cancerous cells must pass through the following phases of cell cycle (Fig. 11.14).

1. **G₁ phase (presynthetic phase):** Synthesis of enzymes and other cellular components needed for DNA synthesis.

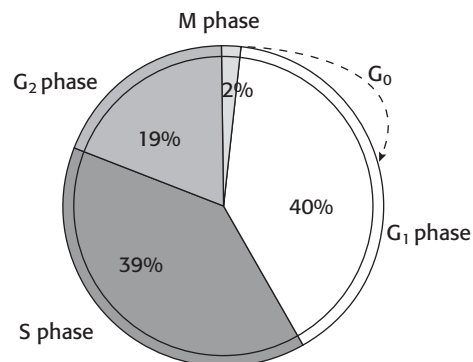

Fig. 11.14 Cell cycle kinetics.

2. **Synthetic phase (S phase):** DNA synthesis takes place.
3. **G₂ phase (premitotic phase):** Synthesis of cellular components for mitosis (proteins and RNA synthesis).
4. **Mitotic phase (M phase):** Mitotic cell division takes place.
5. **G₀ phase (resting phase):** Cells stop dividing temporarily or permanently.

Cell cycle-specific drugs (CCS) or phase specific

Antimetabolites: Methotrexate, 6-mercaptopurine (6-MP)
Antibiotic: Bleomycin
Taxane: Paclitaxel
Epipodophyllotoxins: Etoposide, teniposide
Vinca alkaloids: Vinblastine, vincristine



CCS drugs act mainly on dividing cells

Cell cycle non-specific (CCNS) or phase non-specific drugs

Alkylating agents: Cyclophosphamide, busulphan, mechlorethamine, melphalan
Anticancer antibiotics: Doxorubicin, daunorubicin, mitomycin, actinomycin D
Metal complexes: Cisplatin, carboplatin



CCNS drugs act on dividing as well as resting cells

Classification of Anticancer Drugs

1. **Alkylating agents**
 - a. **Nitrogen mustards:** Mechlorethamine, cyclophosphamide, melphalan, chlorambucil.
 - b. **Alkyl sulphonate:** Busulphan.
 - c. **Nitrosoureas:** Carmustine, lomustine.
 - d. **Platinum-containing compounds:** Cisplatin, carboplatin.
 - e. **Triazene:** Dacarbazine.
2. **Antimetabolites:**
 - a. **Folate antagonist:** Methotrexate.
 - b. **Purine antagonists:** 6-Mercaptopurine (6-MP), 6-thioguanine (6-TG).
 - c. **Pyrimidine antagonists:** 5-Fluorouracil (5-FU), cytarabine.
3. **Vinca alkaloids:** Vinblastine, vincristine.
4. **Taxanes:** Paclitaxel, docetaxel.
5. **Epipodophyllotoxins:** Etoposide, teniposide.
6. **Camptothecins:** Topotecan, irinotecan.
7. **Antibiotics:** Actinomycin D, bleomycin, mitomycin C, doxorubicin, daunorubicin.
8. **Enzymes:** L-Asparaginase.

Major groups of anticancer drugs

1. Alkylating agents
2. Antimetabolites
3. Natural products
 - Vinca alkaloids
 - Epipodophyllotoxins
 - Taxanes
 - Antibiotics
 - Camptothecins
 - Enzymes
4. Miscellaneous agents
 - Hydroxyurea
 - Imatinib
5. Hormones and antagonists

9. **Miscellaneous agents:** Hydroxyurea, imatinib.
10. **Hormones and antagonists:** Glucocorticoids, estrogens, antioestrogens, progestins, androgens and antiandrogens.

■ Toxicity of Anticancer Drugs (Cytotoxic Drugs)

While destroying cancer cells, anticancer drugs also affect rapidly proliferating normal cells. Bone marrow, skin, hair, gastrointestinal mucosa, reticuloendothelial (RE) system, gonads, foetus, etc. are most severely affected.

1. General toxicity

- a. **Bone marrow suppression:** It manifests as leukopaenia, agranulocytosis, thrombocytopenia and aplastic anaemia. In such patients, infection and bleeding are common.
Ameliorated/reduced by:
 - i. Platelet transfusion
 - ii. Granulocyte colony-stimulating factor (G-CSF)
 - iii. Erythropoietin
 - iv. Bone marrow transplantation
 - v. Using bone marrow-sparing drugs if possible (e.g. L-asparaginase, bleomycin, cisplatin, vincristine).
- b. **Immunosuppression:** Decreased lymphocytes result in immunosuppression. Such patients are prone for opportunistic infections with fungi, bacteria, viruses, parasites (*P. jiroveci*, *Candida*, CMV, etc.).
- c. **Oral cavity:** Mucositis, oral ulceration, stomatitis, xerostomia, infections (*Candida*, herpes, etc.), gingival bleeding and mucosal petechiae due to thrombocytopenia. Mucositis is ameliorated by oral cooling using ice chips, topical agents like benzydamine (rinse or spray), 2% viscous lignocaine and chlorhexidine mouth rinses.
- d. **GIT:** Nausea and vomiting are due to central action (stimulation of CTZ) and peripheral action in GI tract. Most of the cytotoxic drugs cause vomiting. Cisplatin has the most emetogenic potential. 5-HT₃ antagonists such as ondansetron and granisetron are the commonly used antiemetics. The other antiemetics are metoclopramide and dexamethasone. Stomatitis, oral mucositis, diarrhoea, GI bleeding and ulcers are due to necrosis of rapidly dividing epithelial cells of gut mucosa.
- e. **Skin and hair:** Alopecia (loss of hair) is due to the damage to hair follicles. Alopecia is usually reversible on stoppage of therapy. Dermatitis and skin rashes too can occur.
- f. **Gonads:** Cytotoxic drugs also affect gonadal cells and cause oligozoospermia and infertility in males, and amenorrhoea and infertility in females.
- g. **Foetus:** Administration of cytotoxic drugs during pregnancy usually causes abortion or teratogenic effects.
- h. **Hyperuricaemia:** Gout and urate stones in the urinary tract are due to excessive cell destruction. They are prevented by good hydration, allopurinol and corticosteroids.
- i. **Hypercalcaemia:** It may be either due to the malignancy or certain anticancer drugs. It is treated with adequate hydration, bisphosphonates, corticosteroids, etc.
- j. **Carcinogenicity** (secondary malignancy): These drugs may rarely cause secondary cancers in some patients, e.g. development of leukaemia in patients with prolonged use of alkylating agents.
- k. **Mutagenicity.**

2. Specific toxicity

- Haemorrhagic cystitis with cyclophosphamide:** Ameliorated by administering mesna systemically and acetylcysteine locally.
- Megaloblastic anaemia with methotrexate:** Ameliorated by folic acid/leucovorin/citrovorum factor.
- Nephrotoxicity with cisplatin:** Infusion of saline and mannitol reduces the incidence of nephrotoxicity.
- Neuropathy with vincristine and paclitaxel.**
- Pulmonary fibrosis and pigmentation of skin with busulphan and bleomycin.**
- Cardiotoxicity with doxorubicin and daunorubicin.**

■ Alkylating Agents

All alkylating agents have alkyl group(s) and are capable of introducing these groups into nucleophilic sites on DNA bases through the formation of covalent bonds. Alkylating agents are CCNS drugs. They also have radiomimetic effect.

Mechanism of action

Alkylating agents (except platinum containing compounds)

↓
Form highly reactive carbonium ion

↓
Transfer of 'alkyl' group(s) to various sites on DNA

↓
Results in

- Cross-linkage (inhibits DNA replication).
- Abnormal base pairing (alkylated guanine base pairs with thymine rather than cytosine and results in production of defective protein).
- Break in the DNA strands.

↓
Cell death

Alkylating agents can also bind to proteins and damage them.

■ Nitrogen Mustards

Cyclophosphamide

Cyclophosphamide is a prodrug and is activated in liver (Fig. 11.15). The final active metabolites derived from cyclophosphamide are phosphoramidate mustard and acrolein. Phosphoramidate mustard produces cytotoxic effect and acrolein is responsible for haemorrhagic cystitis.

Cyclophosphamide is administered orally or intravenously. The metabolites are excreted mainly in urine.

Adverse effects

General toxicity (see p. 359). The specific toxicity of cyclophosphamide is severe haemorrhagic cystitis. It is associated with dysuria and haematuria due to irritation of bladder mucosa by acrolein. It is a

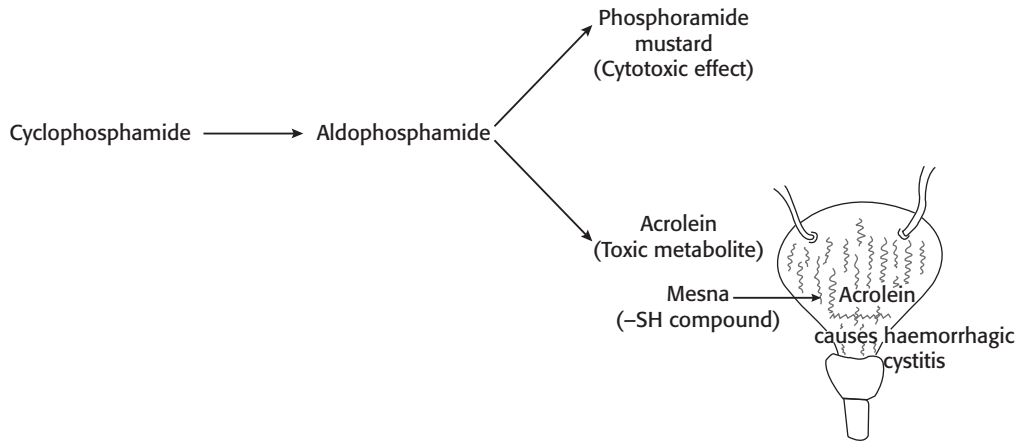

Fig. 11.15 Cyclophosphamide and haemorrhagic cystitis.

dose-limiting toxicity and can be reduced by adequate hydration and co-administration of i.v. mesna (2-mercapto-ethane-sulphonate). Mesna is also excreted in urine where it binds and inactivates acrolein, thus preventing haemorrhagic cystitis.

Uses

Cyclophosphamide is used in combination with other anticancer agents in the treatment of lymphomas, chronic lymphocytic leukaemia, breast cancer, etc. It also has powerful immunosuppressant effect; hence, it is useful in rheumatoid arthritis, nephrotic syndrome and to prevent as well as to treat graft rejection during organ transplantation.

Ifosfamide is a congener of cyclophosphamide and is administered intravenously. It is useful in the treatment of testicular cancer and sarcomas.

Mechlorethamine

It is one of the drugs useful for the treatment of Hodgkin's disease. It is a highly irritant drug, so care should be taken to avoid extravasation during i.v. administration.

Chlorambucil

It is a slow-acting nitrogen mustard. Its main action is on lymphoid series, and it produces marked lympholytic effect. It is given orally and was the standard treatment for chronic lymphocytic leukaemia (CLL).

Melphalan

It is effective in multiple myeloma and is used in combination with other agents.

Alkyl Sulphonates

Busulphan

It depresses bone marrow with selective action on myeloid series. It was the preferred drug for chronic myeloid leukaemia (CML). The common side effects are pigmentation of the skin, interstitial pulmonary fibrosis and hyperuricaemia.

◆ Nitrosoureas

Carmustine and lomustine are highly lipid soluble drugs; hence, they reach high concentration in the CSF. Nitrosoureas are mainly used in brain tumours.

◆ Platinum-containing Compounds

Cisplatin

It is a heavy-metal complex with highly effective antineoplastic activity. It is a CCNS drug and acts on both dividing as well as resting cells. Cisplatin is administered intravenously. It is highly bound to plasma proteins and gets concentrated in kidney, liver, intestines and testes. It poorly penetrates BBB and is slowly excreted in urine.

Mechanism of action

Inside the cell,

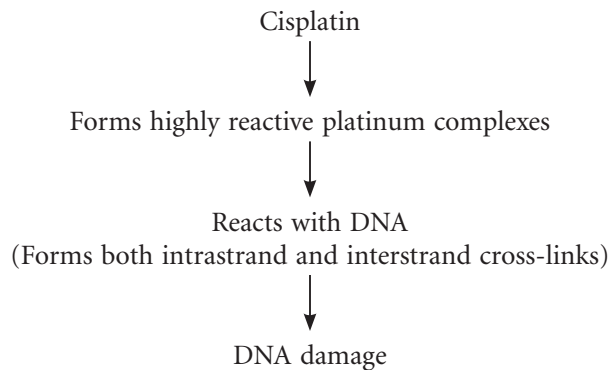

Cisplatin is highly effective in the treatment of testicular, ovarian, endometrial and bladder cancer. It is also used in lung and oesophageal cancer.

Adverse effects

Cisplatin is the most emetogenic anticancer drug. Vomiting can be controlled by 5-HT₃ antagonists such as ondansetron or granisetron.

Nephrotoxicity: It can be minimized by proper hydration and chloride diuresis.

Ototoxicity with hearing loss can occur and is severe with repeated doses.

Electrolyte disturbances: Hypokalaemia, hypocalcaemia and hypomagnesaemia are common. Neuropathy is commonly seen with higher doses. Rarely, anaphylactic shock may occur. Cisplatin has mutagenic, teratogenic and carcinogenic properties.

■ Antimetabolites

◆ Folate Antagonist

Methotrexate (Mtx)

Methotrexate is one of the most commonly used anticancer drugs. It is a cell cycle specific (CCS) drug and acts during S phase of the cell cycle. It has antineoplastic, immunosuppressant and anti-inflammatory effects.

Mechanism of action

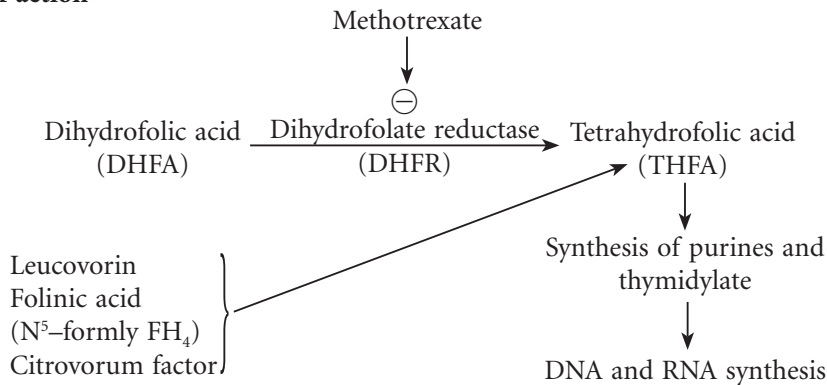

Methotrexate structurally resembles folic acid. It competitively inhibits dihydrofolate reductase enzyme and prevents the conversion of DHFA to THFA, thus depleting the intracellular THFA. Tetrahydrofolic acid is necessary for the synthesis of purines and thymidylate, which, in turn, are necessary for DNA and RNA synthesis.

Methotrexate is well absorbed after oral administration and can also be given i.m., i.v. or intrathecally. It is bound to plasma proteins, poorly crosses the BBB, and most of the drug is excreted unchanged in urine.

Methotrexate is the drug of choice for choriocarcinoma. It is also used in acute leukaemias, Burkitt's lymphoma and breast cancer.

Adverse effects

See general toxicity (p. 359). Other adverse effects are megaloblastic anaemia, pancytopenia, hepatic fibrosis, etc.

Folinic acid rescue/leucovorin rescue

The toxic effects of methotrexate on normal cells can be minimized by giving folinic acid. Availability of folinic acid has helped the use of very high doses of methotrexate for better antineoplastic effect. After a few hours of methotrexate therapy, leucovorin is given. Folinic acid is the active coenzyme form. It bypasses the block produced by methotrexate and rapidly reverses the toxicity. This method is called as leucovorin rescue/folinic acid rescue.

► Purine Antagonists: 6-Mercaptopurine (6-MP) and 6-Thioguanine (6-TG)

6-Mercaptopurine (6-MP) and 6-thioguanine (6-TG) are activated to their ribonucleotides, which inhibit purine ring biosynthesis and nucleotide interconversion. They are CCS drugs that act in S phase of cell cycle. 6-MP also has immunosuppressant action.

6-MP is administered orally and has poor penetration through the BBB. It is metabolized by xanthine oxidase and its metabolite is excreted in urine.

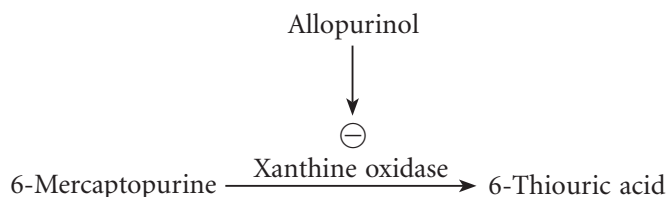

Allopurinol interferes with the metabolism of 6-MP by inhibiting the enzyme xanthine oxidase and increases the antineoplastic effect of 6-MP. Therefore, allopurinol is frequently used in cancer patients receiving chemotherapy to prevent hyperuricaemia and to reduce the dose of 6-MP, thus reducing its toxicity. 6-MP is used mainly in acute lymphocytic leukaemia. Bone marrow depression is the major adverse effect of 6-MP.

Pyrimidine Antagonists

Fluorouracil (5-FU)

5-Fluorouracil interferes with DNA synthesis. It is used in gastrointestinal tract (GIT), breast, ovary, skin, recurrent/metastatic salivary gland tumours, etc.

Plant Products

Vinca Alkaloids

Vinblastine and vincristine are derived from the periwinkle plant. They are CCS agents and act during M phase of cell cycle. Vinblastine and vincristine have the same mechanism of action but differ in antitumour spectrum and toxicity (Table 11.19).

Table 11.19 Uses and Adverse Effects of Vinca Alkaloids

Vinblastine	Vincristine
Uses: Hodgkin's disease Carcinoma Breast Testicular tumours	Uses: Childhood leukaemias Childhood tumours—Wilm's tumour, neuroblastoma Hodgkin's disease
Toxicity: Bone marrow suppression, anorexia, nausea, vomiting and diarrhoea	Toxicity: Peripheral neuritis with paraesthesia, constipation. Vincristine has minimal myelosuppressive action.

Mechanism of action

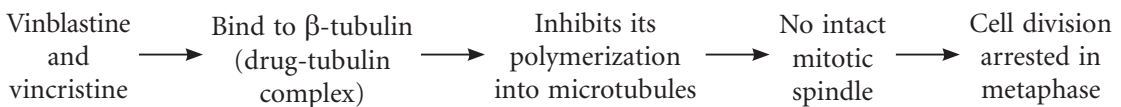

Taxanes

Paclitaxel is a taxane derived from the bark of the Western yew tree. Docetaxel is a newer taxane.

Mechanism of action

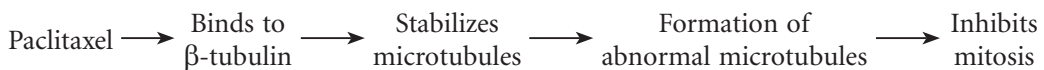

Paclitaxel is administered by i.v. infusion. It is useful in advanced breast, ovarian, lung, oesophageal and bladder cancer. The unwanted effects are bone marrow suppression, peripheral neuropathy, myalgia and hypersensitivity reactions.

■ Anticancer Antibiotics

Mechanism of action

Anticancer antibiotics have direct action on DNA and interfere with cell division.

▶ Bleomycin

It is used in squamous cell carcinoma of the skin, carcinoma of oral cavity, head and neck cancer. Its main side effects are hyperpigmentation of skin and pulmonary fibrosis. There is very little bone marrow suppression (sparing bone marrow).

▶ Doxorubicin and Daunorubicin

Daunorubicin is effective in acute leukaemias; doxorubicin is active against solid tumours. The side effects are bone marrow suppression, GI disturbances and cardiomyopathy with CCF, hypotension or arrhythmias.

▶ Actinomycin D

It is administered intravenously. It is used in the treatment of Wilm's tumour and choriocarcinoma. Bone marrow suppression and gastrointestinal side effects are prominent.

▶ Mitomycin C

It is converted to a compound that acts as an alkylating agent. It is mainly used in the treatment of GI tumours, cervix and bladder cancer. It produces bone marrow suppression, gastrointestinal side effects and nephrotoxicity.

▶ Mithramycin

It is an anticancer antibiotic that reduces blood calcium levels by inhibiting osteoclasts. It is used in the treatment of hypercalcaemia with bone metastasis.

■ Enzyme

▶ L-Asparaginase

It is an enzyme that is isolated from bacteria, *E. coli*. Asparagine is an amino acid that is necessary for protein synthesis. Normal cells can synthesize asparagine because they contain asparagine synthetase enzyme. Cancer cells lack this enzyme, so they depend on exogenous source—plasma.

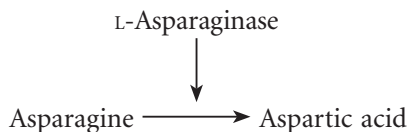

L-Asparaginase degrades asparagine to aspartic acid. Hence, neoplastic cells are deprived of asparagine, resulting in cell death. It is used in the treatment of ALL (acute lymphocytic leukaemia).

Toxicity

1. Hypersensitivity reaction with skin rashes, itching, urticaria, etc.
2. Hyperglycaemia: Due to insulin deficiency.
3. Headache, Hallucinations, confusion and coma.
4. Haemorrhage: Due to inhibition of synthesis of clotting factors.
5. Pancreatitis.

Hormonal Agents

Hormones produce only palliative effects in cancer.

1. **Glucocorticoids:** Because of their marked lympholytic action, they are used in acute leukaemias and lymphomas. Apart from this effect, glucocorticoids:
 - a. have antiinflammatory effect, decrease oedema associated with the tumour.
 - b. produce feeling of well-being.
 - c. suppress hypersensitivity reaction due to certain anticancer drugs.
 - d. control hypercalcaemia.
 - e. increase the antiemetic effect of ondansetron/granisetrone/metoclopramide.Because of the above effects, glucocorticoids are useful in the treatment of various cancers.
2. **Others are oestrogens, progestins, tamoxifen, and antiandrogens, finasteride, etc.**

Key Point for Dentists

- ↳ Patients on anticancer drugs should maintain adequate hydration and good oral hygiene.

FLUORIDES

Fluoride occurs naturally in food and water. It is absorbed mainly in the intestine. It is widely distributed but is concentrated in teeth and bones. The kidney is the major route of excretion.

■ Actions on Teeth

Teeth are composed mainly of calcium hydroxyapatite. Fluoride exchanges with hydroxyl ions to form calcium fluorapatite, which is more stable in acid than calcium hydroxyapatite. This makes outer layers of the enamel harder, so the teeth are resistant to acid attack. Fluoride prevents decalcification of enamel by acids and prevents caries. It promotes re-mineralization of enamel, which has been demineralized. It is concentrated in plaque and inhibits microbial enzymes required for acid production.

■ Use of Fluorides

Dental caries: Caries is a degenerative condition characterized by disintegration of teeth starting from the periphery in the enamel and gradually extending to the pulp/soft tissues. Microorganisms present in the oral cavity act upon residual carbohydrates to produce acids. Acids attack the teeth leading to demineralization of enamel and finally cavitation. There is increased incidence of dental caries in areas where drinking water is deficient in fluorides. Fluorides are used in the form of fluoridated drinking water, supplements, toothpaste, gel and foam, varnish and mouthwash.

■ Fluoridation of Drinking Water

Fluoridated drinking water has optimal concentration of fluoride and is effective in preventing caries in children and adults. The optimal level of fluoride in drinking water is 1 ppm. This optimal level occurs either naturally or is obtained by addition of fluoride to community water supply (sodium fluoride is used).

■ Fluoridated Toothpaste

On brushing, fluoride in toothpaste is taken up by plaque and demineralized enamel. Its concentration is also transiently increased in saliva from where it is taken up by the plaque. Sodium fluoride, sodium monofluorophosphate and stannous fluoride are the commonly used fluoride salts.

◆ Fluoride Mouthrinse

The fluoride of mouthrinse is retained in the plaque and saliva, and helps prevent dental caries. Sodium fluoride 0.20% solution (920 ppm fluoride) and stannous fluoride 0.63% solution is available. They can be used daily or weekly, as prescribed by the dentist. Mouthrinse should not be swallowed. To maximise the benefit, patient should be advised not to eat, drink or rinse the mouth for at least 30 min after using a mouthrinse.

◆ Fluoride Supplements

They can reduce the incidence of caries in primary and permanent teeth of children. They are prescribed to children between 6 months and 16 years of age in areas where drinking water is nonfluoridated or has low-fluoride content. The decision to prescribe fluoride supplements should be based upon the risk of developing caries, the fluoride content of drinking water, use of other sources of fluorides (toothpaste, mouthrinse) and age of the child. They are not recommended for children below 6 months of age. Irrational use of fluoride supplements can result in fluorosis. Sodium fluoride supplements are available as tablets, lozenges and liquids. The dose of supplements ranges from 0.25 to 1 mg/day. The tablet/lozenge should be chewed and then swallowed. Dairy products should be avoided 1 h before and after intake of chewable fluoride tablets.

◆ Gel and Foam

Gel of acidulated fluoride phosphate (1.23%), foam or gel (2%) of sodium fluoride, or gel of stannous fluoride is available. A contact time of 4 min is required. They are applied at 3–6-months' interval. Care should be taken not to swallow the preparation.

◆ Fluoride Varnish (5% Sodium Fluoride)

It is applied directly on the teeth by a dentist and is retained on the teeth for hours. A small quantity of the preparation contains a high concentration of fluoride. It is easy to apply; moreover, only small amount of the preparation is required as compared to gel.

Sodium fluoride 5% varnish is commonly used. It is applied at 3–6-month interval, as directed by the dentist.

■ Fluoride Toxicity

◆ Acute Fluoride Toxicity

It occurs due to accidental ingestion of fluoride-containing insecticides. It manifests as nausea, vomiting, abdominal pain, diarrhoea, hypotension, hypocalcaemia, etc. Gastric lavage is done with calcium salts to precipitate fluorides. Intravenous glucose is also administered.

◆ Chronic Fluoride Toxicity

Chronic fluoride toxicity, resulting in dental fluorosis, occurs where drinking water has large amount of fluorides. In mild cases, white opaque spot is seen on the teeth. In severe cases, brown pits are seen on the teeth, giving the teeth an irregular appearance.

ASTRINGENTS

Agents that act by reacting with and precipitating proteins in superficial cells to form a protective covering on the surface are called astringents. This covering over the underlying tissue:

- protects against bacteria and irritants.
- decreases exudation.
- arrests capillary oozing when applied to bleeding surfaces.

Types of Astringents

- Vegetable astringents
- Metallic astringents
- Others: Alcohol (not used as astringent in oral cavity)

Vegetable Astringents

- Tannic acid:** It is a light-brown powder soluble in glycerin and alcohol.
- Catechu:** Its astringent action is due to the presence of tannic acid.

Metallic Astringents

- Aluminium salts:** For example, alum, aluminium acetate. Alum is aluminium potassium sulphate or aluminium ammonium sulphate. It can be used as a solution or powder. As it is acidic, it may damage the enamel. Aluminium acetate is less irritating.
- Zinc salts:** For example, zinc chloride, zinc sulphate, zinc oxide. They have astringent and antiseptic properties. They do not stain the teeth. Zinc sulphate is less irritating to the oral mucosa than zinc chloride. The astringent action of zinc oxide is weaker as compared to other zinc salts.
- Ferric chloride:** Its use as an astringent has declined as it can stain the teeth and damage the enamel.
- Silver nitrate and copper sulphate:** They stain the teeth.

Uses of Astringents

As mouthwash, paint, dentifrices, mummifying agents, obtundents, and styptics in gingivitis, aphthous ulcers, bleeding gums and halitosis.

DESENSITISING AGENTS

Dentinal hypersensitivity is a sharp dental pain usually provoked by thermal, chemical, tactile or osmotic stimulation of exposed dentinal tubules. These stimuli cause changes in the direction of fluid movement within the dentinal tubules, which is perceived as pain.

An ideal desensitising agent should be rapid acting, have a long duration of action, nonirritant, easy to apply and should not stain the teeth.

Dentinal hypersensitivity is treated by:

- Desensitising the nerve:** By blocking the transmission of neural signals by topical application of potassium nitrate, e.g. 3% potassium nitrate mouthrinse or 5% potassium nitrate toothpaste.

The exact mechanism of action is not clear. There is an increase in extracellular potassium levels in the dentine cavities, which blocks the generation of action potential in the pulpal nerves.

2. Occluding the dentinal tubules

- a. *Salts*: Stannous fluoride, sodium fluoride, potassium oxalate, strontium chloride, etc. Fluorides, oxalates and chloride-containing compounds help to seal the surface of the dentine, decrease movement of fluid in the tubules and diminish dentine hypersensitivity. Application of sodium and stannous fluoride results in precipitation of calcium fluoride crystals, which act as a barrier in the dentinal tubules. But the calcium fluoride formed dissolves in saliva; hence it has a transient action. Potassium oxalate reacts with calcium in the dentine to form calcium oxalate on the surface of the dentine and inside the tubules. The drawback of this preparation is that the calcium oxalate formed on the surface is lost following regular brushing of the teeth.
- b. *Agents that precipitate proteins*: Glutaraldehyde, zinc chloride, silver nitrate. By precipitating proteins, they occlude the tubules and decrease movement of fluid. Use of silver nitrate can result in blackening of tooth surface.
- c. *Resins and dental adhesives* seal the open dentine tubules and diminish sensitivity.

Desensitising agents are available as gel, dentifrices, mouthwash; or they can be applied topically as varnish, adhesives, resin, glass ionomer composite, etc. Depending on the agent, they can be applied either by the patient or the dentist.

Uses: Desensitising agents are used to treat dentinal hypersensitivity due to gingival recession, abrasion and erosion of tooth surface. They can also be used to decrease sensitivity after periodontal treatment. Potassium nitrate can be used before and during tooth bleaching to reduce dentine sensitivity.

Key Points for Dentists

- Caries can be prevented by maintaining good oral hygiene and use of fluorides.
- Drawback of stannous fluoride is its propensity to stain teeth.
- Excessive ingestion of fluorides can lead to fluorosis.

ANTICARIES AGENTS

Dental caries is common in children and young adults, but can occur in any age group (see p. 367). There are various ways of controlling dental caries. Primary preventive measures for controlling caries include use of fluorides, pit and fissure sealants, and dietary modification.

■ Fluorides

Fluorides are effective anticaries agents and their use has reduced the incidence of dental caries. Fluoride inhibits demineralization and promotes re-mineralization of the enamel. It improves the structure of enamel—makes it more acid resistant. It also has antimicrobial actions—thereby inhibiting fermentation of carbohydrates and acid production. Fluorides are administered in the form of fluoridated drinking water, dentifrice, mouthrinse, gel, foam, varnish and supplements. (See p. 367–368 for details)

■ Nonfluoride Agents

Certain nonfluoride agents may provide some benefit as adjunct to primary prevention measures in children and adults at high risk of developing caries.

Chewing of sucrose-free polyol gum (containing either xylitol only or polyol combinations) for 10–20 min after meals can be used in children (>5 years) and adults at high risk of developing caries. Xylitol has antimicrobial effects and inhibits acid production in the oral cavity.

A 1:1 mixture of chlorhexidine/thymol varnish may be efficacious in the prevention of root caries in adults and elderly.

Calcium and phosphate in a toothpaste or mouthrinse will increase the concentration of these ions in the oral cavity and improve remineralization. Triclosan has antimicrobial and antiinflammatory effects. Chlorhexidine has broad-spectrum antimicrobial effects. But there is not sufficient evidence that nonfluoride agents like calcium and/or phosphate agents (with or without casein derivatives), topical chlorhexidine alone and triclosan can reduce the incidence of caries.

■ Prevention of Caries

- The public, especially children should be educated about good oral hygiene, proper use of toothbrush, dental floss, etc. Brushing of teeth should be done twice daily.
- Carbohydrate-containing foods like ice-cream, chocolates, etc. should be avoided.

Key Points for Dentists

- Fluoride supplements should be stored away from young children.
- Fluoridated toothpaste should be cautiously used in children below 6 years of age, as they are more likely to swallow the toothpaste instead of spitting it out.

ANTIPLAQUE AGENTS

Dental plaque consists of a wide range of bacteria in a matrix of food debris, bacterial polysaccharides and salivary proteins. Plaque plays an important role in the initiation of caries and can cause gingival inflammation, which can progress to periodontal disease.

A good antiplaque agent should have prolonged retention time on the oral surface and broad spectrum of antibacterial action with minimal side effects.

The following agents are used as mouthwash or dentifrice for their antiplaque actions.

- **Fluorides:** Stannous fluoride, sodium fluoride, organic amine fluoride
- **Bis-biguanides:** Chlorhexidine, bis-pyridine
- **Quarternary ammonium compounds:** Benzalkonium chloride, cetylpyridinium chloride
- **Phenols and essential oils:** Triclosan, thymol, eucalyptol, menthol
- **Enzymes:** Amyloglucosidase, glucose oxidase, protease, lipase
- **Antiseptics:** Povidone iodine, chloramine
- **Alkaloids:** Sanguarine
- **Detergent:** Sodium lauryl sulphate
- **Metals:** Zinc, tin
- **Antimicrobials:** Penicillin, tetracycline, gramicidin

Some of the commonly used agents are discussed below.

■ Fluorides

Stannous fluoride is more effective than sodium fluoride as an antiplaque agent. Stannous fluoride reduces *Streptococcus mutans* and *Streptococcus sanguis* in plaque and *S. mutans* in saliva. Stannous

fluoride-treated enamel is more resistant to colonization by bacteria. It also inhibits bacterial glycolysis by oxidizing thiol group of enzymes involved in the process. It is available as a component of toothpaste and mouthwash. Adverse effect is staining of the teeth.

■ Enzymes

Amyloglucosidase and glucose oxidase activate the lactoperoxidase system in saliva, which converts salivary and exogenous thiocyanate to hypothiocyanite. The hypothiocyanite formed has inhibitory effect on bacterial growth. Enzymes like dextranases, mutanase and proteases are plaque-removal agents; but they cause mucosal erosion.

■ Metal Ions

Zinc ions in the form of citrate and chloride are used as antiplaque agents in toothpaste and mouthwash. Zinc ions inhibit conversion of glucose to lactic acid by inhibiting enzymes of glycolysis in bacteria. They also inhibit enzymes required for glucose uptake by *S. sanguis* and *S. mutans*.

■ Triclosan

It has a broad spectrum of antibacterial effect. It damages the bacterial cytoplasmic membrane, leading to leakage of cellular contents. It also has antiinflammatory effects. Optimal antiplaque effect is achieved when triclosan is combined with a copolymer. The latter increases the period of retention of triclosan in the oral cavity. Triclosan does not cause staining of the teeth.

■ Chlorhexidine

It has antiinflammatory and a broad-spectrum antibacterial effect. It has prolonged oral retention time. Its antiplaque action is decreased by stannous fluoride and sodium lauryl sulphate. Rinsing with chlorhexidine should be avoided after use of toothpaste. Drawbacks are its taste and ability to cause staining of the teeth and tongue.

■ Essential Oils

Essential oils like thymol, menthol and eucalyptol affect bacterial cell wall to produce antibacterial activity. They help to reduce plaque.

■ Quarternary Ammonium Compounds

They alter the permeability of the bacterial cell membrane resulting in leakage of cell contents. They are effective against both gram-positive and gram-negative bacteria. They are used as mouthrinse. They have a short retention time in the oral cavity.

■ Others

Sodium lauryl sulphate produces antiplaque effect by inhibiting the enzyme glucosyltransferase, which plays a role in colonisation of enamel by *S. mutans*.

Sanguarine has doubtful efficacy as antiplaque agent.

DENTIFRICES

Agents used with toothbrush to clean and polish the teeth. They can be in the form of paste, gel or powder.

An ideal dentifrice:

- should be nonirritant.
- should not demineralize the enamel.
- should have pleasant taste and odour.
- should not produce marked abrasion on the teeth.

The ingredients include:

Active ingredients

1. Anticaries agents
2. Anticalculus agents
3. Antiplaque or antigingivitis agents
4. Desensitising agents
5. Antihalitosis agents

Inactive ingredients

1. Abrasives
2. Binders
3. Humectants
4. Surfactants/detergents
5. Buffering agents
6. Sweetening agents
7. Flavouring agents
8. Dyes
9. Titanium dioxide
10. Preservatives

Active Ingredients

1. **Anticaries agents:** They are fluorides like sodium fluoride, sodium monofluorophosphate, amine fluoride and nonfluorides like xylitol, calcium and/or phosphate, metals (zinc, aluminium), etc.
 - i) **Fluorides:** Fluoride exchanges with hydroxyl ions to form calcium fluoroapatite, which is more stable in acid than calcium hydroxyapatite. This makes outer layers of the enamel harder, so teeth are resistant to acid attack. It prevents decalcification of enamel by acids and prevents caries. Sodium fluoride and stannous fluoride are the commonly used fluoride salts (see p. 367).
 - ii) **Xylitol:** It is a nonfermentable sugar; hence demineralizing acids are not produced—help to prevent caries. Xylitol is not used by the bacteria as an energy source, thereby prevents bacterial growth and multiplication. It is present as an anticaries agent in toothpastes and some chewing gums.
2. **Anticalculus (antitartar agents):** Calculus or tartar is a form of mineralized and hardened dental plaque. It is caused by the continual accumulation of minerals from saliva and gingival fluid on teeth.

Anticalculus agents are tetrapotassium and sodium pyrophosphate, zinc compounds, and triclosan/copolymer.

 - i) **Tetrapotassium and sodium pyrophosphate:** They stabilise the calcium level in the saliva and affect the growth of calculus. They also have antimicrobial actions.
 - ii) **Zinc compounds:** For example, zinc citrate inhibits plaque formation and bacterial growth. It inhibits crystal growth.

- iii) **Triclosan/copolymer (polyvinylmethylether/maleic acid):** It has antibacterial and anti-inflammatory action, hence reduces plaque formation and gingivitis. The copolymer helps to retain the triclosan intraorally for a longer period of time.
- 3. **Antiplaque (antigingivitis agents):** They include triclosan/copolymer, stannous fluoride, zinc citrate, etc.
- 4. **Desensitising agents:** They are potassium nitrate, citrate and chloride, stannous fluoride or strontium chloride. They reduce dentinal hypersensitivity by blocking the transmission of neural signals or occluding dentinal tubules.
- 5. **Antihalitosis agents:** They include essential oils, chlorine dioxide, triclosan/copolymer, stannous fluoride, sodium hexametaphosphate. Zinc salts reduce halitosis by inhibiting production of volatile sulphur compounds.

■ Inactive Ingredients

- 1. **Abrasive agents:** For example, calcium carbonate (chalk), dibasic calcium phosphate, silica, magnesium carbonate, aluminium oxide, magnesium trisilicate, etc. They are fine powders used to clean and polish the teeth by mechanical action. They should remove debris and stain from the teeth without causing marked abrasion on the teeth.
- 2. **Binding agents:** They bind the solid and liquid phases in toothpaste and stabilise the toothpaste. They are not present in toothpowder. They could be natural, e.g. gum arabic, mucilage of tragacanth, bentonite or synthetic like sodium carboxymethyl cellulose, magnesium aluminium silicate, etc.
- 3. **Humectants:** They are present in toothpaste only, e.g. glycerine, sorbitol and polypropylene glycol ether. They are also known as antidrying agents. They prevent loss of water from the paste, thus preventing it from becoming hard.
- 4. **Detergents:** They generate foam and decrease surface tension. They help to loosen deposits from the surface of teeth while cleaning, breaking down stains and deposits, e.g. sodium lauryl sulphate, sodium lauryl sarcosinate, sodium stearyl fumarate. Sodium lauryl sarcosinate also inhibits hexokinase (an enzyme that converts sugar to acids) and has bacteriostatic action. Sodium lauryl sulphate can cause aphthous ulcers.
- 5. **Buffering agents:** They control the pH of the toothpaste, ensuring that it is neither too acidic nor too alkaline. Sodium bicarbonate neutralises acid formed as a result of action of bacteria on food lodged in between the teeth. It also acts as a mild abrasive and helps to remove superficial stains on the teeth. It has antibacterial action.
- 6. **Sweetening agents:** They give a sweet taste to the toothpaste and improve its taste, e.g. saccharin sodium, sucrose, lactose, sorbitol, etc. Saccharin is the commonly used sweetener, as it is a noncarbohydrate and does not undergo fermentation. Xylitol is a sweetener that does not undergo fermentation and also has anticaries effect.
- 7. **Flavouring agents:** They include peppermint oil, oil of wintergreen in combination with essential oils of clove, eucalyptus, cinnamon, etc. They make the toothpaste more palatable, provide a fresh sensation during and after brushing, and help to mask the taste of detergents.
- 8. **Dyes/Colouring agents:** They are used for cosmetic purposes to make the toothpaste attractive, e.g. titanium dioxide for white pastes and food dyes for coloured pastes, e.g. liquor rubri (red colour), methylene blue (blue colour), chlorophyll (green colour), etc.
- 9. **Preservatives:** Sodium benzoate, methylparaben and ethylparaben—prevent growth of microorganisms.

10. **Whitening agents:** Abrasives, enzymes (papain), dimethicone, peroxide, sodium tripolyphosphate are some of the whitening agents present in a toothpaste.

■ Uses of Dentifrices

To maintain oral hygiene by removal of food debris and plaque—prevent caries, gingivitis, halitosis, periodontal diseases; for removal of stains on the teeth, etc.

■ Adverse Effects of Toothpaste

Most of the ingredients present in toothpaste have a potential for causing allergic or irritant reactions. The commonly implicated ingredient for such reactions is flavouring agent. Others that have been reported to cause contact allergic reactions include foaming agents (sodium lauryl sulphate), preservatives (sodium benzoate, parabens and polyethylene glycol), essential oils (tea tree oil and propolis) and antibacterials (triclosan). Tartar-control toothpastes containing pyrophosphates have also been reported to cause allergy.

Reactions include cheilitis, circumoral dermatitis, stomatitis, canker sores, etc.

- *Cheilitis* is inflammation of the lips, which is manifested as redness, itching, dryness and scaling.
- *Circumoral dermatitis* is manifested as pruritic perioral erythema. Perioral dermatitis is an inflammatory condition characterised by tiny papules or pustules commonly in the perioral area.
- *Contact stomatitis* can also occur. It affects the gums (gingivitis), tongue (glossitis) and inside of the cheek. Patient complains of burning sensation and pain inside the mouth. There is redness, swelling and peeling of the affected area.

Flavouring agents like peppermint, spearmint, menthol (all derived from mint), cinnamon aldehyde, anethole (derived from anise and fennel) can cause cheilitis and circumoral dermatitis. Propolis (antiseptic) can cause allergic contact cheilitis, stomatitis and perioral eczema.

- *Canker sores* (painful ulcers inside the mouth) can be caused by sodium lauryl sulphate. It causes drying of the soft tissues inside the oral cavity, making them susceptible to irritants in food.
- *Erythema and fissures* in the perioral area can be produced occasionally by antitartar agents like pyrophosphate.

The toothpaste should be discontinued and alternative toothpaste should be used. Some cases may require treatment with steroids.

- *Fluorosis* can occur due to swallowing of toothpaste containing fluorides in children. The risk depends on the amount of toothpaste swallowed and the concentration of fluoride. Children should be encouraged to spit out the excess toothpaste while brushing their teeth.
- Damage to enamel can occur with some whitening agents.

DISCLOSING AGENTS

Agents applied to teeth to reveal the presence of dental plaque (identify plaque). The colouration produced is temporary and makes the plaque visible. Disclosing agents are nonirritants. They are:

1. **Erythrosine:** Most widely used red dye—causes red staining of plaque.
2. **Fluorescent disclosing agents:** For example, 0.75% sodium fluorescein solution—plaque appears bright yellow in normal light and intensive yellow-green under blue light. The disadvantage is the requirement of special light source or filter mirror. Fluorescent-containing dye is ideal for patients who find erythrosine staining objectionable.

3. **Two-tone solution:** It is a multicolouring disclosing agent. Older plaque stains blue, newer plaque stains red.

Disclosing agents are available as tablets or liquids. The tablet is chewed, swished and spit out. Liquid is applied on the teeth with a cotton-tipped applicator or can be rinsed with a small amount of water and spit out. Patient should be informed that there will be a change in colour of oral cavity by the agent, which is temporary.

BLEACHING AGENTS

Tooth whitening or bleaching has become a popular aesthetic dental treatment. Though both terms are used interchangeably, 'whitening' refers to restoration of normal tooth colour whereas 'bleaching' results in whitening of the teeth beyond their natural colour. Surface whiteners remove surface stains. Bleaching agents are used to remove deep (intrinsic) and surface (extrinsic) stains on the teeth. Tetracycline and high levels of fluorides cause intrinsic staining of the teeth. Extrinsic staining can occur due to aging, smoking, beverages, food, trauma, etc. Demineralization in caries can cause both intrinsic and extrinsic staining of teeth.

Bleaching agents can be administered either by the dentist in office or by the patients themselves at home. They are used in the form of trays, strips, toothpaste, mouth rinses, gums, gels, paint-on products, etc. Ideally, tooth bleaching should be done after a proper dental examination and diagnosis, and under professional supervision. The result of bleaching depends on the type of stain, concentration and contact time of the bleaching agent, frequency of application and age of the patient.

The **commonly used** bleaching agents are primarily peroxides—carbamide peroxide and hydrogen peroxide.

1. **Hydrogen peroxide:** Hydrogen peroxide breaks down into water and free oxygen radicals. The free radicals bind to the stain and decolourise it through an oxidation reaction. The liberation of nascent oxygen is accelerated by application of heat or light. Hydrogen peroxide containing mouthrinse and strips are available.
2. **Carbamide peroxide (concentration between 10 and 38%):** On contact with saliva, it breaks down to liberate hydrogen peroxide (it is the active bleaching agent) and urea. Application of 10% carbamide peroxide in a tray worn for 2 weeks is a commonly used bleaching procedure. A paint-on liquid and gel containing carbamide peroxide is available.
3. **Sodium perborate:** It releases hydrogen peroxide and sodium metaborate. It is combined with hydrogen peroxide (synergistic effect) for internal bleaching (teeth is brightened from the inside—carried out in devitalised teeth).
4. **Calcium peroxide:** It reacts with acid to release hydrogen peroxide. Toothpaste containing calcium peroxide is available.

Adverse effects: Tooth sensitivity is a common adverse effect following use of peroxide. It is due to penetration of peroxide through the enamel into the pulp. It is usually common in those with a history of tooth sensitivity, use of high concentration or frequent use of peroxide. It subsides after treatment is stopped. Sensitivity depends on the concentration of peroxide and the duration for which it is in contact with the teeth. Desensitising agents like potassium nitrate and fluorides can be used to manage tooth sensitivity.

Peroxides can alter the calcium and phosphorus content of dental hard tissues, resulting in a decrease in microhardness of enamel. They can affect the soft tissues and cause gingival irritation.

They also affect restorative materials. Following treatment of teeth with bleaching agent, there is a decrease in the enamel composite resin bond strength. They can alter the colour of filling materials resulting in mismatch of colour of teeth with filling material.

Those who are allergic to peroxides should not use them.

Discolouration of teeth could be a manifestation of undiagnosed underlying disease. Unsupervised use of these agents could mask the underlying disease.

There have been concerns of carcinogenicity following use of hydrogen peroxide; but it has not been substantiated so far.

Dentifrices containing nonbleaching whiteners are available. Nonbleaching whiteners remove surface stains by physical or chemical action. They include:

- **Abrasives**, e.g. small particles of calcium carbonate, sodium bicarbonate and silica, which can mechanically remove stains from the surface of the teeth. Some abrasives can damage the dentine.
- **Enzymes**, e.g. papain—a protease that hydrolyses peptide bonds.
- **Dimethicone** makes the surface of the teeth smooth and prevents stains.

Whitening products are available as gels, toothpaste, mouthrinse, strips and chewing gum.

OBTUNDENTS

Agents that diminish or abolish dentine sensitivity are obtundents.

An ideal obtundent should be:

- nonirritating to the pulp.
- rapid acting.
- easy to apply.
- should not stain the teeth.

Mechanism of action: Obtundents act by

- a. precipitating proteins within dentinal tubules, e.g. silver nitrate, zinc chloride, ethyl alcohol, paraformaldehyde.
- b. paralysing sensory nerve ending, e.g. phenol, camphor, menthol, thymol, etc.

Commonly used obtundents are:

1. **Zinc chloride:** It is an astringent and acts mainly by precipitating proteins in the dentine. It does not stain the teeth.
2. **Silver nitrate:** It precipitates proteins but stains the teeth black.
3. **Ethyl alcohol (70%):** It acts by precipitating proteins. It is nonstaining.
4. **Thymol, camphor and menthol:** They are volatile oils used in combination and act rapidly. They cause initial stimulation and later paralyse the sensory nerve endings.
5. **Clove oil:** It initially stimulates and then paralyses the sensory nerve endings. It may stain the teeth. Eugenol is the main constituent of essential oil obtained from cloves.
6. **Phenol:** It acts by paralysing sensory nerve endings. It acts rapidly and does not stain healthy dentine.
7. **Paraformaldehyde:** It liberates formaldehyde, which precipitates proteins. It is slow-acting. It may penetrate the pulp and cause inflammation.

Uses: Obtundents are used to make excavations painless. They are also used to reduce pain in alveolar osteitis—a gauze containing eugenol (clove oil) along with lignocaine is packed into the affected socket; pain is relieved within minutes.

Disadvantage: Irritant obtundents may shrink the pulp.

MUMMIFYING AGENTS

Agents used to harden and dry the soft tissues of the pulp and root canal. They have antiseptic and astringent properties. Commonly used mummifying agents are:

1. **Tannic acid:** It is an astringent and precipitates proteins. The tissues are hardened and become resistant to bacterial infection. It may be used alone or in combination with iodoform or eugenol and glycerine.
2. **Iodoform:** It has antiseptic and weak local anaesthetic property. It decomposes to liberate iodine. It is used as a paste in combination with tannic acid, glycerine and eugenol.
3. **Liquid formaldehyde:** It is an irritant, so it is not used alone. It can cause necrosis of oral tissues. It is used in combination with zinc oxide, thymol, local anaesthetic and glycerine as a paste.
4. **Paraformaldehyde:** It acts by liberating formaldehyde. It is used as a paste in combination with zinc oxide, zinc sulphate and glycerine.
5. **Cresol:** It is used in combination with thymol and zinc oxide as a paste.

Mummifying agents are used when the devitalised pulp and contents of root canal cannot be removed.

MOUTHWASHES (MOUTHRINSES)

A mouthwash is an aqueous solution used to rinse the oral cavity and maintain oral hygiene. Ideal properties of a mouthrinse include low cost, low toxicity, palatability, adequate penetration into plaque, adequate retention at the site of disease, entry into less-accessible areas, stable on storage and effective antibacterial activity. Cosmetic mouthwash may temporarily suppress bad breath and refresh the mouth with a pleasant taste. Therapeutic mouthwash can help reduce plaque, gingivitis, caries and bad breath.

Mouthwash contain antiseptics (phenolic compounds, bis-guanides, quaternary ammonium compounds, triclosan, halogens, oxygenating agents), astringents, antiplaque, antitartar, anticaries, desensitising agents, sweeteners, flavouring, colouring agents, detergents, odour neutralisers, etc.

Bis-guanide: Chlorhexidine gluconate is a widely used oral product. It is a cationic bis-guanide that has antimicrobial effect. It decreases pellicle formation and colonisation of enamel by bacteria. It can reduce plaque and gingivitis. It has good substantivity. Adverse effects include unpleasant taste, staining of teeth and restorative materials, calculus deposition, mucosal irritation and taste disturbances. Its efficacy is decreased by sodium lauryl sulphate; hence it should be used 30 min to 2 h after use of toothpaste.

Essential oils: Phenolic compounds containing essential oils like thymol, eucalyptol and menthol kill microorganisms by damaging their cell membrane and inhibiting their enzymes. They scavenge free radicals and also slow down maturation of plaque. They are useful for prevention of plaque, gingivitis and halitosis. Mouthwashes containing essential oils have been used as an adjunct to brushing and flossing to prevent and control plaque formation and gingivitis. Mouthwashes having essential oils contain ethanol. They should not be used in patients with xerostomia or oral mucosal disease because ethanol can cause mucosal irritation and dryness.

Quaternary ammonium compounds: For example, cetylpyridinium chloride, domiphen bromide. Cetylpyridinium chloride is a cationic agent that binds to and disrupts the bacterial cell membrane. It has been shown to reduce plaque but is less effective and has a lower substantivity than chlorhexidine. Adverse effects include staining of teeth and formation of calculus.

Germicide: Triclosan is a broad-spectrum antibacterial agent that acts by disrupting the microbial cell membrane. It inhibits cyclooxygenase and lipoxygenase to produce antiinflammatory effect. It is used in combination with a polymer to improve its antiplaque activity and surface retention.

Oxygenating agents: For example, hydrogen peroxide, sodium perborate. They are broad-spectrum antimicrobials. Hydrogen peroxide is a strong oxidising agent. Preparations containing sodium perborate are available; it reacts with water to produce hydrogen peroxide and borate. They liberate oxygen, which removes light stains and kills anaerobes. They have been shown to reduce gingivitis. They can be used for stain removal and prior to prosthodontic treatment to decrease gingival inflammation.

Povidone-iodine: It is a broad-spectrum antimicrobial agent—active against bacteria, fungi, protozoa and viruses. It can reduce plaque and gingivitis. It is useful as an adjunct with brushing for prevention of plaque formation. It also reduces severity of radiation-induced mucositis.

Fluorides: For example, sodium fluoride, stannous fluoride or acidulated phosphate fluoride. They promote re-mineralization and make the enamel resistant to acid attack. They are prescribed for patients who are at high risk of dental caries. Fluoride mouthwashes are avoided in children less than 6 years of age, as the risk of ingestion is high.

Alcohol: Ethyl alcohol is used in mouthwash as antiseptic, preservative and solvent. Alcohol-free mouthwashes are available. High concentration of alcohol can cause mucosal irritation, ulceration and pain.

Detergents: For example, sodium lauryl sulphate, sodium lauryl sarcosinate. They reduce the surface tension in the oral cavity, thus, allowing other ingredients of mouthwash to come in contact with the teeth easily. They have antiplaque effect. By their foaming action, they help to remove food debris from the oral cavity. Sodium lauryl sulphate is a commonly used detergent. Its disadvantage has been the occurrence of aphthous ulcers in some patients. Sodium lauryl sarcosinate is another detergent that is less irritant to the mucosa. Detergent-free mouthwashes are available.

Astringents: For example, zinc chloride, zinc sulphate, tannic acid. They precipitate proteins in the cells to form a protective coat. They are useful in ulcerative gingivitis, aphthous ulcers and chronic alveolar abscess.

Antitartar agent: Zinc compounds prevent buildup of tartar.

Flavouring agents: They are menthol, eucalyptol, peppermint, etc. They improve the flavour of mouthwash, mask the unpleasant taste of ingredients like sodium lauryl sulphate and provide a sense of freshness inside the mouth.

Sweeteners: Saccharin, sucralose, sorbitol, xylitol are used to impart a mild sweet taste to the mouthwash.

Preservatives: Sodium benzoate and methylparaben are used as preservatives to prevent the growth of microorganisms.

Colouring agents are also used in mouthwashes to improve the appearance.

Others:

Benzydamine hydrochloride: It has analgesic, antiinflammatory, antimicrobial and anaesthetic properties. It acts by inhibiting prostaglandin synthesis and decreasing cytokine production by macrophages. It has been shown to reduce severity and duration of radiation-induced mucositis for which it is recommended.

Antibacterial peroxidase: Mouthwashes may contain enzymes that act against bacterial peroxidases. The enzymes include glucose oxidase, lactoperoxidase and lysozyme. They can be used for gingivitis and halitosis. These mouthwashes have a low pH, which may result in dental erosion following prolonged use.

Sodium bicarbonate: It is useful in patients with oral ulcers, as it does not irritate the oral mucosa. It increases the pH of saliva and suppresses the growth of *S. mutans*. Anaerobic bacteria produce volatile sulphur compounds, which results in bad breath. Sodium bicarbonate helps to neutralise and mask bad odours.

■ Uses of Mouthwash

- To reduce plaque formation.
- In gingivitis, dental caries and stomatitis.
- To relieve soreness of teeth and gums following flossing and use of dentures.
- To reduce bad breath (halitosis).
- To keep the oral cavity moist in xerostomia, as lack of saliva increases the risk of tooth decay.
- To treat oral burns, aphthous ulcers, alveolar osteitis (dry socket) and mucositis following cancer chemotherapy and radiotherapy.
- To maintain oral hygiene in persons who are unable to brush adequately owing to their physical disability.

The mouthwash should be swished in the mouth for about 1 min twice/thrice daily and spit-out. It should not be swallowed. Patient should be advised not to eat, drink or rinse the mouth for at least 30 min after using a mouthwash.

■ Side Effects

Mouthwash may contain ingredients that cause mucosal irritation and ulcers. They can cause taste disturbances, staining of teeth and restorative materials. Allergy can occur to ingredients of mouthwash. Swallowing of fluoride-containing mouthwash can lead to fluoride toxicity. Too much ingestion of alcohol-containing mouthwash can be dangerous in children. There has been concern about the possible risk of oral cancer on long-term use of mouthwash due to alcohol present in it. Excessive use of mouthwash can damage the normal flora in the oral cavity.

CHELATING AGENTS

Chelating agents combine with metallic ions and form ring structures that are water-soluble complexes and are rapidly excreted from the body. These agents are used in heavy metal poisoning. Various chelating agents are:

1. Dimercaprol [British Anti-Lewisite (BAL)].
2. Disodium edetate (Na_2 EDTA).
3. Calcium disodium edetate (CaNa_2 EDTA).
4. d-Penicillamine.
5. Desferrioxamine.
6. Deferiprone.

An **ideal chelating agent** should:

- be highly water soluble.
- neither metabolized nor stored in the body.
- be readily excreted in urine.
- have low affinity for calcium.

■ Dimercaprol

It was developed as an antidote for arsenic containing war gases such as lewisite during World War II. The sulphhydryl (SH) groups of dimercaprol (BAL) react with metals to form a chelating complex. It is administered intramuscularly. It is used in arsenic, mercury, gold and bismuth poisoning, and also as an adjuvant in copper and lead poisoning. Succimer [2,3-dimercaptosuccinic acid (DMSA)] and unithiol are analogues of dimercaprol. They are effective orally, less toxic and are used in the treatment of arsenic, mercury and lead poisoning.

Adverse effects: Nausea, vomiting, headache, fever, salivation, rise in BP, tachycardia and pain at the site of injection.

■ Disodium Edetate

On intravenous (i.v.) administration, it chelates calcium and causes hypocalcaemic tetany. Hence, it is not preferred in lead poisoning. It can be used in the treatment of hypercalcaemia and as an anticoagulant *in vitro*.

■ Calcium Disodium Edetate

It is preferred in the treatment of lead poisoning as it does not deplete calcium. It can also be used in zinc, copper and manganese poisoning. Calcium in the chelating agent is exchanged with the heavy metal. It is administered intravenously or intramuscularly. In dentistry:

- EDTA forms a complex with calcium in the dentin; hence, manipulation of dentin by instrumentation becomes easier.
- It is used as a final rinse for cleaning of root canal to remove smear layer from canal wall.

Adverse effects: Calcium EDTA is toxic to the kidney. The other side effects are fatigue, fever, myalgia, headache, nausea, vomiting, etc.

■ D-Penicillamine

It is a degradation product of penicillin; hence it may have cross-reactivity with penicillins. It is effective in copper, mercury, zinc and lead poisoning. Other uses are Wilson's disease, scleroderma, cystinuria and rheumatoid arthritis.

Wilson disease is characterized by the accumulation of copper in many tissues and organs due to a decrease in serum ceruloplasmin. D-Penicillamine is used in Wilson's disease as it chelates copper and promotes its excretion. Lifelong therapy is required.

Adverse effects: Skin rashes, pruritus, urticaria, pemphigoid lesions, pyrexia, etc.

■ Desferrioxamine (Deferoxamine)

It is an iron-chelating agent. It is not effective orally, as it is poorly absorbed from GI tract. It is administered parenterally (i.m./i.v.). It chelates iron from haemosiderin and ferritin but does not affect iron in haemoglobin or cytochrome. It is used intramuscularly for chronic iron poisoning (thalassaemia). Intravenous desferrioxamine is the drug of choice for acute iron poisoning. It can be used intravenously to chelate aluminum during dialysis.

Adverse effects include allergic reactions such as skin rashes, itching, flushing and anaphylaxis. Other adverse effects are diarrhoea, dysuria, hypotension and tachycardia. It is contraindicated in pregnancy and renal insufficiency. It can cause neurotoxicity on long-term use.

■ Deferiprone

It is an orally effective iron-chelating agent. It is used in the treatment of transfusion siderosis in thalassaemia and also in acute iron poisoning.

Adverse effects: They are anorexia, nausea, vomiting, joint pain and rarely agranulocytosis.

Key Point for Dentists

- ↳ EDTA is useful for root canal treatment.

ANTISEPTICS AND DISINFECTANTS

1. **Sterilization:** It is the destruction of all microorganisms including spores.

2. **Germicide:** It is an agent used to kill microorganisms but not spores. It includes disinfectants and antiseptics.
3. **Disinfectant:** It is an agent used to eliminate microorganisms on inanimate objects.
4. **Antiseptic:** It is an agent used to eliminate microorganisms on living tissues.

Classification

1. Phenols and related agents: Phenol, cresol, chlorhexidine, resorcinol, hexachlorophene and chloroxylenol.
2. Alcohols: Ethyl alcohol and isopropyl alcohol.
3. Aldehydes: Formaldehyde and glutaraldehyde.
4. Oxidizing agents: Hydrogen peroxide and potassium permanganate.
5. Halogens and halogen-releasing agents: Chlorine, sodium hypochlorite, iodine and iodophors
6. Acids: Benzoic acid and boric acid.
7. Metallic salts: Silver nitrate and zinc oxide.
8. Dyes: Gentian violet, brilliant green and methylene blue.
9. Surface-active agents (**detergents**): Common soaps, cetrimide, benzalkonium chloride and cetylpyridinium chloride.
10. Gases: Ethylene oxide and β -propiolactone.
11. Miscellaneous: Nitrofurazone.

Phenols
Halogens
Alcohols, Aldehydes
Surface-active agents
Metallic salts, Miscellaneous
Acids
Gases
Oxidizing agents
Dyes

Note: Mnemonic for classification: 'PHARMA GOD'.

An ideal disinfectant or antiseptic

1. It should be effective against all pathogens, like bacteria, viruses, fungi, protozoa, including spores.
2. It should not delay wound healing.
3. It should be effective in the presence of organic matter like blood, pus and excreta.
4. It should be stable.
5. It should not be toxic if absorbed or cause irritation on topical application.
6. It should not corrode metals.

■ Phenols and Related Agents

They are protoplasmic poisons. They denature bacterial proteins and disrupt the cell wall. Their efficacy is reduced in the presence of organic matter.

1. **Phenol (carbolic acid)**
 - Rarely used as antiseptic, as it is corrosive and can penetrate intact skin.
 - Used to disinfect sputum, pus, excreta and discarded cultures.
 - Accidental or suicidal ingestion can cause corrosion of gastrointestinal tract (GIT), convulsions, hypothermia and collapse. Treatment is symptomatic.
2. **Cresol (methylphenol)**
 - More active and safer than phenol.
 - Used to disinfect utensils, excreta and infected glassware.
3. **Lysol (soapy emulsion of cresol)**
 - Commonly used to disinfect the floor in hospitals and houses.
 - As antiseptic to wash hands.

4. **Chloroxylonol**
 - Active ingredient of dettol.
 - Less toxic than phenol.
 - Used to disinfect surgical instruments and as an antiseptic for skin before any surgery.
5. **Resorcinol**
 - Nonstaining and less toxic.
 - It has keratolytic and antipruritic properties; hence it is used in eczema, ringworm and seborrhoeic dermatitis.
6. **Hexachlorophene**
 - Chlorinated phenol.
 - Greater than 2% solution is not used.
 - Used as an antiseptic for skin before surgery, furunculosis and seborrhoeic dermatitis.
7. **Chlorhexidine**
 - Used as a mouthwash and as an antiseptic for skin prior to surgery.
 - Chlorhexidine mouthwash enhances wound healing, if used before dental procedures. It is used as an antiplaque and antigingivitis agent.
 - Taste alteration and staining of oral cavity are the common side effects.

■ Alcohols

They act by denaturing bacterial proteins and precipitating them.

1. **Ethyl alcohol**
 - 70% ethyl alcohol is used as an antiseptic on skin before giving injections and surgical procedures. Its antiseptic efficacy decreases above 90%.
 - It should not be used on open wounds, mucosa, ulcers and scrotum, as it is highly irritant.
 - It is not useful for disinfecting instruments, as it promotes rusting.
2. **Isopropyl alcohol**
 - More potent.
 - 68–72% is used as an antiseptic.
 - Can be used to disinfect clinical thermometers.

■ Aldehydes

They act by denaturing the proteins. They are protoplasmic poisons.

1. **Formaldehyde**
 - 40% solution is called formalin.
 - Formaldehyde solution is used for disinfection of sputum, removal of warts on palms and soles, to treat hyperhidrosis, and preservation of anatomical and pathological specimens.
 - Formaldehyde gas is used for fumigation of wards and operation theatres, and rarely for sterilization of heat sensitive instruments and gloves.
 - In dentistry, it is used to harden the residual pulp tissue.
2. **Glutaraldehyde**
 - Preferred to formaldehyde to sterilize surgical instruments, plastic endotracheal tubes, face masks, corrugated rubber tubes, endoscopes, respirators and thermometers, etc.
 - 2% solution is used to treat hyperhidrosis of palms and soles.

■ Oxidizing Agents

They act by releasing nascent oxygen, which oxidizes the bacterial protoplasm.

1. Hydrogen peroxide

- Colourless liquid.
- Effervescence is seen when applied to tissues due to presence of enzyme catalase, which degrades hydrogen peroxide.
- Used for cleaning wounds and abscess cavities, removal of slough and ear wax.
- Can also be used to disinfect contact lenses, plastic implants and surgical prostheses.
- In dentistry, it is used as a mouthwash and to disinfect septic sockets and root canals.

2. Potassium permanganate

- Dark purple crystals that are water soluble.
- Condy lotion is 1:4000–1:10,000 solution of potassium permanganate. It is used for gargling.
- 5% solution is used as a styptic.
- 1% solution is used for fungal infections—athletes foot.
- Used topically for snake and scorpion bites, and for stomach wash in alkaloid poisoning.
- Can also be used for purification of well water.
- Concentrated solution can cause burns and blisters on topical application.
- Not used to disinfect surgical instruments, as it promotes rusting.

■ Halogens

They are oxidizing agents.

1. Chlorine: It is used for disinfection of water. Some of its preparations are:

- **Chloramines:** They act by releasing chlorine. They can be used as mouthwash and for dressing of wounds.
- **Chlorinated lime** (bleaching powder)
 - i. Acts by releasing chlorine.
 - ii. Used to disinfect drinking water and toilets.
 - iii. Disadvantage is that it is highly unstable and loses its activity on storage.

2. Sodium hypochlorite

- Used as a root canal disinfectant.
- It is cheaper; but it needs to be freshly prepared and has corrosive effect on metals.

3. Iodine

- It has the property of oxidizing the protoplasm of microbes.
- Its antiseptic efficacy decreases in the presence of organic matter.
- Hypersensitivity reactions can occur with iodine.
- Its preparations are:
 - i. **Tincture iodine (2% iodine in alcohol)**
 - Used as an antiseptic on skin for wounds and prior to surgery.
 - It stains the skin.
 - ii. **Mandl's paint**
 - It contains iodine in potassium iodide and glycerine.
 - Used topically in tonsillitis and pharyngitis.

- iii. **Lugol's iodine** (see p. 265)
 - Contains 5% iodine in 10% solution of potassium iodide.
 - Used in thyrotoxicosis.
- iv. **Iodophors**
 - Act by releasing iodine, e.g. povidone iodine.
 - Nonirritant and does not stain the skin.
 - Used in burns, boils, prior to surgery, disinfection of instruments and endoscopes.
 - 1% solution can be used as a mouth rinse for gingivitis and before dental procedures.

■ Acids

Antiseptic activity is mainly due to their antibacterial activity.

1. **Boric acid and sodium borate (Borax)**
 - Fungistatic and bacteriostatic.
 - 2–4% solution is used as mouthwash.
 - 30% paint for stomatitis and glossitis.
 - 10% ointment for cuts and abrasions.
 - It is a component of prickly heat powder.
 - Systemic absorption can cause abdominal pain, diarrhoea, vomiting, visual disturbances and kidney damage.
2. **Benzoic acid**
 - Antibacterial and antifungal.
 - Whitfield's ointment (6% benzoic acid + 3% salicylic acid) is used for ringworm infections.

■ Metallic Salts

1. **Zinc sulphate**
 - It has antiseptic and astringent properties.
 - Used topically for conjunctivitis, ulcers and acne.
 - It decreases sweating, hence used as a component in deodorants.
 - Zinc salts are one of the components in calamine lotion, which is used in urticaria and eczema as an antiseptic and antipruritic agent.
2. **Silver nitrate**
 - It is an astringent and antiseptic.
 - 1% eye drops is used for prophylaxis of conjunctivitis.
 - It can also be used as an antiseptic on burns, for removal of warts and oral ulcers.
3. **Silver sulphadiazine:** It is very effective against *Pseudomonas*, hence used topically for preventing infection on burnt surfaces.

■ Dyes

They are used topically as antiseptics. They stain the skin on application.

- Gentian violet and brilliant green are useful in gingivitis, oral thrush, bed sores, chronic ulcers, burns, etc.
- Methylene blue is used in cyanide poisoning.

■ Surface Active Agents (Surfactants)

They act by lowering the surface tension of solutions. There are two types of surfactants:

1. **Anionic surfactants:** They are common soaps. Soaps contain fatty acids with alkali (sodium or potassium hydroxide).
2. **Cationic surfactants:** They are benzalkonium chloride, cetrimide and cetylpyridinium chloride.
 - Most commonly used antiseptics.
 - Benzalkonium chloride is used as an antiseptic on skin prior to surgery and to store sterilized instruments.
 - Cetrimide (cetavlon) is used as a preservative for eye drops and to disinfect instruments.
 - Savlon (cetrimide + chlorhexidine) is used to disinfect thermometers.

■ Gases

Ethylene oxide, formaldehyde and β -propiolactone gases are used for sterilization.

1. **Ethylene oxide**
 - Acts by alkylating the proteins and nucleic acids.
 - Highly inflammable and explosive.
 - Used for sterilization of heart–lung machines, plastic equipment, sutures, dental equipment and cardiac catheters.
 - Not used for fumigation, as it is explosive.
2. **Formaldehyde:** See p. 384.

■ Miscellaneous

Nitrofurazone has bactericidal action, but no action on fungi. It is used topically for burns and ulcers.

Key Points for Dentists

- Use gloves while handling disinfectants.
- Chlorhexidine is available as solution for mouth rinse.

VITAMINS

They are organic substances that are required in small quantities to meet the metabolic demands of the body. Most of them are supplied through diet. They are converted in the body to coenzymes, which participate in metabolic reactions. Usually, a well-balanced diet provides required amount of vitamins to the body. Vitamins A, D, E and K are fat-soluble vitamins (Table 13.1). Water-soluble vitamins include vitamin B complex and vitamin C (Table 13.2).

Table 13.1 Fat-soluble Vitamins

Vitamin	Source	Daily Requirement (adult)	Functions	Deficiency (Signs and Symptoms)	Uses
Vitamin A (retinol)	Leafy vegetables (spinach, cabbage, etc.), carrot, pumpkin, mango, orange, papaya, fish liver oils, liver, egg, butter, cheese, milk, etc.	4000 IU	<ul style="list-style-type: none"> Necessary for the synthesis of retinal pigments, which are required for dark adaptation (vision in dim light) Maintains the integrity of epithelial cells Stimulates cell-mediated immunity and supports skeletal growth 	<ul style="list-style-type: none"> Night blindness Dryness of conjunctiva and cornea Defective bone and teeth formation Xerostomia Dryness of skin (phrynoderma) with papular eruptions 	<ul style="list-style-type: none"> Prophylaxis: 4000 IU/day PO Treatment: 50,000–1,00,000 IU PO for 3 days
Vitamin D (see pp. 291–293)	Fish liver oils, dairy products and synthesized in the skin on exposure to sunlight	100–200 IU	Increases plasma calcium and phosphate by acting on GIT, kidney and bone	<ul style="list-style-type: none"> Rickets in children and osteomalacia in adults Delayed dentition Increased incidence of caries 	<ul style="list-style-type: none"> Prophylaxis: 400 IU/day Treatment: 4000 IU/day
Vitamin E (α -tocopherol)	Wheat germ oil, nuts, cereals, green leaves, etc.	5–15 mg	As an antioxidant	Affects fertility; degenerative changes in skeletal muscle, CNS and myocardium	<ul style="list-style-type: none"> To prevent and treat cancer chemotherapy-induced oral mucositis Muscle cramps Fibrocystic breast disease
Vitamin K (see p. 243)	Spinach, cabbage, cauliflower, tomato, butter, meat, milk, liver, etc.	70–140 mcg	Helps in the synthesis of clotting factors II, VII, IX and X	<ul style="list-style-type: none"> Increased tendency to bleed Gingival haemorrhage 	<ul style="list-style-type: none"> Prevention and treatment of bleeding associated with vitamin K deficiency. Routinely given to neonates Warfarin toxicity

Table 13.2 Water-soluble Vitamins

Vitamin	Source	Daily Requirement (adult)	Functions	Deficiency (Signs and Symptoms)	Uses
Vitamin B ₁ (thiamine)	Wheat, cereals, pulses, nuts, meat, milk, fish, egg, vegetables and fruits	1–2 mg	<ul style="list-style-type: none"> Acts as a coenzyme for carbohydrate metabolism Essential for transmission of nerve impulses 	<ul style="list-style-type: none"> Dry Beri Beri (affects nervous system—peripheral neuritis, tingling, numbness, muscular weakness and atrophy) Wet Beri Beri (affects the heart—tachycardia, palpitation, dyspnoea and cardiac failure) 	<ul style="list-style-type: none"> Required for patients on regular haemodialysis Chronic alcoholics
Vitamin B ₂ (riboflavin)	Liver, meat, egg, milk, cereals and pulses	2–3 mg	Acts as a coenzyme in oxidation–reduction reaction	Glossitis, cheilosis, stomatitis	Prophylaxis and treatment of vitamin B ₂ deficiency
Vitamin B ₃ (niacin)	Liver, meat, fish, egg, ground-nuts, etc.	15–20 mg	Necessary for carbohydrate and protein metabolism	Diarrhoea, dermatitis and dementia (3D)—pellagra mucositis, cheilosis, stomatitis, glossitis	<ul style="list-style-type: none"> Prophylaxis and treatment of pellagra As a hypolipidaemic agent
Vitamin B ₆ (pyridoxine)	Bean, milk, liver, fish, egg, cereals, vegetables, etc.	2 mg	Involved in carbohydrate, fat and protein metabolism	Peripheral neuritis, anaemia and convulsions Angular cheilosis, glossitis, stomatitis	<ul style="list-style-type: none"> Prophylaxis and treatment of vitamin B₆ deficiency Along with isoniazid (INH) to prevent/treat peripheral neuropathy Along with B₁ and B₁₂ to treat neuropathies

(Contd...)

Table 13.2 (Contd...)

Vitamin	Source	Daily Requirement (adult)	Functions	Deficiency (Signs and Symptoms)	Uses
Vitamin B ₁₂ (see p. 255–256)	Synthesized in the gut by bacteria, meat, liver, egg, fish, etc.	1 mcg	Along with folic acid, it is essential for DNA synthesis	Megaloblastic anaemia, peripheral neuritis and pernicious anaemia Stomatitis, glossitis, halitosis, xerostomia, aphthous ulcers	<ul style="list-style-type: none"> • Megaloblastic anaemia due to B₁₂ deficiency • Pernicious anaemia (by i.m. route) along with B₁ and B₆ for neuropathies
Folic acid (see p. 256–257)	Fresh green leafy vegetables, liver, fruits, milk, egg, dairy products, etc.	500–800 mcg	Its active form—tetrahydrofolate—is essential for biosynthesis of amino acids, purines, pyrimidines, DNA and therefore in cell division	Megaloblastic anaemia, glossitis, gingivitis	<ul style="list-style-type: none"> • Megaloblastic anaemia • Prophylaxis in pregnancy • Methotrexate toxicity
Vitamin C (ascorbic acid)	Citrus fruits, vegetables, tomato, leafy vegetables, germinating pulses, breast milk, etc.	30–50 mg	<ul style="list-style-type: none"> • Formation of collagen, bone, teeth, capillaries and healing of wounds • Formation of haemoglobin and maturation of RBCs 	Scurvy characterized by fatigue, weakness, swollen spongy bleeding gums, loose teeth, resorbed dentine, conjunctiva and subperiosteal haemorrhages, delayed wound healing, osteoporosis and anaemia	<ul style="list-style-type: none"> • Prophylaxis: 50–100 mg/day • Treatment: 500–1500 mg/day • May be used to help healing of wounds and fractures • To acidify urine in alkaline drug poisoning • Promote absorption of iron from the gut • Can be used in common cold and cancer: of doubtful value

Key Points for Dentists

- Vitamin A should be avoided in pregnant and lactating women.
- Vitamin C deficiency can cause bleeding gums, poor wound healing and defective teeth formation.
- Vitamins A, D, E and K can cause hypervitaminosis, as they are stored in the body.
- Niacin causes itching and flushing on oral administration—can be prevented with aspirin.

DRUG TREATMENT OF MEDICAL EMERGENCIES

Drug treatment of medical emergencies is listed in Table 13.3. For details, see respective chapters.

Table 13.3 Drug Treatment of Medical Emergencies

Emergency Condition	Drug Treatment
1. Anaphylactic shock	Inj. Adrenaline (1:1000) 0.3–0.5 mL i.m. Inj. Hydrocortisone 200 mg i.v. Inj. Diphenhydramine 25–50 mg i.v./i.m.
2. Hypoglycaemia	If the patient is conscious, oral glucose or fruit juice is given. If hypoglycaemia is severe (patient is unconscious), 50 mL of 50% dextrose is injected intravenously.
3. Adrenal crisis	Inj. Hydrocortisone 200 mg i.v. Intravenous normal saline with 5% glucose. Correct fluid and electrolyte imbalance.
4. Acute attack of angina/myocardial infarction (MI)	Tab. Nitroglycerin 0.5 mg sublingually. If the pain is relieved, spit out the tablet. If the pain is not relieved, the tablet can be repeated after 5 min, but not more than three tablets in 15 min. If pain is not relieved, it could be MI. Give tablet aspirin 325 mg orally, oxygen by face mask, then refer the patient to cardiologist.
5. Status asthmaticus (acute severe asthma)	Humidified oxygen by mask. Salbutamol 5–10 mg + ipratropium bromide 0.5 mg continuous nebulization. Inj. Hydrocortisone hemisuccinate 200 mg i.v. stat and 100 mg 6 hourly till the attack subsides. Cap. Amoxicillin 500 mg PO TDS.
6. Acute bronchial asthma	Salbutamol metered dose inhaler (MDI) 100 mcg/puff: 1–2 puffs stat and as and when required (not more than 8 puffs/day).
7. Seizures (epileptic/drug induced)	Inj. Diazepam 5–10 mg i.v. slowly; repeat the dose, if necessary. Or Inj. Lorazepam 0.1 mg/kg i.v. slowly.
8. Tetany	Inject 10–20 mL of 10% calcium gluconate slow intravenously.
9. Fainting	Aromatic ammonia vapouroles held near the nostrils
10. Hypertensive crisis	Inj. Sodium nitroprusside 0.25–1.5 mcg/kg/min i.v. infusion in 5% dextrose
11. Thyrotoxic crisis	Tab. Propylthiouracil 150–300 mg PO q6h, Ipodate sodium 0.5 g PO daily, Inj. Propranolol 0.5–2 mg i.v. slowly q4h, Inj. Hydrocortisone 100 mg i.v. q8h.
12. Severe bleeding following dental procedures	<ul style="list-style-type: none"> • Application of pressure at the site of bleeding • Ice pack • Topical haemocoagulase* solution – applied with a cotton swab. or • Cotton pad soaked in 0.1% adrenaline solution, placed on the bleeding site • Inj. Tranexamic acid 500 mg slow i.v.

*Haemocoagulase enzyme complex is isolated from the venom of *Bothrops atrox* (viper). It promotes coagulation by converting fibrinogen to fibrin. It can also shorten the bleeding and clotting time, thereby reducing blood loss. It is available for topical, intravenous, intramuscular and subcutaneous administration.

DENTAL TRAY (EMERGENCY DRUG KIT) FOR DENTISTS

For route and dose see Table 13.3. For more details see respective chapters.

Drug	Uses
Inj. Adrenaline (1:1000)	Anaphylactic shock
Inj. Hydrocortisone	Anaphylactic shock, adrenal crisis, acute severe asthma
50% Dextrose	Hypoglycaemia (If the patient is unconscious)
Inj. Diazepam	Seizures (epileptic/drug induced)
Inj. Diphenhydramine	Allergic reactions
Nitroglycerin (sublingual)	Acute angina attack, myocardial infarction (MI)
Salbutamol metered dose inhaler (MDI)	Acute bronchial asthma
Inj. Morphine	Myocardial infarction
Tab. aspirin (low dose)	Myocardial infarction, angina
Haemocoagulase*	To control bleeding following dental procedures
10% Calcium gluconate	Tetany
Aromatic ammonia vapouroles	Fainting attacks
Polythene/paper bag	Hyperventilation
Oxygen	Essential in every dental clinic

*Haemocoagulase enzyme complex is isolated from the venom of *Bothrops atrox* (viper). It promotes coagulation by converting fibrinogen to fibrin. It can also shorten the bleeding and clotting time, thereby reducing blood loss. It is available for topical, intravenous, intramuscular and subcutaneous administration.

Appendix

Commonly Used Abbreviations

Abbreviations	Meaning
Tab.	Tablet
Cap.	Capsule
mg	Milligram
mcg	Microgram
IU	International unit
PO	By mouth
PR	Per rectum
OD	Once a day
QD	Once daily
BD	Twice a day
TDS	Three times a day
QID	Four times a day
q4h	Every four hourly
HS	At bed time
SOS	As and when required
Stat	At once

Commonly Prescribed Drugs

■ Antihypertensive Drugs

Tab. hydrochlorothiazide, 12.5–25 mg PO OD.

Tab. atenolol, 25–100 mg PO OD.

Tab. lisinopril, 5–40 mg PO OD.

Tab. amlodipine, 2.5–10 mg PO OD.

■ Drugs Used in Congestive Cardiac Failure

Tab. furosemide, 20–80 mg PO OD.
 Tab. lisinopril, 2.5–20 mg PO OD.
 Tab. ramipril, 1.25–5 mg PO OD.
 Tab. digoxin, 0.25 mg PO OD.

■ Myocardial Infarction

Sublingual nitroglycerin (0.5 mg)—not more than 3 tablets in 15 min; for recurrent or persistent pain intravenous nitroglycerine is used.
 Tab. aspirin, 150–325 mg PO stat, then 75–150 mg OD.
 Inj. morphine, 2–4 mg i.v.; repeat the dose, if necessary
 Inj. streptokinase, 15 lac units, slow i.v. infusion over 1 h.
 Inj. heparin 5000 U, i.v. bolus followed by 750–1000 U over 1 h i.v. infusion.
 Tab. metoprolol, 12.5 mg PO BD.
 Tab. ramipril, 1.25 mg PO OD.
 Tab. atorvastatin, 10 mg PO OD.

■ Lipid-lowering Agent

Tab. atorvastatin, 10–40 mg PO at bed time.

■ Dry Cough

Syrup dextromethorphan, 10–20 mg (30 mg/5 mL) TDS.
 Or
 Linctus codeine, 15 mg PO TDS.

■ Allergic Cough

Tab. chlorpheniramine maleate, 2–4 mg PO TDS.
 Or
 Elixir promethazine, 5 mg/5 mL PO TDS.

■ Acute Bronchial Asthma

Salbutamol MDI* 100 mcg/puff: 1–2 puffs stat, synchronized with inspiration during an attack, then as and when required (not more than 8 puffs/day).
 Or
 Terbutaline MDI, 250 mcg/puff: 1–2 puffs stat synchronized with inspiration, then as and when required.

*MDI: Metered dose inhaler.

■ Generalized Tonic–Clonic Seizures (Grand mal Epilepsy)

Tab. carbamazepine, 200–400 mg PO BD–QID.

Or

Tab. phenytoin, 200–400 mg PO OD.

Or

Tab. valproate, 200–400 mg PO TDS.

■ Status Epilepticus

Inj. lorazepam, 0.1 mg/kg i.v. slowly.

Or

Inj. diazepam, 5–10 mg i.v. slowly; repeat the dose, if necessary, after 10 min.

Inj. phenytoin, 20 mg/kg i.v. slowly.

■ Insomnia

Tab. diazepam, 5–10 mg PO HS.

Or

Tab. flurazepam, 15–30 mg PO HS.

Or

Tab. zolpidem, 10 mg PO HS.

■ Anxiety Disorders

Tab. diazepam, 5–10 mg PO TDS.

Or

Tab. alprazolam, 0.5 mg PO BD.

■ Opioid Analgesics

Tab./Syrup morphine, 30 mg PO TDS.

Inj. morphine, 10 mg i.m. or i.v.

Tab. pethidine, 300 mg PO.

Inj. pethidine, 50–100 mg i.m. or i.v.

Inj. tramadol, 100 mg i.m. or i.v.

Tab. tramadol, 100 mg PO.

■ Nonsteroidal Anti-inflammatory Drugs (NSAIDs)

Tab. aspirin (as analgesic): 2–3 g/day in four divided doses after food.

Tab. aspirin (as anti-inflammatory): 4–6 g/day in four divided doses after food.

Tab. paracetamol, 0.5–1 g PO QID.

Inj. paracetamol, 150–300 mg i.m.

Tab. ibuprofen, 400–800 mg PO TDS after food.

Tab. diclofenac, 50 mg PO BD after food.

Tab. aceclofenac, 100 mg PO BD after food.
 Inj. diclofenac, 75 mg i.m.
 Tab. piroxicam, 20 mg PO OD after food.
 Tab. indomethacin, 25 mg PO TDS after food.
 Tab. ketorolac, 10 mg PO QID.
 Inj. ketorolac, 15–30 mg i.m. or i.v. q8h.

■ Osteoarthritis

Tab. paracetamol, 500 mg PO SOS.
 Tab. ibuprofen, 400 mg PO SOS.
 Tab. diclofenac, 50 mg PO SOS.

■ Postoperative Pain

Inj. tramadol, 100 mg i.m./i.v.
 Or
 Inj. diclofenac, 75 mg i.m.
 Or
 Inj. ketorolac, 30 mg i.m. or i.v.; repeat after 6 h, if required.

■ Antiemetics

Tab. metoclopramide, 10 mg PO TDS.
 Inj. metoclopramide, 10 mg i.m.
 Tab. domperidone, 10–20 mg PO TDS.
 Tab./Inj. ondansetron, 8 mg PO/i.v.

■ Drugs Used in Peptic Ulcer

Cap. omeprazole, 20 mg PO OD.
 Cap. lansoprazole, 30 mg PO OD.
 Tab. ranitidine, 150 mg PO BD.
 Tab. famotidine, 40 mg PO HS.
 Tab. misoprostol, 200 mcg PO QID.
 Tab. sucralfate, 1 g PO QID; to be taken on an empty stomach 1 h before meals and at bedtime.

■ *Helicobacter pylori* Infection

▶ Triple-drug Therapy

Cap. lansoprazole, 30 mg PO BD+
 Tab. clarithromycin, 500 mg PO BD+ } For 14 days
 Cap. amoxicillin, 1 g PO BD.
 Cap. lansoprazole to be continued for another 6 weeks.

■ Motion Sickness

Tab. dimenhydrinate, 50 mg PO 1 h before starting journey.

Or

Tab. promethazine, 25 mg PO 1 h before starting journey.

■ Antidiarrhoeal Agent (Nonspecific)

Tab. loperamide 4 mg PO stat, followed by 2 mg after each loose stool (not more than 16 mg in 24 h).

■ Acute Functional Constipation

Tab. bisacodyl, 10 mg PO HS.

Or

Bisacodyl suppository, 10 mg PR (per rectal).

■ Iron-deficiency Anaemia

Prophylaxis

Tab. ferrous sulphate (100 mg of elemental iron) PO OD after food.

Treatment

Tab. ferrous sulphate, 200 mg (60 mg of elemental iron) PO TDS after food for 4–6 months.

Severe bleeding due to warfarin overdose

Fresh frozen plasma 10–20 mL/kg i.v.

Inj. phytonadione (vitamin K₁), 10 mg i.m. stat; repeat 5 mg of vitamin K₁, if necessary, after 4 h.

Severe bleeding due to heparin

Inj. protamine sulphate, 1 mg slow intravenously for every 100 U of heparin remaining in the patient.

■ Type-2 Diabetes Mellitus (Oral Antidiabetic Agents)

Tab. metformin, 0.5–2.5 g daily in three divided doses with food.

Tab. glibenclamide, 1.25–20 mg PO single or in two divided doses.

Tab. glipizide, 5–40 mg PO single or in two divided doses.

Tab. gliclazide, 40–320 mg PO single or in two divided doses.

Tab. glimepiride, 1–8 mg PO single dose.

■ Bacillary Dysentery

Tab. ciprofloxacin, 500 mg PO BD for 5 days.

Or

Tab. levofloxacin, 500 mg PO BD for 5 days.

■ Streptococcal Pharyngitis, Tonsillitis

Tab. amoxicillin, 500 mg PO TDS for 7–10 days.

Or

Tab. azithromycin, 250–500 mg PO OD for 5 days.

■ Pulmonary Tuberculosis

Tab. isoniazid, 300 mg.

Tab. pyridoxine, 10 mg.

Tab. rifampin, 600 mg.

Tab. pyrazinamide, 1500 mg.

Tab. ethambutol, 1000 mg.

} Daily dose of all tablets; to be taken PO half an hour before breakfast.

■ Prophylaxis of HIV Infection (Postexposure Prophylaxis)

Tab. zidovudine, 300 mg PO BD }

Tab. lamivudine, 150 mg PO BD } For 4 weeks

Tab. indinavir, 800 mg PO TDS }

■ Insomnia Due to Toothache

Tab. paracetamol, 500 mg PO stat/Tab. ibuprofen, 400 mg PO stat.

Tab. diazepam, 5 mg PO at bedtime.

■ Toothache in Patient with Peptic Ulcer

Tab. paracetamol, 500 mg PO TDS.

Or

Tab. etoricoxib, 120 mg PO OD.

+

Cap. omeprazole, 20 mg PO OD.

■ Post-extraction Pain with Swelling

Tab. ibuprofen, 400 mg PO TDS after food for 3 days.

Or

Tab. diclofenac, 50 mg PO BD after food for 3 days.

■ Bleeding after Tooth Extraction

Topical haemocoagulase solution—applied with a cotton swab

Or

A cotton swab soaked in adrenaline (1:10,000 solution) applied with pressure over the bleeding area

Or

Adrenochrome monosemicarbazone, 1–5 mg oral or i.m.

■ Hypotension Due to Local Anaesthetic

Inj. mephentermine, 15 mg i.m./slow i.v. infusion

Or

Inj. methoxamine, 3–5 mg slow i.v.

■ Acute Necrotizing Ulcerative Gingivitis (ANUG, Trench Mouth)

Tab. metronidazole, 400 mg PO TDS. }
 Tab. penicillin V, 500 mg PO TDS. } For 10 days.

■ Alveolar Abscess

Tab. metronidazole, 400 mg PO TDS for 7 days.

Cap. cefadroxil, 0.5 g PO BD/cap. amoxicillin, 500 mg PO TDS for 7 days.

Tab. ibuprofen, 400 mg PO TDS after food for 3 days.

■ Oral Candidiasis (Oral Thrush)

Clotrimazole troche, 10 mg to be allowed to dissolve in the mouth QID for 14 days.
 (Clotrimazole lotion and gel can also be used for oral candidiasis.)

Or

Nystatin oral suspension (1 lac U/mL). 4–6 mL to be swished and swallowed 4–5 times a day for 14 days.

Or

Cap. fluconazole, 200 mg PO on the first day and then 100 mg daily for 14 days.

■ Xerostomia

Tab. pilocarpine, 5 mg PO TDS with food.

Or

Tab. cevimeline, 30 mg PO TDS.

■ Sialorrhoea

Tab. glycopyrrolate, 0.5 mg PO TDS.

Or

Scopolamine transdermal patch 1.5 mg/day

Or

Tab. diphenhydramine, 25–50 mg PO.

Or

Botulinum toxin A—single injection (10–40 U) into the salivary glands under ultrasound guidance.

■ Aphthous Ulcer

2–4% topical lignocaine ointment/jelly to be applied on the affected area. In severe cases, topical betamethasone valerate/clobetasol propionate.

■ Herpetic Gingivitis/Labialis/Stomatitis

Tab. acyclovir, 200–800 mg PO 5 times daily for 7 days.

■ Halitosis (Oral Malodour)

Chlorhexidine mouth wash: Rinse the mouth 2–3 times/day for at least 30 seconds. Other mouthwashes containing zinc chloride and triclosan can also be used.

■ Prophylaxis of Endocarditis in Patients with Cardiac Lesion Before Dental Procedures

Cap. amoxicillin, 2 g PO 1 h before the procedure.

Or

Cap. clindamycin, 600 mg PO 1 h before the procedure.

Or

Tab. cefadroxil, 2 g PO 1 h before the procedure.

Or

Cap. azithromycin, 500 mg PO 1 h before the procedure.

Or

Inj. cefazolin, 1 g i.m./i.v. 30 min before the procedure.

■ Scurvy

Tab. ascorbic acid, 500 mg PO BD.

■ Rickets

Cap. alfacalcidol, 1 mcg PO daily.

Or

Cap. calcitriol, 0.25–1 mcg PO daily.

■ Fracture Mandible (For Pain Relief)

Inj. morphine, 10 mg slow i.v.

Or

Inj. ketorolac, 30 mg i.m.

Or

Inj. pethidine, 100 mg i.v.

Or

Inj. tramadol, 50–100 mg i.m./slow i.v.

■ Trigeminal Neuralgia

Tab. carbamazepine, 200 mg PO QID.

Or

Tab. phenytoin, 300–400 mg PO daily.

■ Hepatitis B (Pre-exposure Prophylaxis)

Inj. recombinant hepatitis B vaccine, 10 mcg injected into the deltoid muscle at 0, 1 and 6 months.

■ Rabies (Post-exposure Prophylaxis)

Inj. human diploid cell vaccine (HDCV), 1 mL injected into the deltoid on days 0, 3, 7, 14 and 28 (5 doses).

■ Tetanus (Post-exposure Prophylaxis)

Two doses of inj. tetanus toxoid, 0.5 mL injected into the deltoid muscle at an interval of 2 months. First booster dose is given 1 year after the second dose. Second booster is given 5 years after the first booster.

Table A2: Oral Side Effects of Some Drugs

Acarbose	Taste disturbances
Alendronate	Oral ulceration
ACE inhibitors	Taste disturbances, angioedema
Aspirin	Oral ulceration
Cholinergic agonists	Hypersalivation
Carbamazepine	Sore throat, lichenoid reactions
Clonidine	Xerostomia, salivary gland pain
Chloroquine	Oral mucosal pigmentation, lichenoid reactions
Cisplatin	Taste disturbances
Cyclosporine	Gingival swelling
Chlorpromazine	Xerostomia, involuntary facial movements
Clofazimine	Discolouration of saliva
Disulfiram	Halitosis
Gold	Oral ulceration, cheilitis, lichenoid reactions, oral mucosal pigmentation
Glucocorticoids	Oral candidiasis
H ₁ -blockers (first generation)	Xerostomia
Iron	Oral mucosal pigmentation
Iodine	Taste disturbances

Iodides	Hypersalivation
Isoniazid	Cheilitis, trigeminal paraesthesia
Isosorbide dinitrate	Halitosis
Ketamine	Hypersalivation
Lead	Oral mucosal pigmentation
Lithium	Slurred speech, muscle twitchings, orofacial pain
Methyldopa	Xerostomia, salivary gland pain, cheilitis, oral mucosal pigmentation
Metronidazole	Metallic taste
Oral contraceptives	Oral mucosal pigmentation, gingival swelling
Phenytoin	Gum hypertrophy, halitosis
Potassium chloride	Oral ulceration
Penicillamine	Taste disturbances, oral ulceration
Retinoids	Cheilitis
Rifampin and rifabutin	Discolouration of saliva
Tetracyclines	Taste disturbances, drug-induced oral candidiasis, cheilitis, discolouration of teeth
Tricyclic antidepressants	Xerostomia
Vincristine	Trigeminal paraesthesia
Zidovudine	Oral mucosal pigmentation and ulceration

Index

A

- α -Adrenergic agonists, 60
- Abciximab, 252
- Acarbose, 284
- ACE inhibitors, 99, 120
- Acetylcholine synthesis, 50
- Acute attack of angina/myocardial infarction (MI), 117, 391
- Acute bronchial asthma, 391, 394
- Acute functional constipation, 397
- Acute iron poisoning, 255
- Acute necrotizing ulcerative gingivitis (ANUG, trench mouth), 399
- Acute salicylate poisoning, 206
- Adrenal crisis, 391
- Adrenaline, 81, 83, 214
- Adrenergic agonists
 - (sympathomimetic agents), 75
- Adrenergic drugs
 - (sympathomimetics), 78
 - direct-acting, 81
 - adrenaline
 - (epinephrine), 81, 83
 - dobutamine, 84
 - formoterol, 84
 - isoprenaline (isoproterenol), 83
 - mephentermine, 85
 - methoxamine, 85
 - nasal decongestants, 85
 - noradrenaline, 76, 83
 - phenylephrine, 84
 - salbutamol, 84
 - salmeterol, 84
 - selective α_2 -adrenergic agonists, 85
 - terbutaline, 84
 - indirect-acting, 86
 - amphetamine, 86
 - mixed-acting, 86
 - anorectics (anorexiant), 87
 - dopamine, 87
 - ephedrine, 86
 - Adrenergic receptor blockers, 88
 - Adrenergic receptors, 77
 - distribution of, 78
 - Adrenergic transmission, 75
 - drugs affecting, 76
 - Adverse drug reactions, 36
 - adverse effect, 36
 - carcinogenicity and mutagenicity, 39
 - drug allergy, 36
 - type I hypersensitivity, 37
 - type II hypersensitivity, 37
 - type III hypersensitivity, 38
 - type IV hypersensitivity, 38
 - drug dependence, 38
 - iatrogenic diseases, 39
 - idiosyncrasy, 38
 - photosensitivity reactions, 39
 - secondary effects, 36
 - side effects, 36
 - teratogenicity, 39
 - toxic effects, 36
 - Adverse effects of toothpaste, 375
 - Agents affecting calcium balance, 288
 - Alcohols (ethanol and methanol), 165
 - actions of, 166
 - acute ethanol overdosage (acute alcohol intoxication), 166
 - chronic alcoholism, 166
 - methanol poisoning (methyl alcohol poisoning), 167
 - therapeutic uses, 166
 - Aldosterone, 270
 - Alkylating agents, 360
 - alkyl sulphonates, 361
 - busulphan, 361
 - nitrosoureas, 362
 - nitrogen mustards, 360
 - chlorambucil, 361
 - cyclophosphamide, 360
 - mechlorethamine, 361
 - melfalan, 361
 - platinum-containing compounds, 362
 - cisplatin, 362
 - Allergic cough, 394
 - Alpha-adrenergic blockers, 88
 - irreversible nonselective α -blocker, 88
 - phenoxybenzamine, 88
 - reversible nonselective α -blocker, 90
 - phentolamine, 90
 - tolazoline, 90
 - selective α_1 -blockers, 90
 - alfuzosin, 90
 - doxazosin, 90
 - prazosin, 90
 - tamsulosin, 90
 - terazosin, 90
 - therapeutic uses of, 91
 - Alteplase, 250
 - Alveolar abscess, 399
 - Alzheimer's disease, 61
 - Amikacin, 321
 - Aminoglycosides, 318
 - aminopenicillins, 312
 - Amlodipine, 114
 - Amoxicillin, 299, 314
 - Ampicillin, 299, 314

- Anabolic steroids, 266
- Anaesthesia stages, 150
- Analgesic ladder, 182
- Analgesics, 176
 - opioid analgesics, 177
 - buprenorphine, 183, 185
 - butorphanol, 183
 - codeine, 181
 - dextropropoxyphene, 183, 184
 - fentanyl, 183, 184
 - methadone, 183, 184
 - morphine, 181, 182
 - nalmefene, 185
 - naloxone, 185
 - naltrexone, 185
 - opioid agonists, 177
 - opioid receptor, 177
 - pentazocine, 183, 185
 - pethidine (meperidine), 181
 - tramadol, 183, 184
- Anaphylactic shock, 37, 82, 127, 391
- Angina and myocardial infarction, 109, 391
 - β -adrenergic blockers, 113
 - calcium channel blockers (CCB), 113
 - adverse effects, 115
 - mechanism of action, 113
 - pharmacokinetics, 114
 - pharmacological actions, 114
 - uses, 114
 - combination therapy, 116
 - β -blockers \times verapamil/diltiazem, 116
 - calcium channel blockers \times nitrates, 117
 - nifedipine (DHPs) \times β -blockers, 116
 - nitrates \times β -blockers (propranolol), 116
 - organic nitrates, 110
 - therapeutic uses, 112
 - potassium channel opener (potassium channel activator), 115
- Angiotensin converting enzyme inhibitors, 99
 - adverse effects, 100
 - contraindications, 100
 - drug interactions, 100
 - mechanism of action, 99
 - pharmacokinetic features, 100
 - pharmacokinetics, 99
 - site of action, 99
 - therapeutic uses, 101
- Angiotensin receptor blockers (ARBs) or angiotensin receptor antagonists, 101, 120
- Angry man, 79
- Antacids, 237
- Anterior pituitary hormone synthesis and release, 260
- Antianginal drugs, 109
- Antianxiety agents, 190
- Antibiotics, 295, 308, 322, 365
- Anticancer antibiotics, 365
 - actinomycin D, 365
 - bleomycin, 365
 - doxorubicin and daunorubicin, 365
 - mithramycin, 365
 - mitomycin C, 365
- Anticancer drugs, 357
 - classification, 358
 - toxicity, 359
- Anticaries agents, 370
- Anticholinergic agents (cholinergic receptor blockers), 63
- Anticoagulants, 244
 - drug interactions, 248
 - oral, 246
 - warfarin, 247
 - parenteral, 244
 - direct thrombin inhibitors, 246
 - fondaparinux, 246
 - heparin, 244
 - low-molecular-weight heparins, 246
 - therapeutic uses of, 249
- Antidepressants, 190
 - comparative features, 192
 - MAO Inhibitors, 193
 - tricyclic antidepressants, 191
 - mechanism of action, pharmacological actions and adverse effects of, 191
 - uses of, 193
- Antidiarrhoeal agent, 228, 397
- Antidiuretics, 138
 - vasopressin, 138
 - vasopressin analogues, 139
- Antidotes, 41
- Antiemetics, 222, 396
 - 5-HT₃ receptor antagonists, 224
 - adjuvant, 227
 - anticholinergics, 223
 - antihistamines (H₁-blockers), 223
 - prokinetic drugs, 225
 - cannabinoids, 227
 - domperidone, 227
 - metoclopramide, 225
 - neuroleptics, 227
- Antiepileptic drugs, 168
 - carbamazepine, 172, 176
 - chemical classification of, 168
 - clinical classification of, 169
 - clonazepam, 174
 - diazepam, 174
 - doses and drug interactions of, 176
 - ethosuximide, 173, 176
 - fosphenytoin, 172
 - gabapentin, 174
 - lamotrigine, 174
 - lorazepam, 174
 - mechanism of action of, 169
 - oxcarbazepine, 172
 - phenobarbitone (barbiturate), 173, 176
 - phenytoin (diphenylhydantoin), 170, 176
 - mechanism of action of, 171
 - pregabalin, 174
 - sodium valproate, 176
 - topiramate, 175
 - valproic acid (sodium valproate), 173
- Antiepileptics - effect on GABA, 170
- Antiepileptics - effect on sodium channel, 169
- Antifibrinolytics, 250
 - epsilon amino-caproic acid (EACA), 250
 - tranexamic acid, 251
- Antifoaming agents, 238
- Antifungal agents, 340
 - allylamine, 346
 - terbinafine, 346
 - amphotericin B, 340
 - azoles, 343
 - fluconazole, 344
 - itraconazole, 346
 - ketoconazole, 344
 - miconazole and

- clotrimazole, 343
 - voriconazole, 346
 - echinocandins, 347
 - caspofungin acetate, 347
 - flucytosine, 342
 - griseofulvin, 341
 - hamycin, 341
 - nystatin, 341
 - topical agents, 347
 - Anti-*Helicobacter pylori* agents, 238
 - Antiherpes agents, 348
 - acyclovir, 348
 - famciclovir, 349
 - ganciclovir, 349
 - penciclovir, 349
 - valacyclovir, 349
 - Antihistamines, 198
 - H₁-receptor antagonists (H₁-blockers), 198
 - first generation, 199
 - second generation, 200
 - Antihypertensive drugs, 97, 393
 - sites of action, 98
 - Anti-influenza agents, 349
 - amantadine, 349
 - oseltamivir, 349
 - zanamivir, 350
 - Antileprotic drugs, 337
 - clofazimine, 338
 - dapsone or diaminodiphenylsulfone, 338
 - rifampin, 338
 - Antimalarial drugs, 353
 - 4-aminoquinoline, 354
 - chloroquine, 354
 - regimens for treatment of malaria, 355
 - Antimetabolites, 362
 - folate antagonist, 362
 - methotrexate (Mtx), 362
 - purine antagonists, 363
 - pyrimidine antagonists, 364
 - fluorouracil (5-FU), 364
 - Antimicrobial agents, 295
 - Antimotility and antisecretory agents, 228
 - Antimuscarinic agents, 64
 - atropine, 64
 - actions of, 65
 - adverse effects, 68
 - contraindications, 68
 - substitutes, 66
 - therapeutic uses of, 67
 - scopolamine, 69
 - Antiplaque agents, 371
 - chlorhexidine, 372
 - enzymes, 372
 - essential oils, 372
 - fluorides, 371
 - metal ions, 372
 - quarternary ammonium compounds, 372
 - sodium lauryl sulphate, 372
 - triclosan, 372
 - Antiplatelet drugs, 251
 - Antipseudomonal agents, 328
 - Antipsychotic drugs, 187
 - adverse effects of, 188
 - atypical, 189
 - chlorpromazine (phenothiazines), 187
 - mechanism of action, pharmacological actions and adverse effects of, 188
 - comparative features of, 189
 - haloperidol, 189
 - Antiretroviral agents, 350
 - entry or fusion inhibitors, 352
 - non-nucleoside reverse transcriptase inhibitors (NNRTIs), 351
 - protease inhibitors (PIs), 352
 - nucleoside reverse transcriptase inhibitors (NRTIs), 350
 - didanosine, 351
 - emtricitabine, 351
 - lamivudine, 351
 - stavudine, 351
 - zidovudine [azidothymidine (AZT)], 351
 - Antiseptics and disinfectants, 382
 - acids, 386
 - alcohols, 384
 - aldehydes, 384
 - dyes, 386
 - gases, 387
 - halogens, 385
 - metallic salts, 386
 - nitrofurazone, 387
 - oxidizing agents, 385
 - phenols and related agents, 383
 - surface active agents (surfactants), 387
 - Antithyroid drugs, 263
 - β-adrenoceptor blockers (β-blockers), 266
 - iodine and iodides, 265
 - radioactive iodine, 265
 - thioamides, 264
 - Antitubercular drugs, 331
 - first-line, 331
 - ethambutol, 333
 - isoniazid, 331
 - pyrazinamide, 333
 - rifampin (rifampicin), 332
 - streptomycin, 334
 - other, 334
 - second-line, 334
 - cycloserine, 334
 - ethionamide, 334
 - para-aminosalicylic acid (PAS), 334
 - Antiviral agents, 347
 - Anxiety disorders, 395
 - Aphthous ulcer, 399
 - Aqueous humour secretion, 58
 - Aspirin, 204, 210, 252
 - dosage regimen, 206
 - Astringents, 369
 - Autacoids, 197
 - Autonomic nervous system, 47
 - divisions of, 48
 - Autonomic pharmacology, 47
 - Azithromycin, 299, 327
- ## B
- Bacillary dysentery, 397
 - Bactericidal agents, 295
 - Bacteriostatic agents, 295
 - Barbiturates, 147
 - adverse effects, 148
 - drug interactions, 148
 - mechanism of action, 147
 - pharmacological actions and uses, 147
 - Beclomethasone, 270
 - Belladonna poisoning, 61
 - Benzathine penicillin G, 299, 310
 - Benzodiazepine antagonist, 146
 - Benzodiazepines, 143
 - adverse effects, 145
 - important features, 146
 - mechanism of action, 143
 - pharmacokinetics, 145

- pharmacological actions, 144
 - therapeutic uses, 144
 - Beta-adrenergic
 - blockers, 59, 91, 103, 113
 - adverse effects, 93
 - β -blockers with additional
 - vasodilatory action, 96
 - carvedilol, 96
 - celiprolol, 96
 - labetalol, 96
 - classification, 92
 - drug interactions, 93
 - important features, 95
 - mechanism of action, 92
 - pharmacokinetics, 93
 - pharmacological actions, 92
 - selective β_1 -adrenergic
 - blockers, 95
 - atenolol, 96
 - esmolol, 95
 - therapeutic uses, 94
 - Betamethasone, 270
 - Bipolar disorder, 194
 - Bisphosphonates, 293
 - β -lactam antibiotics, 308
 - β -lactamase inhibitors, 314
 - uses, 314
 - Bleaching agents, 376
 - Bleeding after tooth extraction, 398
 - Blood pressure, 97
 - Botulinum toxin A, 75
 - Broad-spectrum antibiotics, 322
 - Budesonide, 270
- C**
- Calcitonin, 290
 - Calcium, 288
 - Calcium channel blockers
 - (CCBs), 102, 113
 - Carbapenems, 317
 - Carbonic anhydrase inhibitors, 59
 - Cardiac failure, 394
 - Cefazolin, 299
 - Central nervous system, 141
 - neurotransmitters, 141
 - excitatory postsynaptic
 - potential (EPSP), 141
 - inhibitory postsynaptic
 - potential (IPSP), 141
 - Cephalexin, 299
 - Cephalosporins, 315
 - Cheese reaction, 193
 - Chelating agents, 381
 - calcium disodium edetate, 382
 - deferiprone, 382
 - desferrioxamine
 - (deferoxamine), 382
 - dimercaprol, 381
 - disodium edetate, 381
 - D-penicillamine, 382
 - Chemoprophylaxis, 298
 - chemoprophylactic
 - regimens, 299
 - indications for, 298
 - Chemotherapy, 295
 - Chemotherapy of leprosy, 339
 - schedules, 339
 - Child dose, 32
 - Chloramphenicol, 324
 - Chlorpropamide, 283
 - Chlortetracycline, 323
 - Cholinergic agents
 - (cholinomimetics,
 - parasympathomimetics), 51
 - anticholinesterases, 56, 62
 - adverse effects, 58
 - irreversible, 62
 - reversible, 56
 - therapeutic uses of
 - reversible, 58
 - choline esters, 52
 - acetylcholine, 52
 - bethanechol, 55
 - cholinomimetic alkaloids, 55
 - arecoline, 56
 - muscarine, 56
 - pilocarpine, 55
 - Cholinergic receptors, 51
 - Cholinergic system, 48
 - Cholinesterases, 50
 - Cimetidine, 235
 - Ciprofloxacin, 307
 - Clarithromycin, 326, 327
 - Classification of antimicrobial
 - agents, 295
 - Clindamycin, 299, 329
 - Clopidogrel, 252
 - Coagulation cascade, 245
 - Combination of antimicrobial
 - agents, 300
 - Combined effects of drugs, 29
 - additive effect, 29
 - chemical antagonism, 30
 - physical antagonism, 30
 - physiological (functional)
 - antagonism, 30
 - potentiation (supra-additive), 29
 - receptor antagonism, 30
 - competitive, 30
 - noncompetitive, 31
 - synergism, 30
 - Comparative features of esters and
 - amides, 162
 - Competitive antagonism, 180
 - Congestive cardiac failure, 117, 394
 - Congestive cardiac failure-
 - pathophysiology, 118
 - Conjugation, 297
 - Conscious sedation, 156
 - Corticosteroids, 267
 - adverse reactions, 273
 - classification and important
 - features of, 268
 - pharmacological actions, 271
 - relative contraindications, 276
 - synthesis and secretion of, 267
 - therapeutic uses, 274
 - Cortisone, 269
 - Cotrimoxazole, 304
 - adverse effects, 305
 - mechanism of action, 304
 - pharmacokinetics, 305
 - preparations of, 305
 - therapeutic uses, 305
 - Coxibs, 209
 - Curare poisoning and reversal
 - of nondepolarizing
 - neuromuscular blockade, 61
 - Cyclooxygenases, 201
- D**
- Dantrolene, 75
 - Definitive therapy, 299
 - Demeclocycline, 323
 - Dental caries, 367
 - prevention, 371
 - Dental tray, 392
 - Dentifrices, 373
 - active ingredients, 373

- inactive ingredients, 374
 - uses, 375
 - Depolarization, 142
 - Desensitising agents, 369
 - Desflurane, 152
 - Desoxycorticosterone acetate, 270
 - Dexamethasone, 270
 - Diabetes mellitus, 276
 - Diabetic ketoacidosis, 282
 - Diarrhoea, 228
 - Diclofenac, 208
 - Digitalis, 120
 - Dihydropyridines (DHPs), 114
 - Dilling's formula, 32
 - Diltiazem, 114, 116
 - Dipyridamole, 252
 - Disclosing agents, 375
 - Diuretics, 101, 119, 130
 - carbonic anhydrase inhibitors, 131
 - loop, 102
 - loop diuretics (high-ceiling diuretics), 133
 - osmotic diuretics, 132
 - potassium-sparing diuretics, 136
 - amiloride and triamterene (directly acting drugs), 137
 - spironolactone (aldosterone antagonist), 136
 - thiazide, 102
 - thiazides (benzothiadiazides) and thiazide-like diuretics, 135
 - Dose for an individual, 32
 - Dose–response curves, 28
 - Dose–response relationship, 27
 - DOTS, 335
 - Doxycycline, 323
 - Dronabinol, 227
 - Drug dosage forms, 43
 - injectable, 45
 - liquid, 44
 - new drug-delivery systems, 45
 - semisolid, 44
 - solid, 43
 - Drug efficacy, 29
 - Drug interactions, 34
 - pharmaceutical interactions, 35
 - pharmacodynamic, 36
 - pharmacokinetic, 35
 - Drug nomenclature, 2
 - Drug potency, 29
 - Drugs affecting coagulation and bleeding, 241
 - Drugs that inhibit gastric acid secretion, 233
 - Drugs used in anaerobic infections, 329
 - Drugs used in congestive cardiac failure, 117
 - ACE inhibitors, 120
 - angiotensin-receptor blockers (ARBs), 120
 - β -blockers, 120
 - cardiac glycosides, 120
 - adverse effects, 122
 - drug interactions, 123
 - mechanism of action, 121
 - pharmacokinetics, 122
 - pharmacological actions, 122
 - toxicity, 123
 - treatment of digoxin toxicity, 123
 - uses, 123
 - diuretics, 119
 - sympathomimetic amines, 124
 - dobutamine, 124
 - dopamine, 124
 - phosphodiesterase inhibitors, 125
 - vasodilators, 119
 - Drugs used in peptic ulcer, 396
 - Drugs used in treatment of
 - bronchial asthma, 213
 - anti-IgE monoclonal antibody, 218
 - bronchodilators, 214
 - anticholinergics, 216
 - methylxanthines, 215
 - sympathomimetics, 214
 - glucocorticoids, 217
 - leukotriene antagonists, 216
 - mast cell stabilizers, 217
 - Drugs used in treatment of
 - cough, 211
 - antitussives, 212
 - expectorants (mucokinetics), 212
 - mucolytics, 212
 - pharyngeal demulcents, 212
 - Drug treatment of medical emergencies, 391
 - Dry cough, 394
- ## E
- ED₅₀, 28
 - Edrophonium, 57
 - Eicosanoids, 201
 - Emetics, 221
 - Empirical therapy, 299
 - Endogenous opioid peptides, 186
 - Enzyme, 365, 372
 - L-asparaginase, 365
 - Enzyme induction, 17
 - Enzyme inhibition, 17
 - Ephedrine, 65, 86
 - Epilepsies, 168
 - Eptifibatide, 252
 - Erythromycin, 326, 327
 - Ethambutol, 333, 335
 - Ether, 151
- ## F
- Factors influencing drug dosage, 20
 - Factors modifying drug action, 31
 - drug factors, 31
 - patient factors, 32
 - Fainting, 391
 - Famotidine, 235
 - Felodipine, 114
 - Fibrinolytics (thrombolytics), 249
 - Fight–fright–flight, 79
 - First-order kinetics, 19
 - First-pass metabolism, 11
 - Fixed-dose combination, 21
 - Fludrocortisone, 270
 - Flumazenil, 146
 - Fluorides, 367, 370
 - actions on teeth, 367
 - fluoride toxicity, 368
 - use of fluorides, 367
 - fluoridated toothpaste, 367
 - fluoridation of drinking water, 367
 - fluoride mouthrinse, 368
 - fluoride supplements, 368
 - fluoride varnish, 368
 - gel and foam, 368
 - Fluoroquinolones, 307
 - Fluticasone, 270

- Folic acid, 256, 390
 Formoterol, 84, 214
 Fortified procaine penicillin G, 310
 Fracture mandible (for pain relief), 400
 Framycetin (soframycin), 321
 Fusidic acid, 330
- G**
- Ganglionic blockers, 69
 Gastric secretion, 232
 Gastroesophageal reflux disease, 232
 General anaesthesia, 149
 in dentistry, 150
 General anaesthetics, 149
 classification, 151
 inhalational anaesthetics, 151
 parenteral, 154
 benzodiazepines, 155
 ketamine, 155
 opioid analgesics, 155
 propofol, 155
 thiopentone sodium, 154
 Generalized tonic-clonic seizures (grand mal epilepsy), 395
 Gentamicin, 320
 Glaucoma, 58
 drugs for, 59
 Glibenclamide (glyburide), 283
 Gliclazide, 283
 Glimepiride, 283
 Glipizide, 283
 Glucocorticoids, 269
- H**
- H₁-antihistamines, 200
 H₂-receptor antagonists (H₂-blockers), 235
 Haematinics, 252
 folic acid, 256
 iron, 253
 absorption and storage, 253
 factors affecting iron absorption, 254
 pharmacokinetics, 253
 preparations of, 254
 therapeutic uses of, 254
 vitamin B₁₂, 255
 Haemocoagulase enzyme complex, 391
 Haemostatic agents, 241
 local haemostatics (styptics), 241
 systemic agents, 242
 Halitosis (oral malodour), 400
 Halogenated anaesthetics, 152
 Halothane, 151, 152
Helicobacter pylori, 238
 quadruple therapy, 239
 triple therapy, 239
Helicobacter pylori infection, 396
 Hepatitis B (pre-exposure prophylaxis), 401
 Herpetic gingivitis/labialis/stomatitis, 400
 Histamine, 197
 betahistine, 198
 Hormonal agents, 366
 Hormone, 259
 Hydrocortisone, 269
 Hyperparathyroidism, 290
 Hyperpolarization, 142
 Hypertension, 97
 treatment, 107
 Hypertensive crisis (hypertensive emergencies), 109, 391
 Hyperthyroidism, 262
 Hypnotics, 142
 Hypoglycaemia, 391
 Hypoparathyroidism, 290
 Hypotension due to local anaesthetic, 399
 Hypothalamic and pituitary hormones, 260
 Hypothalamic regulatory hormones, 260
 Hypothyroidism, 262
- I**
- Ibuprofen, 208
 Indomethacin, 208
 Inhalational devices, 218
 Injectable routes of drug administration, 6
 Insomnia, 395
 Insomnia due to toothache, 398
 Insulin, 276
 actions of, 278
 administration, 281
 complications, 282
 concentration, 281
 drug interactions, 282
 indications, 281
 mechanism of action, 279
 mixed insulin preparations, 281
 onset and duration of action, 280
 pharmacokinetics, 279
 preparations, 279
 regimen, 281
 secretion regulation, 277
 therapy, 281
 Iron-deficiency anaemia, 397
 Isoflurane, 152
 Isoniazid, 331, 335
 Isradipine, 114
- K**
- Ketorolac, 208
- L**
- Lactulose in hepatic coma, 232
 Laxatives, 229
 bulk-forming, 229
 osmotic/saline, 231
 lactulose, 231
 stimulant (irritant), 230
 anthraquinone derivatives, 231
 bisacodyl, 230
 phenolphthalein, 230
 sodium picosulphate, 230
 stool softeners (stool-wetting agents), 230
 docusates, 230
 liquid paraffin, 230
 uses of, 232
 LD₅₀, 28
 Lepra reaction, 339
 Leprosy, 337
 Levofloxacin, 307
 Linezolid, 330
 Lipid-lowering agent, 394
 List of microorganisms, 300
 Lithium, 195
 Local anaesthetics, 157
 adverse effects, 160
 articaine, 161, 162
 basic structure, 157

benoxinate, 162
 benzocaine and butylaminobenzoate, 162
 bupivacaine, 160, 161
 chloroprocaine, 161
 classification, 158
 cocaine, 161
 combination of vasoconstrictor with, 159
 complications of, 164
 dibucaine, 161, 162
 drug interactions, 165
 dyclonine, 163
 eutectic mixture, 162
 factors affecting local anaesthetic action, 159
 felypressin, 159
 lignocaine, 161, 162
 mechanism of action, 158
 mepivacaine, 161
 methods of administration and uses, 163
 oxethazaine, 162
 pharmacokinetics, 160
 pharmacological actions, 160
 prilocaine, 161, 162
 procaine, 161, 162
 properties, 161
 ropivacaine, 160, 161
 techniques of, 163
 conduction block, 164
 epidural anaesthesia, 165
 infiltration anaesthesia, 163
 spinal anaesthesia, 164
 surface anaesthesia (topical anaesthesia), 163
 tetracaine, 160, 161

M

Macrolides, 326
 antibacterial spectrum and therapeutic uses, 327
 comparative features, 327
 Mean arterial pressure, 97
 Mefenamic acid, 208
 Metformin, 283
 Methacycline, 323
 Methods to prolong the duration of drug action, 22
 Methyl-prednisolone, 269
 Mineralocorticoids, 270

Minimum inhibitory concentration, 295
 Minocycline, 323
 Miotics, 60
 Miscellaneous antibacterial agents, 329
 Monobactams, 318
 Motion sickness, 397
 Mouthwashes (mouthrinses), 378
 side effects, 380
 uses, 380
 Moxifloxacin, 307
 Multi-drug therapy (MDT), 334
 Mummifying agents, 378
 Muscarinic and nicotinic receptor, 51
 Myasthenia gravis, 60
 Myocardial infarction, 109, 117, 391, 394
 Myxedema, 262

N

Nateglinide, 284
 Neomycin, 321
 Neostigmine, 57
 Netilmicin, 321
 Neuroses, 187
 Nicardipine, 114
 Nifedipine, 114
 Nimodipine, 114
 Nisoldipine, 114
 Nitroglycerin, 111
 Nitroimidazoles, 355
 metronidazole, 355
 ornidazole, 357
 satranidazole, 357
 secnidazole, 357
 tinidazole, 357
 Nitrous oxide, 151
 Non-benzodiazepine hypnotics, 148
 eszopiclone, 149
 zaleplon, 149
 zolpidem, 148
 zopiclone, 149
 Noradrenaline - synthesis and release, 76
 Nonsteroidal antiinflammatory drugs, 203
 clinical uses, 207
 important features, 208
 Norfloxacin, 307

O

Obtundents, 377
 Ofloxacin, 307
 Omalizumab, 218
 Opioid analgesics, 395
 Oral antidiabetic drugs, 282
 α -glucosidase inhibitors, 287
 biguanides, 285
 adverse effects, 286
 mechanism of action, 285
 pharmacokinetics, 286
 use, 286
 dosage and duration of action, 283
 D-phenylalanine derivative, 286
 meglitinide analogue, 286
 newer drugs, 287
 DPP-4 (dipeptidyl peptidase-4) inhibitors, 287
 GLP-1 receptor agonists, 287
 sulfonylureas, 284
 adverse effects, 285
 drug interactions, 285
 mechanism of action, 284
 pharmacokinetics, 285
 use, 285
 thiazolidinediones, 286
 adverse effects, 287
 pharmacokinetics, 287
 use, 287
 Oral candidiasis (oral thrush), 399
 Oral rehydration solution (ORS), 228
 Oral side effects, 401
 Organophosphorous insecticides, 62
 Organophosphorous poisoning, 62
 Osmotic agents, 59
 Osteoarthritis, 396
 Oximes, 63
 Oxytetracycline, 323

P

Paracetamol, 209
 mechanism of toxicity and treatment, 210
 poisoning, 210
 Parathyroid hormone (PTH), 289
 Pefloxacin, 307
 Penicillin G, 310

- Penicillins, 308
 adverse reactions, 310
 antipseudomonal, 314
 classification, 313
 mechanism of action, 308
 mechanism of bacterial
 resistance to, 309
 pharmacokinetics, 309
 preparations, 310
 prophylactic uses, 312
 structure of, 308
 therapeutic uses, 311
- Peptic ulcer, 232
- Pharmacodynamics, 23
 mechanism of drug action, 23
 nonreceptor-mediated, 23
 receptor-mediated, 24
 types of drug action, 23
- Pharmacokinetics, 9
 bioavailability, 11
 biotransformation (drug
 metabolism), 14
 drug-metabolizing
 enzymes, 16
 pathways of drug
 metabolism, 15
 prodrug, 14
 drug absorption, 9
 effect of pH and
 ionization, 10
 drug distribution, 11
 apparent volume of, 12
 blood–brain barrier, 13
 drug reservoirs or tissue
 storage, 13
 placental barrier, 13
 plasma protein binding, 13
 redistribution, 12
 drug excretion, 17
 pharmacokinetic parameters, 18
 clearance, 19
 plasma half-life ($t/2$), 18
 steady state concentration, 20
- Pharmacotherapy of acute
 myocardial infarction, 117
- Pharmacovigilance, 40
- Phenylephrine, 65
- Physostigmine (eserine), 57
- Pioglitazone, 284
- Piroxicam, 208
- Plasma expanders, 125
 degraded gelatin polymer, 126
 dextran, 125
 human albumin, 125
 hydroxyethyl starch or
 hetastarch, 125
 polyvinylpyrrolidone, 126
- Post-extraction pain with
 swelling, 398
- Postoperative urinary retention and
 paralytic ileus, 61
- Preanaesthetic medication, 156
- Prednisolone, 269
- Prednisone, 269
- Prevention of caries, 371
- Prinzmetal's angina, 109
- Procaine penicillin G, 310
- Proinsulin, 277
- Prophylaxis of endocarditis in
 patients with cardiac lesion
 before dental procedures, 400
- Prophylaxis of HIV infection, 398
- Propranolol, 96, 116
- Prostaglandin analogues, 236
- Prostaglandins, 60, 201
 effects and uses of, 203
 preparations and uses of, 202
- Proton pump inhibitors (PPIs), 233
- Psychopharmacology, 186
- Psychoses, 187
- Pulmonary tuberculosis, 398
- Pulse pressure, 97
- Pyrazinamide, 333, 335
- Pyridostigmine, 57
- Q**
- Quinolones, 306
 adverse effects, 306
 antibacterial spectrum, 306
 drug interactions, 307
 mechanism of action, 306
 pharmacokinetics, 306
 uses, 308
- R**
- Rabies (post-exposure
 prophylaxis), 401
- Ranitidine, 235
- Receptor families, 25
 enzyme-linked receptors, 27
 G-protein-coupled receptors
 (metabotropic receptors), 25
 ligand-gated ion channels
 (inotropic receptors), 25
 nuclear receptors, 27
- Redistribution of thiopentone, 154
- Regulation of receptors, 27
- Repaglinide, 283
- Resistance to antimicrobial
 agents, 296
 cross-resistance, 297
 mechanism of development
 of, 297
 prevention of development
 of, 297
- Respiratory system, 211
- Rickets, 400
- Rifampicin, 299
- Rifampin, 332, 335, 338
- Routes of drug administration, 3
 enteral, 4
 oral, 4
 rectal, 5
 sublingual, 5
 local, 3
 parenteral, 5
 inhalation, 6
 injections, 6
 special drug-delivery systems, 8
 systemic, 4
- Roxithromycin, 327
- S**
- Salbutamol, 84, 214
- Salicylism, 206
- Salmeterol, 84, 214
- Scurvy, 400
- Sedatives, 142
- Seizures, 168
- Seizures (epileptic/drug
 induced), 391
- Selection of an appropriate
 antimicrobial agent, 301
 drug factors, 302
 organism-related factors, 302
 patient factors, 301
- Selective β_2 -agonists, 214
- Selective COX-2 inhibitors, 209
- Semisynthetic penicillins, 312

- Severe bleeding following dental procedures, 391
- Sevoflurane, 152
- Shock, 126
 - management, 127
 - anaphylactic shock, 127
 - cardiogenic shock, 127
 - hypovolaemic shock, 127
 - neurogenic shock, 127
 - septic shock, 127
 - types and causes, 126
- Sialorrhoea, 399
- Sitagliptin, 284
- Skeletal muscle relaxants, 70
 - centrally acting, 71
 - directly acting, 75
 - neuromuscular blockers, 71
 - competitive blockers (non-depolarizing blockers), 73
 - depolarizing blockers, 71
 - factors affecting the action of, 74
 - reversal of action of
 - competitive, 74
 - uses, 74
- Sleep, 142
 - disorders, 143
- Somatic nervous system, 47
- Sources of drug information, 2
- Sources of drugs, 3
- Stages of anaesthesia, 150
- Status asthmaticus, 218, 391
- Status epilepticus, 175, 395
- Streptococcal pharyngitis, 398
- Streptokinase, 250
- Streptomycin, 320, 334, 335
- Succinylcholine, 71
- Sulphonamides, 302
 - adverse effects, 304
 - bacterial resistance to, 303
 - basic structure, 302
 - drug interactions, 304
 - mechanism of action, 303
 - pharmacokinetics, 303
 - therapeutic uses, 304
- Superinfection (suprainfection), 297
 - factors predisposing to, 298
 - microorganisms causing, 298
 - pathogenesis, 298
- Sympathetic and parasympathetic stimulation, 49
- Sympathetic overactivity, 79
- Sympatholytics, 103
 - α -adrenergic blockers, 105
 - β -adrenergic blockers, 103
 - centrally acting
 - sympatholytics, 103
 - α -methyldopa, 104
 - clonidine, 103
- Sympathomimetics, 75, 78, 80, 214
- Synthesis of acetylcholine, 50
- ## T
- T₃, 263
- T₄, 263
- Taxanes, 364
- Teicoplanin, 330
- Terbutaline, 214
- Tetanus (post-exposure prophylaxis), 401
- Tetany, 391
- Tetracyclines, 322
 - adverse effects, 323
 - important features, 323
 - mechanism of action, 322
 - pharmacokinetics, 322
 - resistance, 322
 - structure of, 322
 - therapeutic uses, 323
- Therapeutic drug monitoring, 21
- Therapeutic index, 28
- Therapeutic window, 29
- Thiopentone redistribution, 154
- Thyroid hormones, 261
 - mechanism of action, 263
 - preparations, 263
 - synthesis and release, 261
 - therapeutic uses, 263
- Thyrotoxic crisis (thyroid storm), 266, 391
- Thyrotoxicosis, 262
- Thyroxine, 263
- Ticlopidine, 252
- Tirofiban, 252
- Tobramycin, 321
- Tolbutamide, 283
- Tolerance, 33
- Tonsillitis, 398
- Toothache in patient with peptic ulcer, 398
- Transdermal drug-delivery system, 8
- Transduction, 296
- Transformation, 296
- Treatment of acute severe asthma, 218
- Treatment of HIV infection, 352
- Treatment of hypertension, 107
 - dosage and indications, 108
 - drugs to be avoided, 108
 - preferred drugs, 108
- Treatment of poisoning, 40
- Treatment of tuberculosis, 334
 - chemoprophylaxis, 337
 - extensively drug-resistant (XDR) tuberculosis, 336
 - HIV patients, 336
 - multidrug-resistant tuberculosis (MDR-TB), 336
 - pregnancy, 336
 - role of glucocorticoids, 337
 - route and doses, 335
 - WHO guidelines, 335
 - WHO-recommended treatment regimens, 336
- Triamcinolone, 269
- Trigeminal neuralgia, 401
- Triiodothyronine, 263
- Triple-drug therapy, 396
- Type-2 diabetes mellitus, 397
- ## U
- Ulcer protectives, 236
 - bismuth-containing preparations, 237
 - sucralfate, 236
- Urine formation, 129
- Urokinase, 250
- ## V
- Vancomycin, 330
- Vanillylmandelic acid, 91
- Vasodilators, 106, 119
 - hydralazine, 106
 - minoxidil, 106
 - sodium nitroprusside, 106
 - mechanism of action and effects, 107

- Verapamil, 114
 - Vinca alkaloids, 364
 - Vitamin A (retinol), 388
 - Vitamin B₁ (thiamine), 389
 - Vitamin B₂ (riboflavin), 389
 - Vitamin B₃ (niacin), 389
 - Vitamin B₆ (pyridoxine), 389
 - Vitamin B₁₂, 390
 - Vitamin C (ascorbic acid), 390
 - Vitamin D, 291, 388
 - actions of vitamin D, 292
 - pathways of vitamin D
 - production, 291
 - preparations of vitamin D, 292
 - therapeutic uses, 292
 - Vitamin E (α -tocopherol), 388
 - Vitamin K, 242, 388
 - Vitamin K in clotting, 247
 - Vitamins, 387
 - fat-soluble, 388
 - water-soluble, 389
 - Vomiting, 221
 - central and visceral structures involved, 222
 - mechanism of, 221
- X**
- Xerostomia, 399
- Y**
- Young's formula, 32
- Z**
- Zero-order kinetics, 20
 - Zona fasciculata, 267
 - Zona glomerulosa, 267
 - Zona reticularis, 267